

EIKI

MULTIMEDIA PROJECTOR

MODEL **LC-X6A**
LC-SX6A

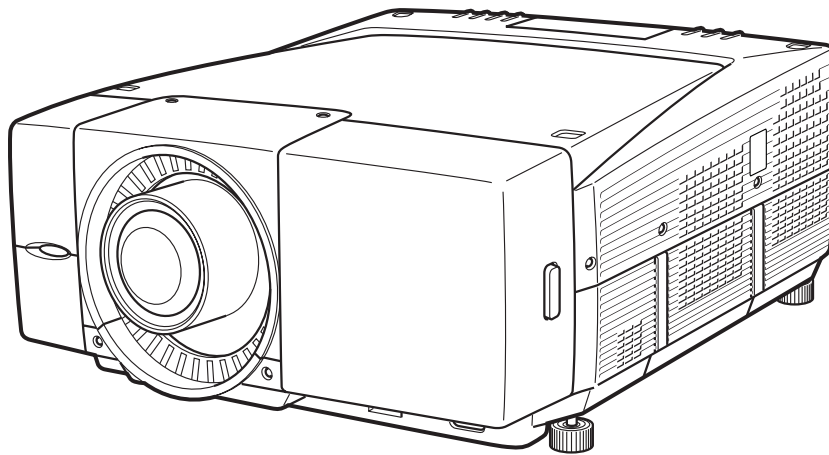

* Projection lens is optional.

OWNER'S MANUAL

Features and Design

This Multimedia Projector is designed with most advanced technology for portability, durability, and ease of use. This projector utilizes built-in multimedia features, a palette of 16.77 million colors, and matrix liquid crystal display (LCD) technology.

◆ **Compatibility**

The projector widely accepts various video and computer input signals including Analog and Digital Computer sources, 6 TV color systems, Component video, S-video, Digital video sources compatible with HDCP, and RGB scart. (☞ p36 and 37)

◆ **Simple Computer System Setting**

The projector has the Multi-scan system to conform to almost all computer output signals quickly. The projector accepts signals up to UXGA resolution. (☞ p38 and 70)

◆ **Convenient Fingertip Control Pad**

The fingertip Control Pad on the remote control provides you a remarkable flexibility and simplicity through the On-Screen Menu navigation. (☞ p14, 33, and 34)

◆ **Easy Menu Operation with USB Mouse**

Your USB Mouse Controller can be used for the projector's menu operation. (☞ p25, 33, and 34)

◆ **Vertical and Horizontal Lens Shift and Memory**

The projector is equipped with vertical and horizontal Lens Shift and Lens Memory function, which enables you to obtain optimum image easily under various setup environments. (☞ p29 and 53)

◆ **One-Touch Removable Filter and Filter LED**

One-touch removable filter allows you an easy maintenance and the orange lighting filter LED tells you the best filter exchange timing. (☞ p61)

◆ **My Logo**

The projector enables you to customize the starting or interval display for your presentation with its image capturing function. (☞ p50)

◆ **My Menu Selection**

My Menu function allows you to select menu items to be displayed on screen. You can hide menus not in frequent use and make your own menu display. (☞ p49)

◆ **Customized Screen Setting**

Fine aspect setting menu is prepared in the projector. You can adjust screen scale and position exactly what you want. (☞ p47)

◆ **Shutter Function**

The projector is equipped with the shutter that provides complete blackness for a while the projected image is not needed with keeping the projector on. The Shutter management function allows you to set the timer. It prevents leaving the projector on with the shutter closed for a long time. (☞ p29, 53, and 54)

◆ **Film Function**

The Film function reproduces pictures faithful to the original film quality from 2:3 and 2:2 pull-down video sources. (☞ p46)

◆ **Various Security Functions**

The following security or anti-theft functions prevent others except users from using the projector: Key Lock, PJ Lock, and USB Lock. (☞ p27, 54, and 55)

◆ **Advanced Network Feature**

Advanced Network feature available by installation of the optional interface board enables various networking operations including Network Capture, Network Viewer, Network Communication, and Advanced Card Imager. Contact the sales dealer where you purchase the projector for the Advanced Network board. (☞ p73)

Trademarks

Each name of corporations or products in this book is either a registered trademark or a trademark of its respective corporation.

Remark

Any graphic and figure in this manual are subject to change without notice.

Table of Contents

Features and Design	2	D. Zoom +/- Function	32
Table of Contents	3	How to Operate On-Screen Menu	33
To The Owner	4	Menu Icons and Their Features	35
Safety Instructions	5	Input	36
Air Circulation	6	Input	36
Setup In Proper Directions	6	System	38
Moving the Projector	7	System	38
Caution in Handling the Projector	7	PC System Selection	38
Compliance	8	Video or S-Video Signal Selection	39
Preparation	9	Component Signal Selection	39
Parts Name	9	Computer Adjustment	40
Indicators	10	PC Adjustment	40
Top Control	11	Auto PC Adjust	40
Terminals	12	Manual PC Adjust	41
Remote Control	14	Image Adjustment	43
Remote Control Transmitter	16	Image	43
Remote Control Channel and ID Setup	16	Image Adjust	44
Remote Control Battery Installation	17	Screen Setting	47
Installation	18	Screen Setting	47
Installation	18	Setting	49
Lens Installation	18	Setting	49
Positioning the Projector	18	Special	57
Lens Shift Adjustment	19	Special	57
Level Adjustable Feet	19	Information	59
Connecting AC Power Cord	20	Maintenance and Cleaning	60
Connection Terminals	21	Warning Temp Indicator	60
Interface Board Slots	21	Air Filter Replacement	61
Connecting to Computer	22	Lamp Replacement	62
(Digital and Analog RGB)	22	Cleaning the Projection Lens	64
Connecting to Video Equipment	23	Cleaning the Projector Cabinet	64
(Digital and Video)	23	Attaching the Cord Cover Strap	64
Connecting to Video Equipment	24	Indicators and Projector Condition	65
(Component and RGB Scart)	24	Main Indicators	65
Basic Operation	25	Shutter Indicator	66
Operating the Projector	25	Warning Filter Indicator	66
Basic Operation and Reference Buttons	26	Lamp Replace Indicators	67
Turning On the Projector	27	Appendix	68
Turning Off the Projector	28	Troubleshooting	68
Lens Shift Adjustment	29	Compatible Computer Specifications	70
Zoom and Focus Adjustment	29	Technical Specifications	72
Shutter Function	29	Optional Parts	73
Input Selection	30	Menu Tree	74
Auto PC Adjustment	30	Dimensions	77
Information	30	Terminal Configurations	78
Keystone Adjustment	31	PIN Code Number Memo	79
Screen Selection	31	Index	80
Picture Freeze Function	31		
P-Timer Function	31		

Before operating this projector, read this manual thoroughly and operate the projector properly.

This projector provides many convenient features and functions. Operating the projector properly enables you to manage those features and maintain it in better condition for a considerable time.

Improper operation may result in not only shortening the product life, but also malfunctions, fire hazard, or other accidents.

If your projector seems to operate improperly, read this manual again, check operations and cable connections and try the solutions in the "Troubleshooting" section in the end of this booklet. If the problem still persists, contact the dealer where you purchased the projector or the service center.

<div style="display: inline-block; text-align: center; background-color: black; color: white; padding: 5px; margin: 0 10px;"> CAUTION RISK OF ELECTRIC SHOCK DO NOT OPEN </div>
<p>CAUTION : TO REDUCE THE RISK OF ELECTRIC SHOCK, DO NOT REMOVE COVER (OR BACK). NO USER-SERVICEABLE PARTS INSIDE EXCEPT LAMP REPLACEMENT. REFER SERVICING TO QUALIFIED SERVICE PERSONNEL.</p>
<p> THIS SYMBOL INDICATES THAT DANGEROUS VOLTAGE CONSTITUTING A RISK OF ELECTRIC SHOCK IS PRESENT WITHIN THIS UNIT.</p>
<p> THIS SYMBOL INDICATES THAT THERE ARE IMPORTANT OPERATING AND MAINTENANCE INSTRUCTIONS IN THE OWNER'S MANUAL WITH THIS UNIT.</p>

NOTE: This symbol mark and recycle system are applied only to EU countries and not applied to the countries in the other area of the world.

Your EIKI product is designed and manufactured with high quality materials and components which can be recycled and reused.

This symbol means that electrical and electronic equipment, at their end-of-life, should be disposed of separately from your household waste.

Please dispose of this equipment at your local community waste collection/recycling centre.

In the European Union there are separate collection systems for used electrical and electronic products.

Please help us to conserve the environment we live in!

Safety Precaution

WARNING : TO REDUCE THE RISK OF FIRE OR ELECTRIC SHOCK, DO NOT EXPOSE THIS APPLIANCE TO RAIN OR MOISTURE.

- This projector produces intense light from the projection lens. Do not stare directly into the lens as much as possible. Eye damage could result. Be especially careful that children do not stare directly into the beam.
- Install the projector in a proper position. If not, it may result in a fire hazard.
- Provide appropriate space on the top, sides and rear of the projector cabinet for allowing air circulation and cooling the projector. Minimum clearances must be maintained. If the projector is to be built into a compartment or similarly enclosed, the minimum distances must be maintained. Do not cover the ventilation slot on the projector. Heat build-up can reduce the service life of your projector, and can also be dangerous.

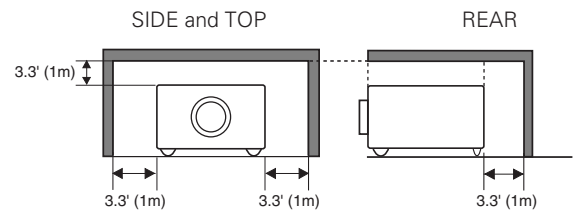

- If the projector is not to be used for an extended time, unplug the projector from the power outlet.

CAUTION ON HANGING FROM THE CEILING

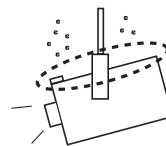

When hanging the projector from the ceiling, clean the air intake vents, air filters, and top of the projector periodically with a vacuum cleaner. If you leave the projector without cleaning for a long time, the dust will block the operation of the cooling function, and it may cause a breakdown or a disaster.

DO NOT SET THE PROJECTOR IN GREASY, WET, OR SMOKY CONDITIONS SUCH AS IN A KITCHEN TO PREVENT A BREAKDOWN OR A DISASTER. IF THE PROJECTOR COMES IN CONTACT WITH OIL OR CHEMICALS, IT MAY BECOME DETERIORATED.

CAUTION

Not for use in a computer room as defined in the Standard for the Protection of Electronic Computer/Data Processing Equipment, ANSI/NFPA 75.

Ne peut être utilisé dans une salle d'ordinateurs telle que définie dans la norme ANSI/NFPA 75 Standard for Protection of Electronic Computer/Data Processing Equipment.

READ AND KEEP THIS OWNER'S MANUAL FOR LATER USE.

Safety Instructions

All the safety and operating instructions should be read before the product is operated.

Read all of the instructions given here and retain them for later use. Unplug this projector from AC power supply before cleaning. Do not use liquid or aerosol cleaners. Use a damp cloth for cleaning.

Follow all warnings and instructions marked on the projector.

For added protection to the projector during a lightning storm, or when it is left unattended and unused for long periods of time, unplug it from the wall outlet. This will prevent damage due to lightning and power line surges.

Do not expose this unit to rain or use near water... for example, in a wet basement, near a swimming pool, etc...

Do not use attachments not recommended by the manufacturer as they may cause hazards.

Do not place this projector on an unstable cart, stand, or table. The projector may fall, causing serious injury to a child or adult, and serious damage to the projector. Use only with a cart or stand recommended by the manufacturer, or sold with the projector. Wall or shelf mounting should follow the manufacturer's instructions, and should use a mounting kit approved by the manufacturers.

An appliance and cart combination should be moved with care. Quick stops, excessive force, and uneven surfaces may cause the appliance and cart combination to overturn.



Slots and openings in the back and bottom of the cabinet are provided for ventilation, to ensure reliable operation of the equipment and to protect it from overheating.

The openings should never be covered with cloth or other materials, and the bottom opening should not be blocked by placing the projector on a bed, sofa, rug, or other similar surface. This projector should never be placed near or over a radiator or heat register.

This projector should not be placed in a built-in installation such as a book case unless proper ventilation is provided.

Never push objects of any kind into this projector through cabinet slots as they may touch dangerous voltage points or short out parts that could result in a fire or electric shock. Never spill liquid of any kind on the projector.

Do not install the projector near the ventilation duct of air-conditioning equipment.

This projector should be operated only from the type of power source indicated on the marking label. If you are not sure of the type of power supplied, consult your authorized dealer or local power company.

Do not overload wall outlets and extension cords as this can result in fire or electric shock. Do not allow anything to rest on the power cord. Do not locate this projector where the cord may be damaged by persons walking on it.

Do not attempt to service this projector yourself as opening or removing covers may expose you to dangerous voltage or other hazards. Refer all servicing to qualified service personnel.

Unplug this projector from wall outlet and refer servicing to qualified service personnel under the following conditions:

- a. When the power cord or plug is damaged or frayed.
- b. If liquid has been spilled into the projector.
- c. If the projector has been exposed to rain or water.
- d. If the projector does not operate normally by following the operating instructions. Adjust only those controls that are covered by the operating instructions as improper adjustment of other controls may result in damage and will often require extensive work by a qualified technician to restore the projector to normal operation.
- e. If the projector has been dropped or the cabinet has been damaged.
- f. When the projector exhibits a distinct change in performance-this indicates a need for service.

When replacement parts are required, be sure the service technician has used replacement parts specified by the manufacturer that have the same characteristics as the original part. Unauthorized substitutions may result in fire, electric shock, or injury to persons.

Upon completion of any service or repairs to this projector, ask the service technician to perform routine safety checks to determine that the projector is in safe operating condition.



Voor de klanten in Nederland

Bij dit produkt zijn batterijen geleverd.

Wanneer deze leeg zijn, moet u ze niet weggoien maar inleveren als KCA.



Air Circulation

Openings in the cabinet are provided for ventilation and to ensure reliable operation of the product and to protect it from overheating, and these openings must not be blocked or covered.

CAUTION

Hot air is exhausted from the exhaust vent. When using or installing the projector, the following precautions should be taken.

- Do not put any flammable objects or spray can near the projector. Hot air is exhausted from ventilation holes.
- Keep the exhaust vent at least 3.3' (1m) away from any objects.
- Do not touch a peripheral part of the exhaust vent, especially screws and metallic part. This area will become hot while the projector is being used.
- Do not put anything on the cabinet. The materials put on the cabinet will not only get damaged but also cause fire hazard by heat.

Cooling fans are provided to cool down the projector. The fan's running speed is changed according to the temperature inside the projector.

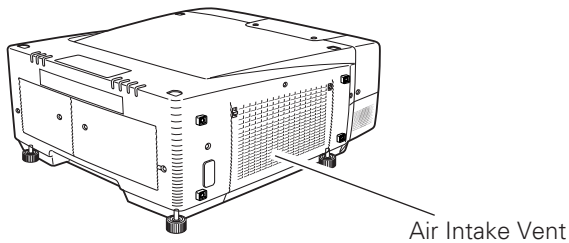
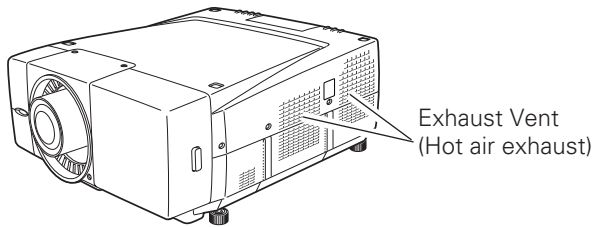

Setup In Proper Directions

Use the projector properly in specified positions. Improper positioning may reduce the lamp life and result in severe accident or fire hazard.

This projector is allowed to project the picture in any position of 360 degrees such as upward, downward, or backward as below.

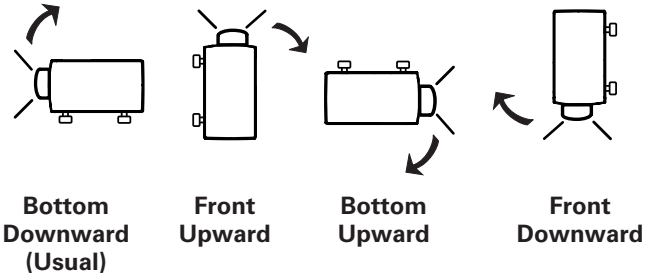

Positioning Precautions

When installing the projector, avoid positioning it as described below:

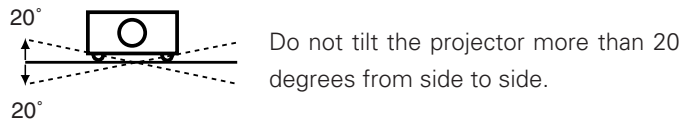

Do not put the projector on either side to project an image.

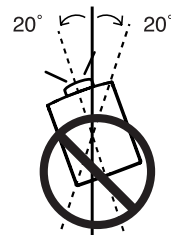

In upward projection, do not tilt the projector over 20 degrees right and left.

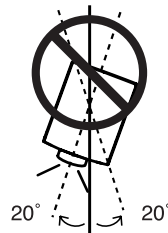

In downward projection, do not tilt the projector over 20 degrees right and left.

Moving the Projector

Carry the projector by two or more people by the carrying handle.



Disconnect all the cables from the projector before moving the projector. Moving the projector with the cables connected may cause damage to the projector or result in serious injury.

Retract the projector's adjustable feet and replace the lens cover to protect the lens surface when moving the projector.



USE CAUTION IN CARRYING OR TRANSPORTING THE PROJECTOR

- Do not drop or bump the projector, otherwise damages or malfunctions may result.
- When carrying the projector, use a suitable carrying case.
- Do not transport the projector by courier or any other transport service in an unsuitable transport case. This may cause damage to the projector. For information about transporting the projector by courier or any other transport service, consult your dealer.



REMOVE LENS FROM THE PROJECTOR WHEN CARRYING. OTHERWISE, IT MAY CAUSE SERIOUS DAMAGE TO LENS AND THE PROJECTOR. WHEN TRANSPORT OR STORE THE PROJECTOR WITHOUT LENS, REPLACE THE LENS COVER PLATE INITIALLY ATTACHED TO THE PROJECTOR. TRANSPORTING OR STORING WITHOUT THE LENS COVER PLATE MAY CAUSE DUST TO GET INSIDE THE PROJECTOR AND RESULT IN MALFUNCTION OF THE PROJECTOR OR DAMAGE OF THE OPTICAL COMPONENTS INSIDE THE PROJECTOR.

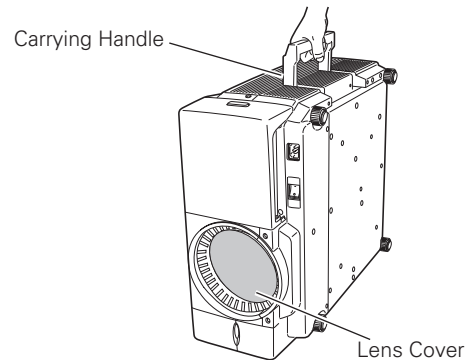

Replace the Lens cover when carrying or not using the projector.

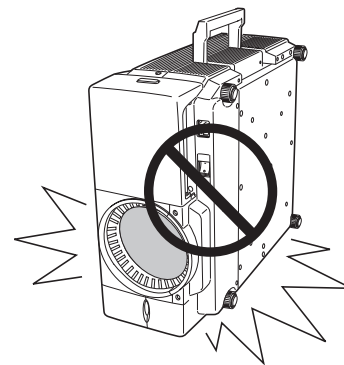

Do not place on an unflat surface and check if no object is under the cabinet.

Caution in Handling the Projector

Do not hold the terminal cover when lifting or moving the projector, or may cause damage to the terminal cover or result in personal injury.

Do not hold the lens when lifting or moving the projector, or may cause damage to the lens and the projector.

Be sure to place the projector on a flat surface and that no object is under the projector. Placing on an uneven surface or any object under the projector may cause damage to the projector's cabinet. Take particular note of the cabinet area around the exhaust vent.

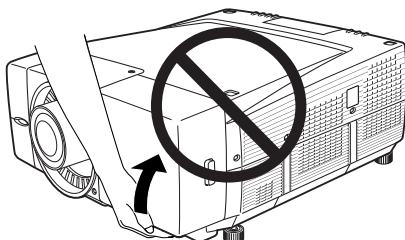

Do not hold the front cover.

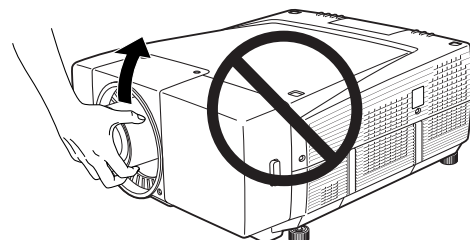

Do not hold the Lens and the peripheral part.

Federal Communication Commission Notice

This equipment has been tested and found to comply with the limits for a Class A digital device, pursuant to Part 15 of FCC Rules. These limits are designed to provide reasonable protection against harmful interference when the equipment is operated in a commercial environment. This equipment generates, uses, and can radiate radio frequency energy and, if not installed and used in accordance with the instruction manual, may cause harmful interference to radio communications. Operation of this equipment in a residential area is likely to cause harmful interference in which case the user will be required to correct the interference at his own expense.

Do not make any changes or modifications to the equipment unless otherwise specified in the instructions. If such changes or modifications should be made, you could be required to stop operation of the equipment.

CAUTION

This is a Class A equipment. This equipment can cause interference in residential areas; in this case, the operator can be asked to take adequate countermeasures.

AC Power Cord Requirement

The AC Power Cord supplied with this projector meets the requirement for use in the country you purchased it.

AC Power Cord for the United States and Canada :

AC Power Cord used in the United States and Canada is listed by the Underwriters Laboratories (UL) and certified by the Canadian Standard Association (CSA).

AC Power Cord has a grounding-type AC line plug. This is a safety feature to be sure that the plug will fit into the power outlet. Do not try to defeat this safety feature. Should you be unable to insert the plug into the outlet, contact your electrician.

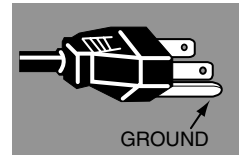

THE SOCKET-OUTLET SHOULD BE INSTALLED NEAR THE EQUIPMENT AND EASILY ACCESSIBLE.

Parts Name

Front

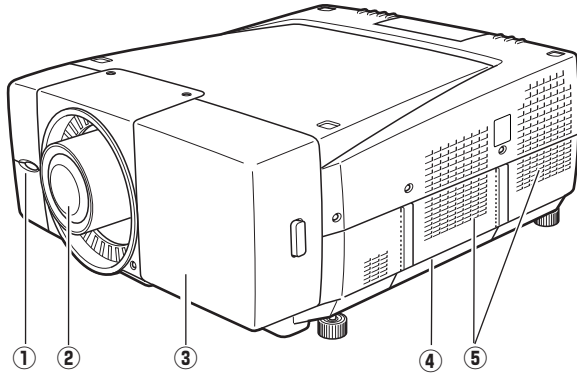

- ① Remote Receiver
- ② Projection Lens (Option)
- ③ Front Cover (inside Terminals)
- ④ Carrying Handle
- ⑤ Air Exhaust Vent



Hot air is exhausted from the exhaust vent. Do not put heat-sensitive objects near this side.

Back

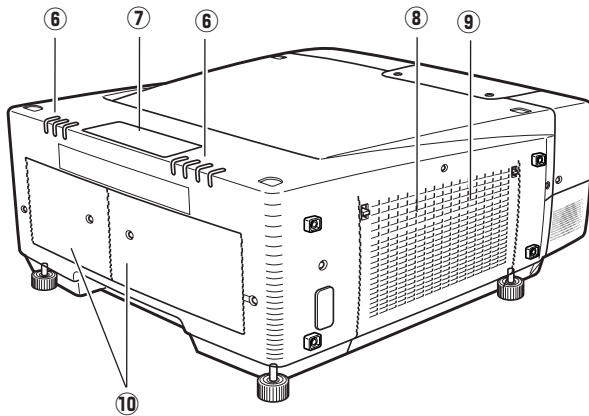

This projector is equipped with cooling fans for protection from overheating. Pay attention to following to ensure proper ventilation and avoid a possible risk of fire and malfunction.

- Do not cover vent slots.
- Keep projector sides clear of any objects. Obstructions may block cooling air.

- ⑥ Indicators
- ⑦ Top Controls
- ⑧ Air Intake Vent
- ⑨ Air Filter (inside)
- ⑩ Lamp Cover

Bottom

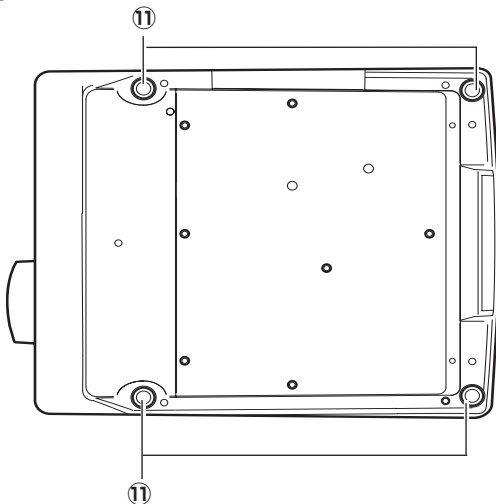

- ⑪ Adjustable Feet

Indicators

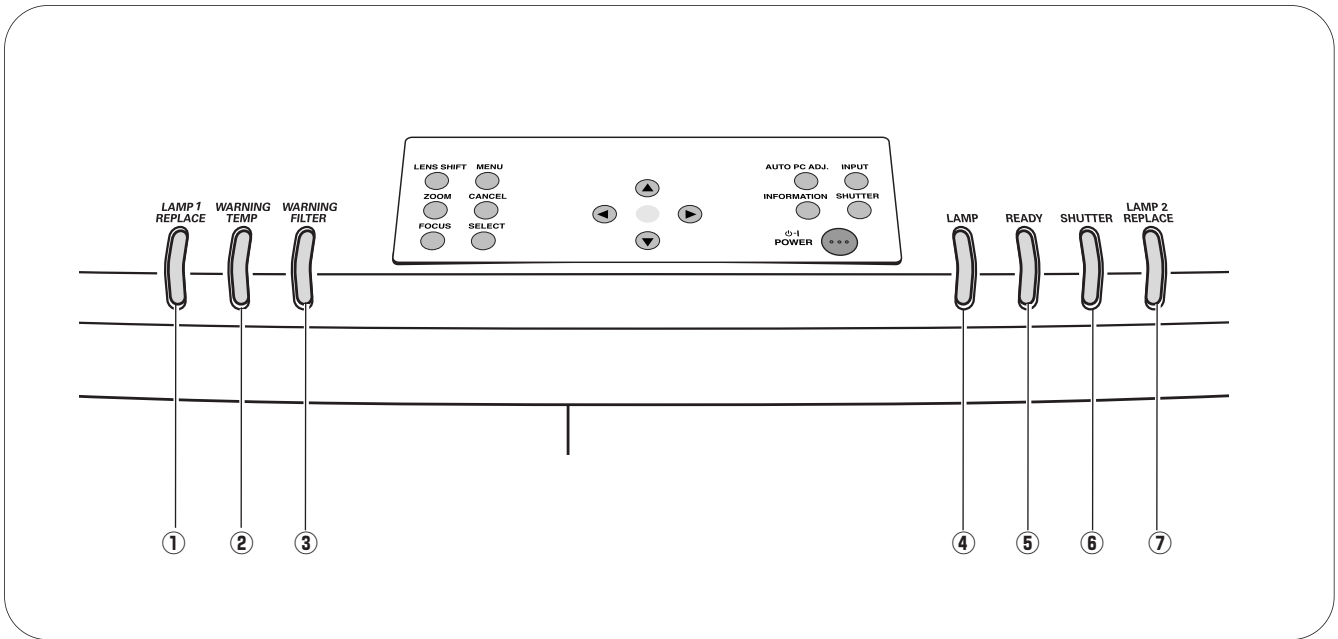

- ① **LAMP 1 REPLACE indicator**
Turns orange when the life of the projection Lamp 1 draws to an end. (p62, 67)
- ② **WARNING TEMP indicator**
Blinks red when the internal temperature of the projector is abnormally high. (p60,65)
- ③ **WARNING FILTER indicator**
Lights orange when the projector's filter is clogged with dust. (p61, 66)
- ④ **LAMP indicator**
 - Lights red when the projector is in the stand-by mode.
 - Turns a dim lighting when the projector is turned on. (p65-67)
- ⑤ **READY indicator**
 - Lights green when the projector is ready to be turned on and remains green lighting during operations.
 - Blinks green in the Power Management mode or when the projector is shutdown due to a power failure. (p65-67)
- ⑥ **SHUTTER indicator**
Lights blue when the shutter is closed. (p66)
- ⑦ **LAMP 2 REPLACE indicator**
Turns orange when the life of the projection Lamp 2 draws to an end. (p62, 67)

Top Control

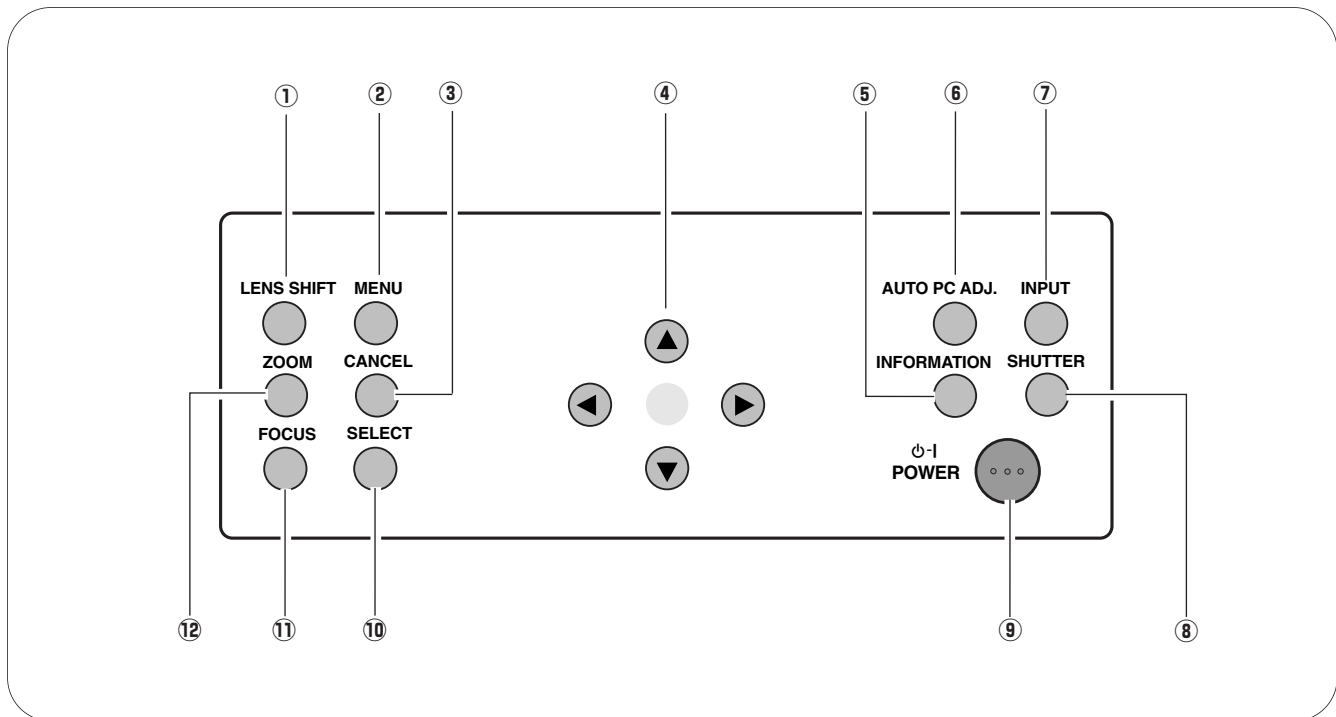

- | | |
|---|--|
| <p>① LENS SHIFT button
Activates the Lens shift function. (p29)</p> <p>② MENU button
Opens or closes the On-Screen Menu. (p33, 34)</p> <p>③ CANCEL button
Cancels the selection and returns to the previous menu.</p> <p>④ Point buttons (▲, ▼, ◀, and ▶)
- Navigate through the menu or adjust the value in the On-Screen Menu. (p33, 34)
- Pan the image in the Digital zoom + mode. (p32)</p> <p>⑤ INFORMATION button
Displays the projector information. (p30)</p> <p>⑥ AUTO PC ADJ. button
Operates the Auto PC adjustment function. (p30)</p> | <p>⑦ INPUT button
Switches input sources. (p30)</p> <p>⑧ SHUTTER button
Closes and opens up the built-in shutter. (p29)</p> <p>⑨ POWER ON-OFF button
Turns the projector on or off. (p27, 28)</p> <p>⑩ SELECT button
- Executes the item selected.
- Expand/compress the image in the Digital zoom +/- mode. (p32, 33)</p> <p>⑪ FOCUS button
Adjusts focus of the image. (p29)</p> <p>⑫ ZOOM button
Adjusts zoom of the image. (p29)</p> |
|---|--|

Terminals

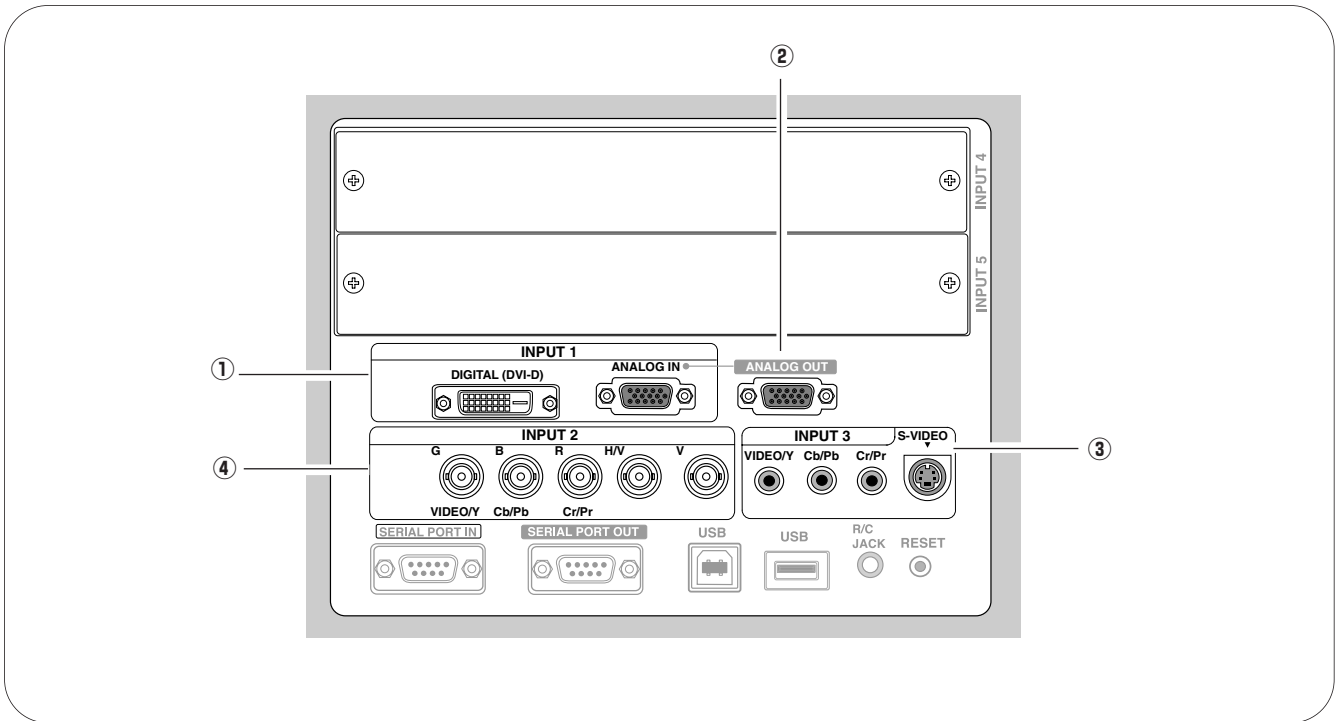

① INPUT 1 terminals

DIGITAL (DVI-D) (HDCP compatible)

Connect digital output signal from a computer or video equipment to this terminal with a DVI-D cable. (p22, 23)

ANALOG IN

Connect analog output signal from a computer or a video equipment (Component or RGB Scart) to this terminal with a VGA cable, a Scart-VGA or a Component-VGA cable. (p22)

② ANALOG OUT

This terminal can be used for analog signal output incoming through the ANALOG IN terminal (INPUT 1). Connect this terminal to the other monitor with a VGA cable. (p22)

③ INPUT 3 terminals

VIDEO/Y, Cb/Pb, and Cr/Pr

Connect video or component output signal (Y, Cb/Pb, and Cr/Pr) from video equipment to these jacks with a video cable (RCA-type). (p23, 24)

S-VIDEO

Connect S-Video output signal from video equipment to this jack. (p23)

④ INPUT 2 terminals

VIDEO/Y, Cb/Pb, and Cr/Pr

Connect video or component output signal (Y, Cb/Pb, and Cr/Pr) from video equipment to these jacks with a video cable (BNC-type). (p24)

G, B, R, H/V, and V

Connect RGB output signal from a computer with a computer cable (5 BNC-type) to these jacks. (p22)

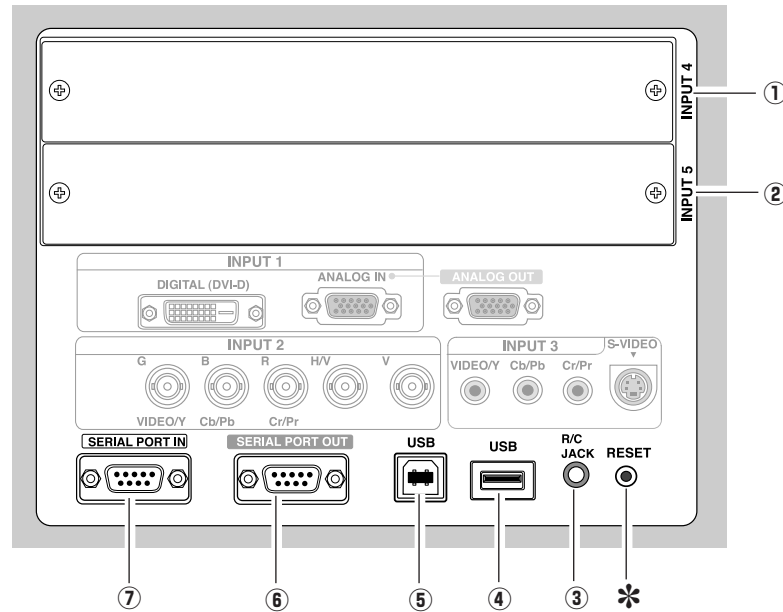

① **INPUT 4 (Vacant for Optional Interface Board)**

Optional interface board can be installed into this slot. (p21, 73)

② **INPUT 5 (Vacant for Optional Interface Board)**

Optional interface board can be installed into this slot. This input accepts digital signals only. (p21, 73)

③ **R/C JACK**

Connect the remote control to this jack with the wired remote cable (not supplied) to use the remote control as wired. (p25)

④ **USB**

Connect a USB mouse (commercially available) to control On-Screen Menu. (p25)

* A built-in micro processor which controls this unit may occasionally malfunction and needs to be reset. This can be done by pressing the RESET button with a pen, which will shut down and restart the unit. Do not use the RESET function excessively.

⑤ **USB (Series B)**

This port is used for the projector maintenance.

⑥ **SERIAL PORT OUT**

This terminal outputs signal from SERIAL PORT IN. When controlling more than two projectors from a computer, connect the other projector to this terminal with a serial cross cable (commercially available).

⑦ **SERIAL PORT IN**

When controlling the projector from a computer, connect the computer to this terminal with a serial cross cable (commercially available).

Remote Control

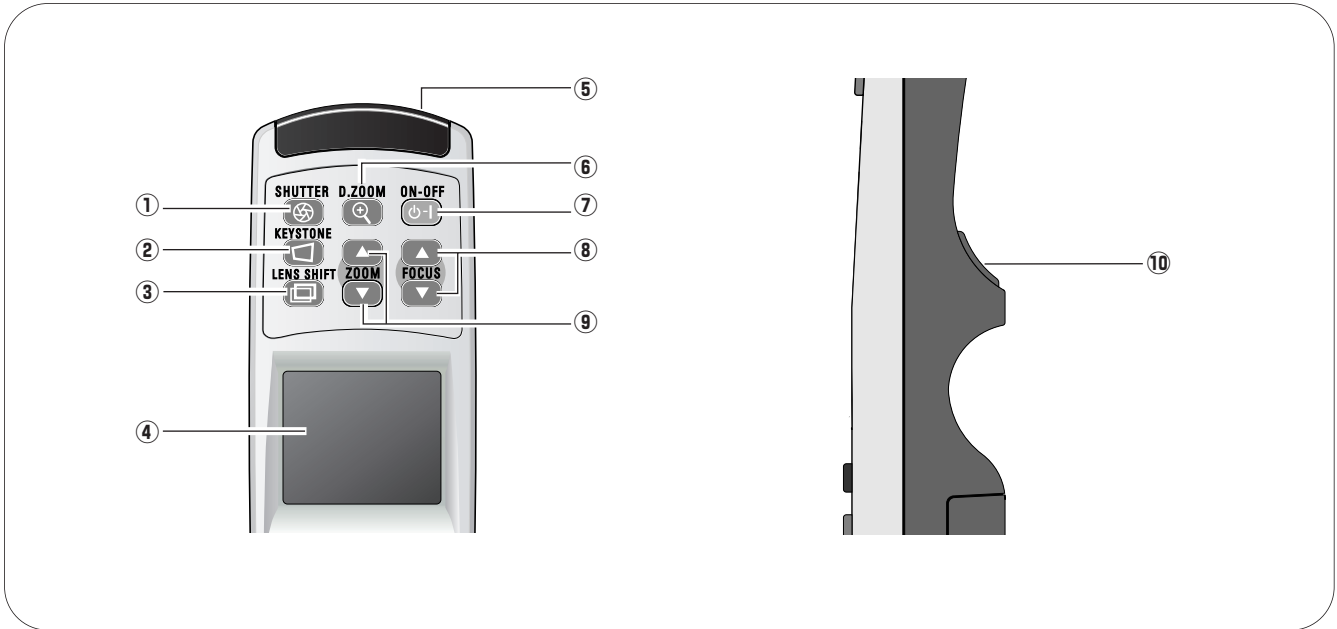

① SHUTTER button

Closes the built-in shutter for light blocking. (p29)

② KEYSTONE button

Corrects keystone distortion. (p31)

③ LENS SHIFT button

Activates the LENS SHIFT function. (p29)

④ CONTROL PAD (semiconductive touchpad)

- Selects an item or adjusts the value in the On-Screen Menu.
- Pan the image in the Digital zoom + mode. (p32)

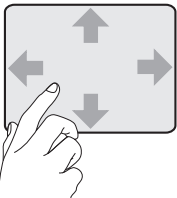

About Control Pad
The built-in Control Pad is a semiconductive touchpad operated with a light finger touch. Move your finger up, down, right and left across the pad to select the desired menu, adjust values and operate various convenient features. Refer to the following pages for respective directions.

⑥ D.ZOOM button

Activates the D.Zoom +/- function. (p32)

⑦ POWER ON-OFF button

Turns the projector on or off. (p27, 28)

⑧ FOCUS buttons

Adjust focus of the image. (p29)

⑨ ZOOM buttons

Adjust zoom of the image. (p29)

⑩ SELECT button

Executes the item selected.

⑤ WIRED REMOTE JACK

Connect the Wired Remote Cable (not provided) to this jack.
Battery installation is required regardless of it is used as wired or wireless. (p16, 25)

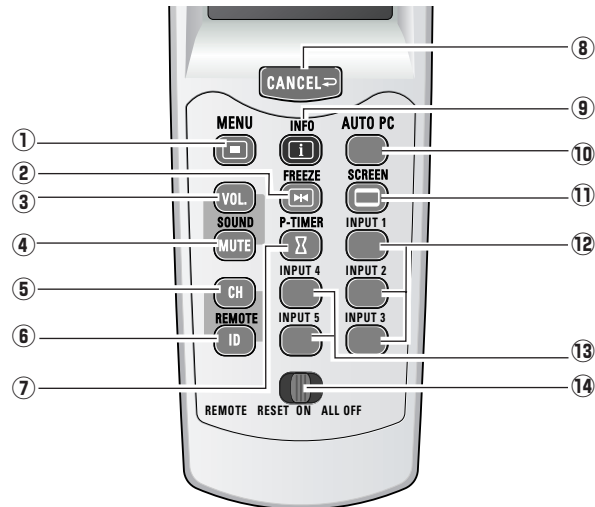

① **MENU button**
Opens or closes the On-Screen Menu. (p33, 34)

② **FREEZE button**
Freezes the projected picture. (p31)

③ and ④ buttons are unusable.

⑤ **CH button**
Switches Remote Control Channel (CH). (p16)

⑥ **ID button**
Switches Remote Control ID. (p16)

⑦ **P-TIMER button**
Operates P-Timer function. (p31)

⑧ **CANCEL button**
Cancels the selection and returns to the previous menu. (p33)

⑨ **INFO button**
Displays the projector information. (p30)

⑩ **AUTO PC button**
Operates the Auto PC adjustment. (p30)

⑪ **SCREEN button**
Selects screen sizes. (p31)

⑫ **INPUT 1-3 buttons**
Selects input source (INPUT 1 - INPUT 3). (p30)

⑬ **INPUT 4-5 buttons**
Selects input source (INPUT 4 - INPUT 5). (p30)

⑭ **REMOTE RESET/ON/ALL-OFF switch**
When using the remote control, set this switch to "ON."
Set it to "ALL OFF" for power saving when it is not used. Slide this switch to "RESET" by holding down the CH and ID buttons at the same time to initialize the Remote Control ID and CH. (p16)

Remote Control Transmitter

This wireless remote control uses radio frequency signal. You can switch four frequency channels prepared and select a remote control ID from eight IDs. The Remote Control Channel selection prevents radio frequency interference from the other equipment and the Remote Control ID selection allows you to operate several projectors with their respective remote controls without mutual interference among those projectors.

Wired Remote Control Transmitter

The remote control can be used as a wired remote control. When interference between the projector and other equipment occurs or the projector is used in a place where the operation of radio equipment is restricted, connecting the remote control and the projector with the wired remote cable (POA-CA-RC30) separately supplied is recommended. (p73) Connected with the wired remote cable, the remote control does not emit radio signal.

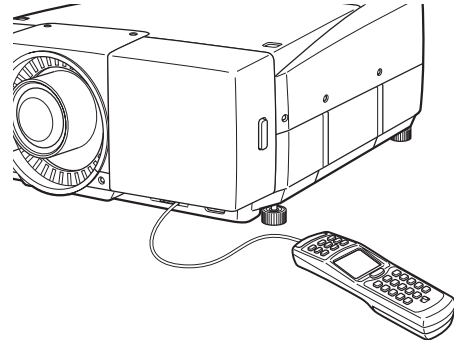

Remote Control Channel and ID Setup

Initial Remote Control Channel and ID are CH1 and ID1. When you change the setting, set a Channel first, and then an ID.

Channel and ID settings for the remote control should be the same as those for the projector. When changing the CH and ID settings to the remote control, do it to the projector as well. Refer to "Remote Control" in Setting menu on page 51.

Should you be lost at which CH and ID are currently set, initialize the Channel and ID once, and set them again.

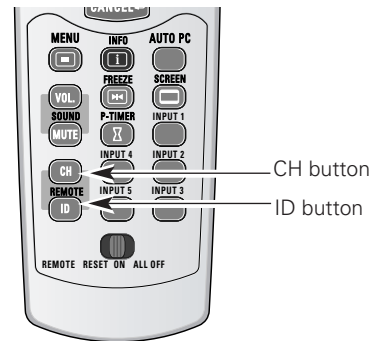

1 Set the Remote Control Channel

Hold down the CH button and press the SELECT button. The Remote Control Channel switches sequentially for one pressing the SELECT button. (See Table1 on next page.)

2 Set the Remote Control ID

Hold down the ID button and press the SELECT button. The Remote Control ID switches sequentially for one pressing the SELECT button. (See Table2 on next page.)

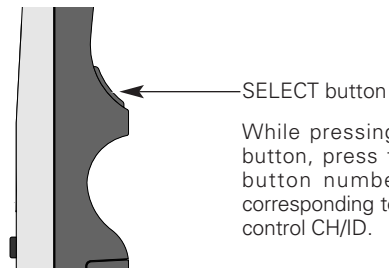

Initialize the Remote Control Channel and ID

Press and hold the CH and ID buttons, and slide the REMOTE RESET/ON/ALL-OFF switch to REMOTE RESET, and then to ON. The initial Channel and ID are CH1 and ID1. (p15)

✓ **Note:**
Remote Control Channel and ID cannot be initialized separately.

Remote Control CH	Radio Frequency
CH 1 *	2.472 GHz
CH 2	2.403 GHz
CH 3	2.446 GHz
CH 4	2.421GHz

Channel switches sequentially for one pressing the SELECT button.



Table1: Remote Control Channel & Frequency

* Default setting

Remote Control ID
ID 1 *
ID 2
ID 3
ID 4
ID 5
ID 6
ID 7
ID 8

ID switches sequentially for one pressing the SELECT button.



Table2: Remote Control ID



Caution about Radio Wave

The remote control operates in 2.4 GHz band, the same frequency band used for industrial, scientific, and medical equipment (such as pacemaker), as well as amateur radio stations.

Before operating the remote control, make sure no electromagnetic interference occurs and pay attention to the following cautions.

1. Be sure that there are no other devices in the area that may use the same frequency band as the remote control.
2. If any other devices are causing radio interferences, change the communication frequency channel or move to other location.

Caution in Wireless LAN Interference

Under wireless LAN environment based on IEEE 802.11b and IEEE802.11g, the remote control may not operate properly due to radio interferences. The remote control is initially set to use 2.472 GHz band (CH1) corresponding to several channels of wireless LAN.

Should the remote control not operate properly due to radio interference, switch the communication frequency channel to CH2. Yet the operating condition is not improved, try CH3 and CH4. In case of failure in every channel operation, relocate other radio equipment using 2.4 GHz band away from the remote control and the projector.

Remote Control Battery Installation

- 1 Open the battery compartment lid.

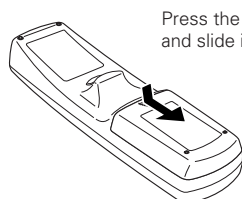

Press the lid downward and slide it.

- 2 Install new batteries into the compartment.

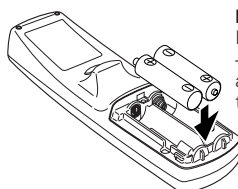

Two AA size alkaline batteries
For correct polarity (+ and -), be sure battery terminals are in contact with pins in the compartment.

- 3 Replace the compartment lid.

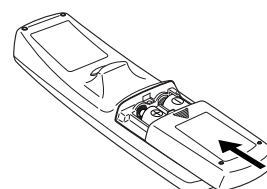

To insure safe operation, please observe the following precautions:

- Use (2) AA or LR6 type alkaline batteries.
- Always replace the batteries in sets.
- Do not use a new battery with a used battery.
- Avoid contact with water or liquid.
- Do not expose the remote control to moisture, or heat.
- Do not drop the remote control.
- If a battery has leaked on remote control, carefully wipe case clean and install new batteries.
- Risk of explosion if battery is replaced by an incorrect type.
- Dispose of used batteries according to the instructions.

Installation

Installation

Install the projector in a safe place. Before installation, read Safety Instructions thoroughly and check the installation place. Install the projector in a place with sufficient strength to support the projector's weight. Installation on an unstable stand, cart, or ceiling may cause serious injury or accidents.

Do not place the projector where is extremely hot and humid. Do not place the projector where is dusty and smoky. When installing the projector in dusty and smoky places or in a place for a long period of time, installation with Smoke Resist Box (AH-69601) separately supplied is recommended. (p73)

Lens Installation

Before setting up the projector, install optional lens in the projector. Install the lens following the instructions in the Lens Installation Manual provided. Ask the sales dealer for detailed information of optional lens specifications.

Do not move the projector with holding the lens mounted and its peripheral part. It may cause serious damages to the projector and the lens.



When moving or setting up the projector, check the followings again:

- Be sure that the lens is securely installed into the projector.
- Be sure to replace Lens cap to protect lens surface.
- Be careful not to hold or subject a lens to strong forces. It may damage lens, cabinet, or mechanical parts.

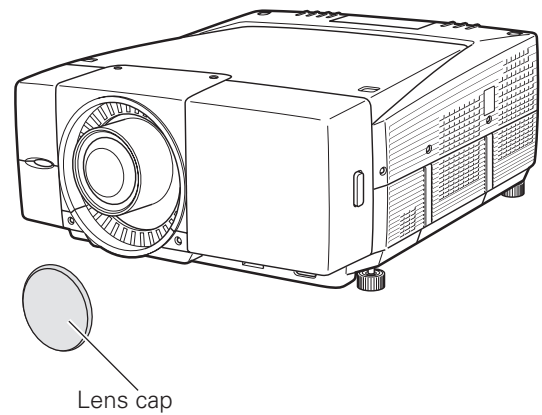

Positioning the Projector

This projector is designed to project on a flat surface. Projector should be perpendicular to the projection screen. Otherwise, the projected image may be distorted. Keystone function allows you to correct image distortions, but it should be considered that the keystone correction may lower the image resolution. (p31)

Do not expose the projection screen to direct sunlight or excessive ambient lighting. The projected image may get white-tinged due to reflection and the best image quality may not be obtained.

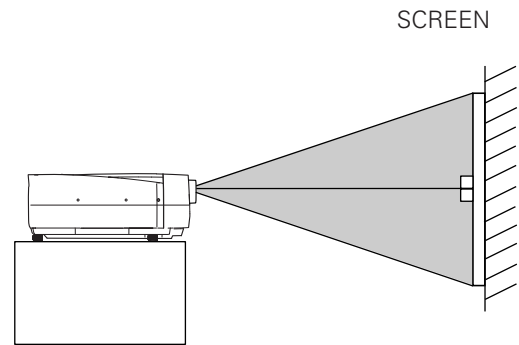

Lens Shift Adjustment

Lens shift feature is provided to move the position of the projected image vertically by 50% and horizontally by 10% respectively without any image distortion.

* Lens shift range varies depending on lens and projectors. The range in this manual is the case of LNS-W04.

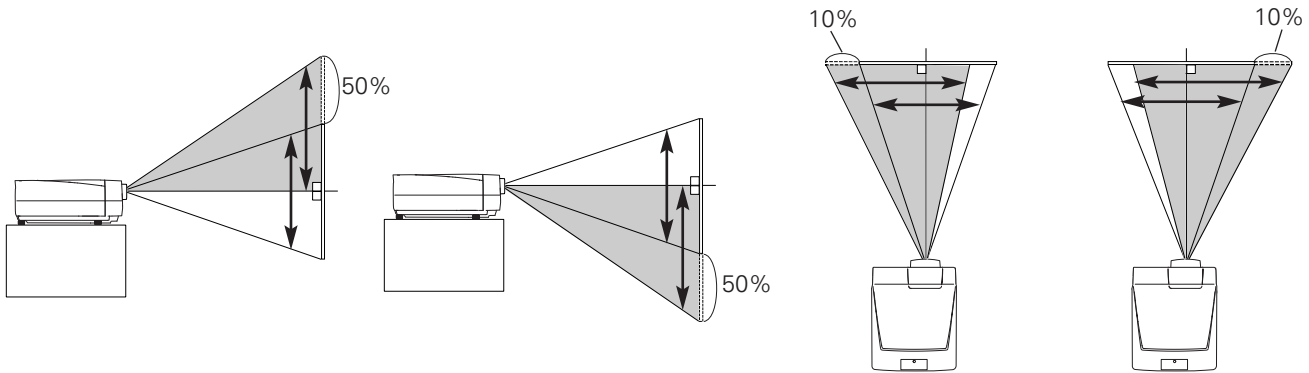

Level Adjustable Feet

This projector has four level adjustable feet. The projection angle can be adjusted by rotating each foot. Adjust the four feet to obtain best position of the projected image and make the projector stable.

The projection angle is adjustable up to 3.65 degrees upward and downward respectively by rotating front and back feet.

The projector can project image vertically and horizontally in the range of 360 degrees. For proper installation, refer to Setup In Proper Directions on page 6.

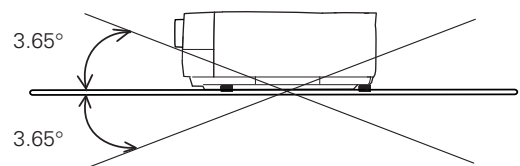
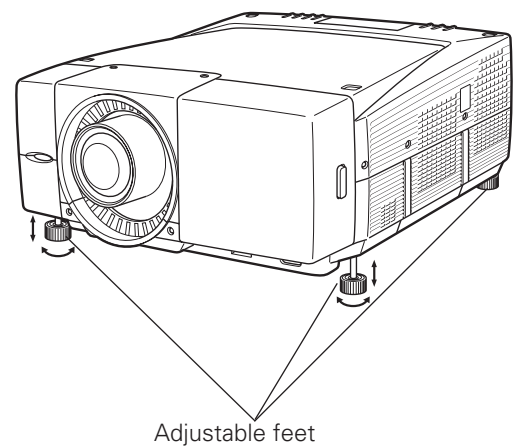

Projection angle is adjustable up to 3.65 degrees upward and 3.65 degrees downward by adjusting front and back feet.

Connecting AC Power Cord

This projector uses nominal input voltages of 120 V or 200-240 V AC. This projector automatically selects correct input voltage. It is designed to work with single-phase power systems having a grounded neutral conductor. To reduce risk of electrical shock, do not plug into any other type of power system. Consult your authorized dealer or service station if you are not sure of type of the power being supplied. Connect the projector with all peripheral equipment before turning it on. (Refer to pages 22 ~ 24 for connection.)

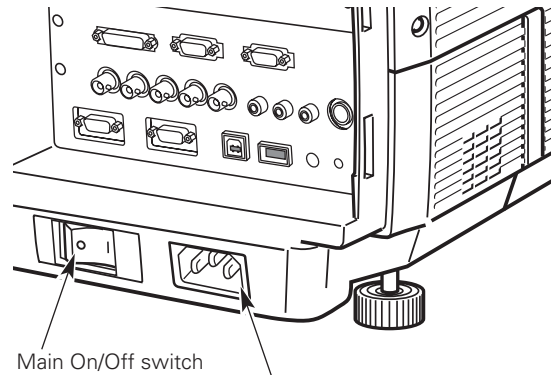

CAUTION

For safety, unplug the AC power cord when the projector is not in use. When this projector is connected to an outlet with the AC power cord and the Main On/Off switch is on, it is in stand-by mode and consumes a little electric power.

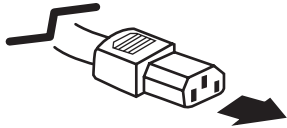
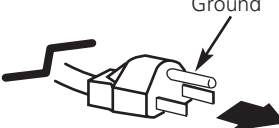
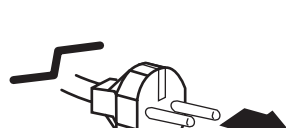
NOTE ON THE POWER CORD		
<p>The AC Power Cord must meet the requirement of the country where you use the projector. Confirm the AC plug type with the chart below. The proper AC Power Cord must be used. If the supplied AC Power Cord does not match the AC outlet, contact your sales dealer.</p>		
Projector side	AC Outlet side	
 <p>To the POWER CORD CONNECTOR on the projector.</p>	<p>For the U.S.A. and Canada</p>  <p>To the AC Outlet. (120 V AC)</p>	<p>For Continental Europe</p>  <p>To the AC Outlet. (200 - 240 V AC)</p>

Connection Terminals

Terminals for connecting the AC power cord and other equipment are located in the front part of the projector for easy setup. The terminal area is covered with a front cover to protect from dust and others, and hide messy cable connections.

Remove and replace the front cover by following the procedure below:

To remove the front cover, push the button **A** on right side of the front cover and pull the cover forward.

To put back the front cover to the projector, insert the left part of the cover into the projector and then push the entire cover. Make sure that the front cover is locked with the button **A** and fitted on the projector.

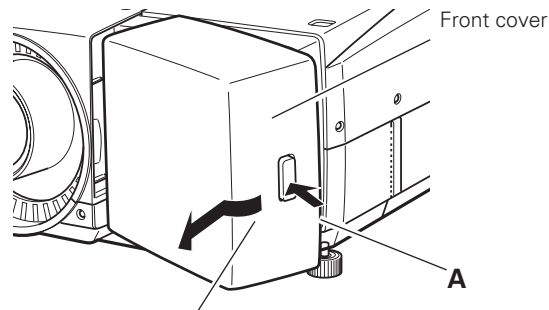

Pull this part forward by pushing button **A**.

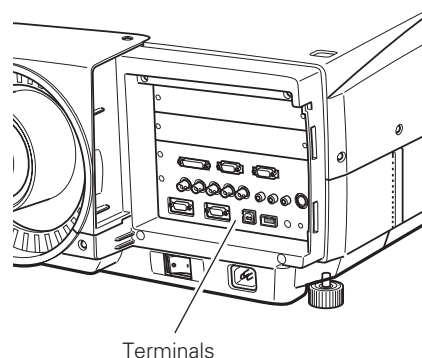

Caution

Do not push the front cover hard or subject it to excessive shock. Doing so may damage the cover.

Interface Board Slots

The projector's front terminal area has two replaceable Interface board slots. The projector's functions can be extended by installing the optional interface boards into the terminal slots. Two vacant slots (Input 4 and Input 5) are provided in your purchasing the projector.

Install or replace the optional interface boards as follows:

Remove two (2) screws and uncover the slot.

Insert an interface board into the slot along with the guides inside to fit the socket into the inside plug. Secure the board with the two (2) screws.

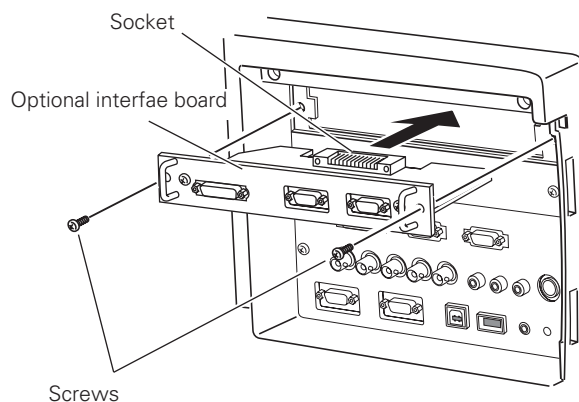

✓ Note:

When installing or removing the interface board, disconnect the AC power cord from the AC outlet before doing it.

✓ Notes On Ordering or Using Optional Interface Boards:

When ordering or using the Optional Interface Boards, contact your sales dealer and tell the Model no. of your desired board (p73) and Option Control No. shown in the Information menu. (p30 and 59)

Option Control No.

Shutter management	On
Smoke resist	
Option filter time	
Security	Key lock
	PJ lock
	USB lock
Remote control	CH-1
Option Control No. 06	

See Option Control No. in the Information menu to order any optional interface board.

Connecting to Computer (Digital and Analog RGB)

Cables used for connection

- ① VGA Cable (HDB 15 pin) Only one cable is supplied.
 - ② DVI-D Cable *
 - ③ BNC Cable *
 - ④ Serial Cross Cable (RS-232C) *
- (* = Not supplied with this projector.)

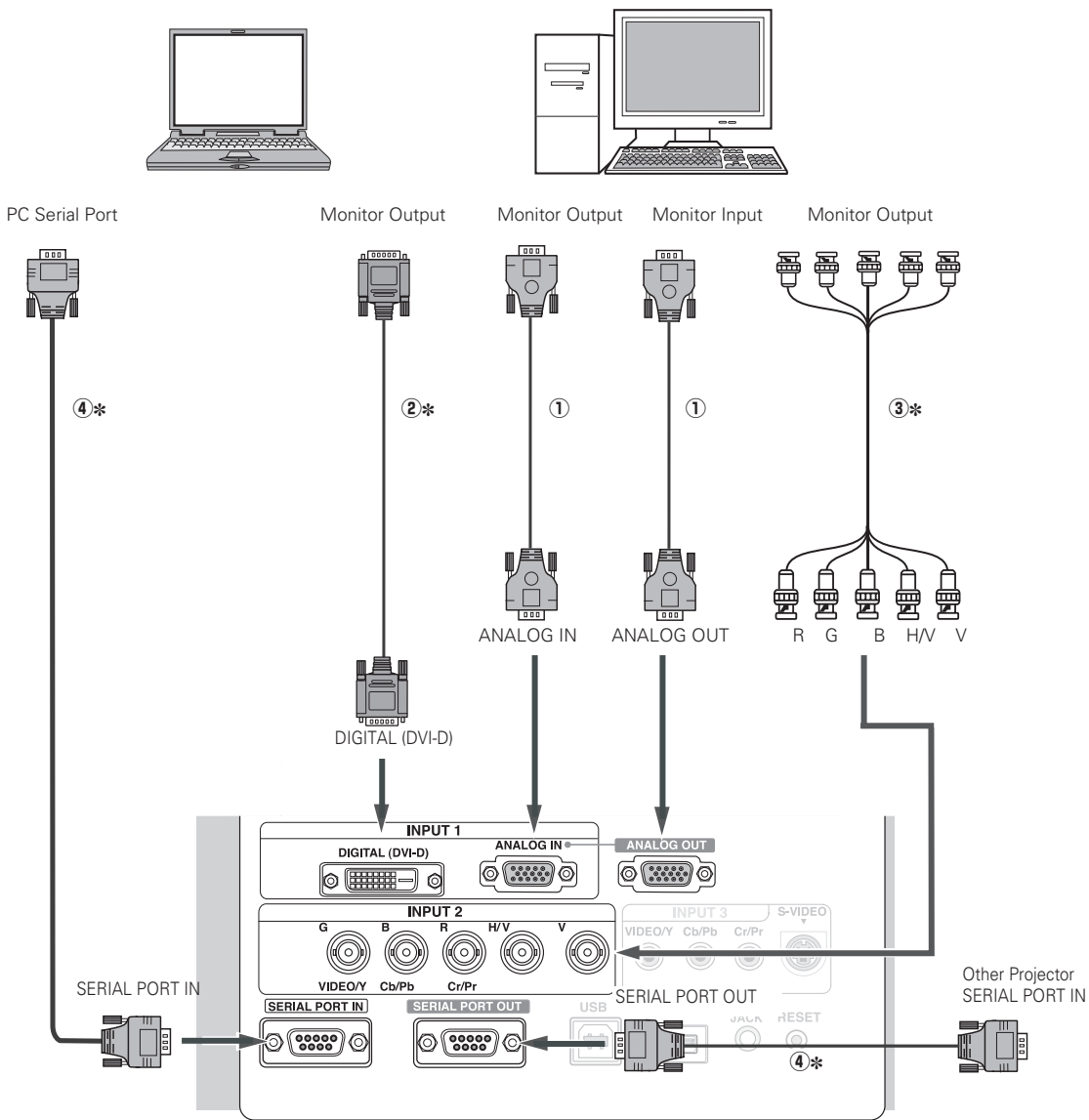

Note:
Unplug the power cords of both the projector and external equipment from the AC outlet before connecting the cables.

Connecting to Video Equipment (Digital and Video)

Cables used for connection

- ① Video Cable *
- ② S-Video Cable *
- ③ DVI-D Cable *

(* = Not supplied with this projector.)

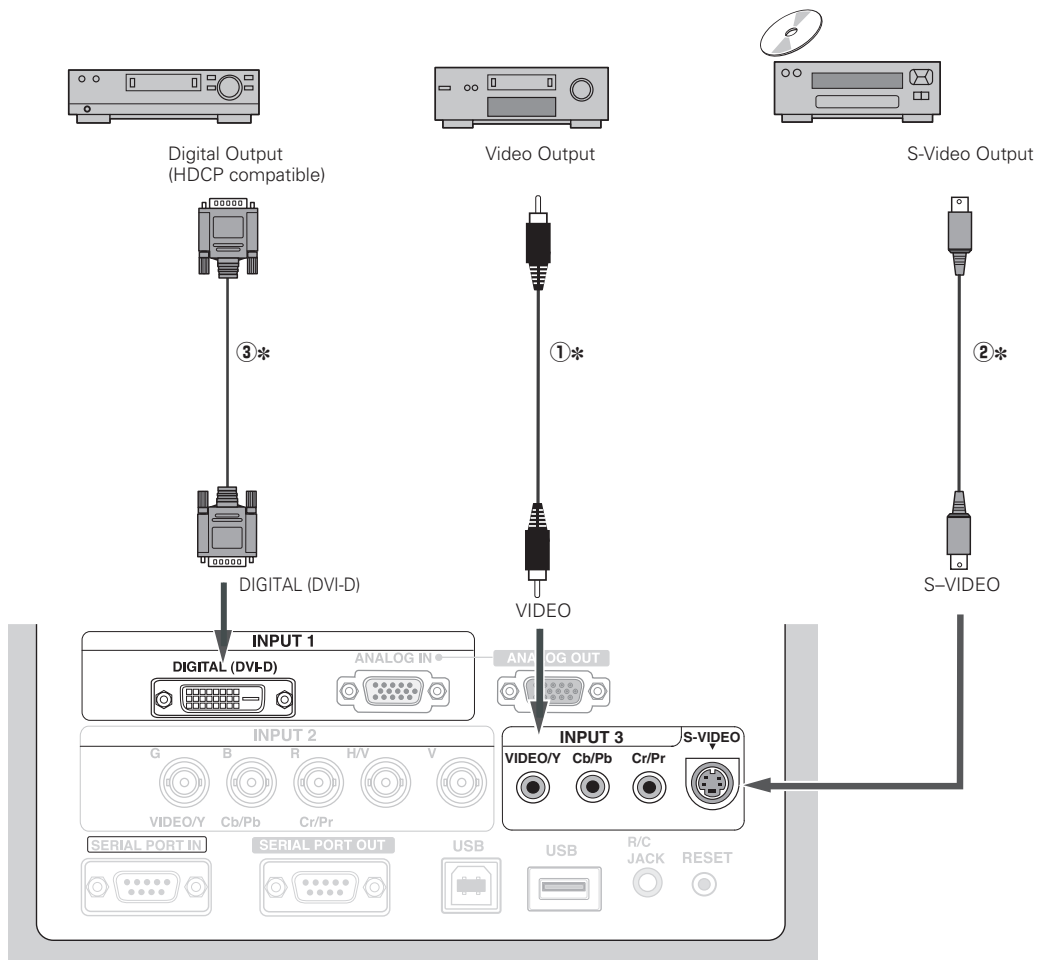

Note:

Unplug the power cords of both the projector and external equipment from the AC outlet before connecting the cables.

Connecting to Video Equipment (Component and RGB Scart)

Cables used for connection

- ① BNC Cable *
- ② Scart-VGA Cable *
- ③ Component Cable *

(* = Not supplied with this projector.)

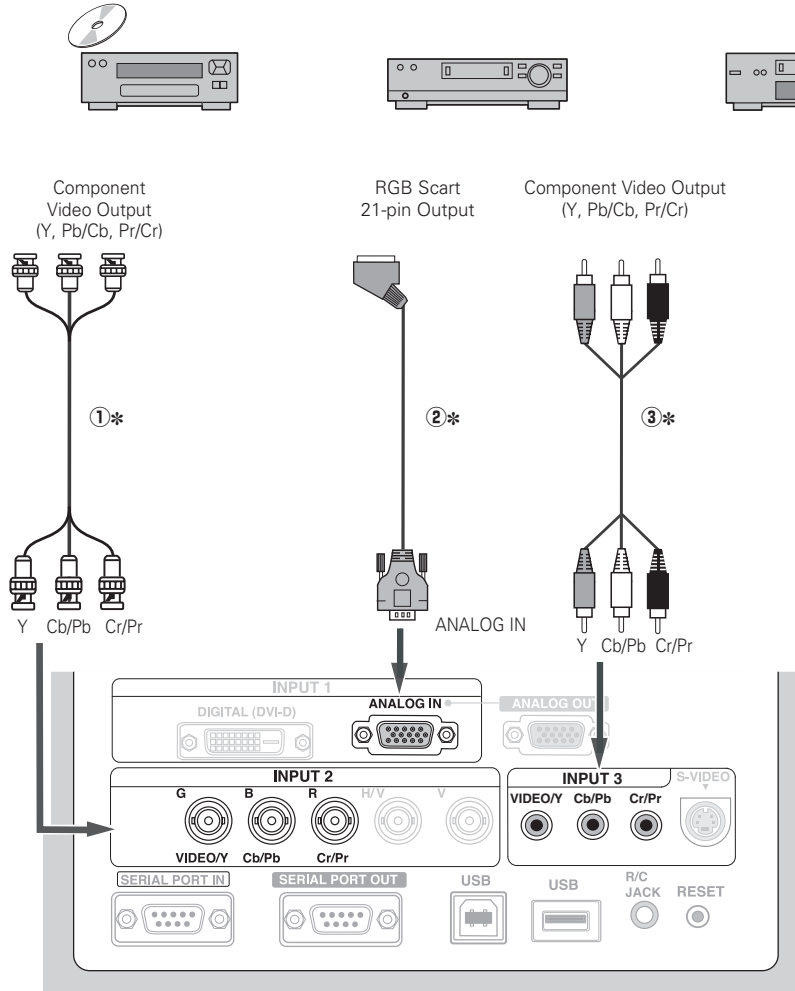

Note:
Unplug the power cords of both the projector and external equipment from the AC outlet before connecting the cables.

Basic Operation

Operating the Projector

You can operate the projector with the projector's top control, the remote control or a USB mouse (not provided). The remote control can be used wireless or wired.

Operational range of the wireless remote control is within about 32.8' (10m) from the projector. Operational range differs depending on environments where the projector is used. Any obstruction to air signal between the projector and the remote control may prevent the remote control from working properly.

Wireless Remote Control Operation

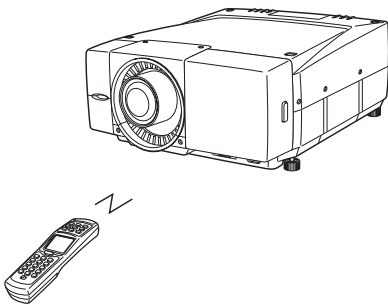

The wireless remote control does not work when the wired remote cable is connected to either the projector or the remote control. Remove the wired remote cable from both of the projector and the remote control when using it as wireless.

Wired Remote Control Operation

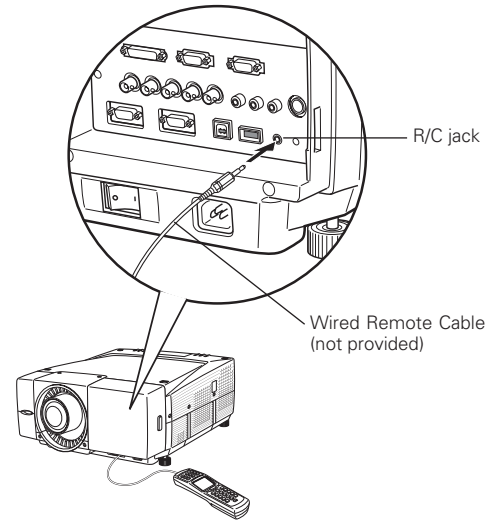

Connect the R/C JACK on the projector and the remote control with the wired remote cable when operating the remote control as wired.

Mouse Operation

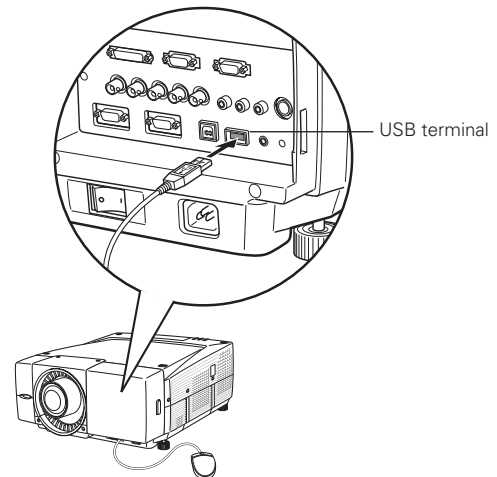

Connect the USB terminal on the projector and a USB mouse when operating the projector's menu with the USB mouse. A mouse cursor appears on the screen with the mouse connected. Mouse operation offers the On-Screen Menu control only. Other operations are unavailable with the USB mouse. For details of the mouse operation, refer to pages 33~34.

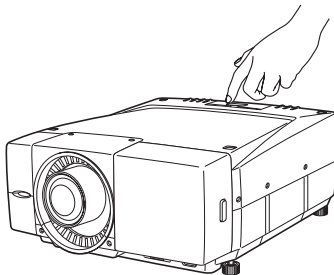

Projector Top Control Operation



Basic Operation

Basic Operation and Reference Buttons

For detail operations other than those on this page, follow the respective menu operations described later.

Operations & Buttons	<p style="text-align: center;">Top Control</p> 	<p style="text-align: center;">Remote Control</p> 	Ref. Pages
On-Off	○	○	27, 28
Lens Shift	○ → Point buttons	○ → Pad	29
Zoom	○ → Point buttons	○ (▲▼)	29
Focus	○ → Point buttons	○ (▲▼)	29
Shutter	○	○	29, 53
Auto PC Adjust	○	○	30, 40
Input Selection	○	○ (Input 1-5)	30, 36~37
Information	○	○	30, 59
Keystone	-	○ → Pad	31, 48
Screen Selection	-	○	31, 47
Freeze	-	○	31
P-Timer	-	○	31
D. Zoom	-	○ → Pad	32, 48
Remote CH and ID	-	○	16, 17
Menu	○	○	33~35
Select	○ + Point buttons	○ → Pad	
Cancel	○	○	
	<i>These buttons are used on the menu operations.</i>	<i>These buttons are used on the menu operations.</i>	

Turning On the Projector

- 1 Complete peripheral connections (with Computer, VCR, etc.) before turning on the projector. (Refer to pages 22~24 for connection.)
- 2 Turn on the MAIN On/Off switch of the projector. The LAMP indicator lights red, and the READY indicator lights green.
- 3 Press the POWER ON-OFF button on the top control or the remote control. The LAMP indicator dims, and the cooling fans start to operate. The preparation display appears on the screen and count-down starts. The input and source selected last appears after 20 seconds count-down.

If the projector is locked with a PJ PIN code, PJ PIN code Input Dialog Box will appear. Enter the PIN code as instructed below.



The preparation display disappears after 20 seconds.

Selected Input and Source

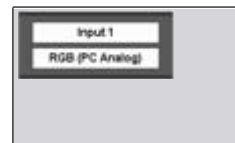

(See pages 36~37 for Input)

Enter a PJ PIN code

Select a number by using the Point buttons (▲, ▼, ◀, and ▶) or Control pad and fix the number with the SELECT button. The number will change to “*”. If you fixed a wrong number, move the yellow frame pointer to “C” or “Ent” once, then enter the correct number. Repeat this step to complete entering a four-digit number.

When the four-digit number is fixed, move the yellow frame pointer to “Ent”. Press the SELECT button so that you can start to operate the projector.

If you entered a wrong PIN code, the entered number (****) will turn red and disappear. Enter a correct PIN code all over again.

What is PIN code?

PIN Personal Identification Number code is a security code that allows the person who knows it to operate the projector. Setting a PIN code prevents the projector from being operated by an unauthorized person.

A PIN code consists of a four-digit number. Refer to Security in Setting on page 55 for locking operation of the projector with your PIN code.



CAUTION ON HANDLING PIN CODE

If you forget your PIN code, the projector can no longer be started. Set a new PIN code with special care, write it down in column on page 79 of this manual, and keep it at hand. Should the PIN code be missing or forgotten, consult your sales dealer or the service station.

PJ PIN code Input Dialog Box



Pointer (yellow frame)



After the OK icon disappears, you can operate the projector.

Turning Off the Projector

- 1 Press the POWER ON-OFF button on the top control or the remote control, and a message "Power off?" appears on the screen.
- 2 Press the POWER ON-OFF button again to turn off the projector. The LAMP indicator brightly lights red and the READY indicator goes out. After approximately 90 seconds, the READY indicator will light green again and then the projector can be turned on by pressing the POWER ON-OFF button.
- 3 The Cooling fans operate for approximately 2 minutes after the projector is turned off; keep operating more 30 seconds after the READY indicator lights green. To power down the projector completely, turn off the MAIN On/Off switch and disconnect the AC Power Cord.



TO MAINTAIN THE LIFE OF LAMP, ONCE YOU TURN PROJECTOR ON, WAIT AT LEAST 5 MINUTES BEFORE TURNING IT OFF.

DO NOT DISCONNECT AC POWER CORD WHILE COOLING FANS ARE RUNNING OR BEFORE POWER INDICATOR LIGHTS RED. OTHERWISE IT WILL RESULT IN SHORTENING LAMP LIFE.

✓ **Note:**

- The projector cannot be turned on for about 90 seconds after turned off. You can turn it on again after the READY indicator lights green.
- When the On start function is on, this projector is turned on automatically by connecting the AC power cord to an AC outlet. (See page 52 for the On start function.)
- Do not operate the projector continuously without rest. Continuous use may result in shortening the lamp life. Turn off the projector and give it a rest about an hour in every 24 hours.
- This projector monitors internal temperature and automatically controls the running speed of the cooling fans.
- If the WARNING TEMP indicator blinks red or all the indicators except the LAMP indicator are blinking, see "Warning Temp Indicator" on page 60.
- When "Power management" mode is Ready or Shut down, projector detects signal interruption and turns off the Projection Lamp automatically after the set time has passed. Refer to "Power management" on page 52.

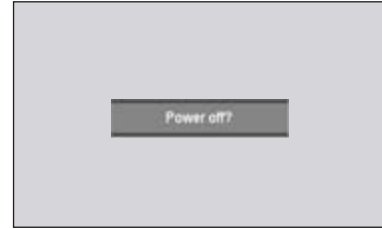

The message disappears after 4 seconds.

Lens Shift Adjustment

Press the LENS SHIFT button and adjust the lens position with the Point buttons (▲, ▼, ◀, and ▶) or with the Control pad.

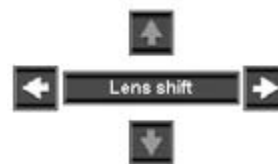

- When the lens position comes right in center vertically, the vertical arrows turn red.
- When the lens position comes right in center horizontally, the horizontal arrows turn red.

Zoom and Focus Adjustment

Top Control

Press the ZOOM/FOCUS button and adjust with the Point buttons (▲ and ▼).

Remote Control

Press the ZOOM/FOCUS ▲▼ buttons to adjust Zoom and Focus.



Shutter Function

Shutter function allows you to completely block out light to the screen. Press the SHUTTER button to close the shutter inside the projector. To open up the shutter, press the SHUTTER button again. Refer to pages 53~54 for detail of setting for the Shutter function.

Remote Control

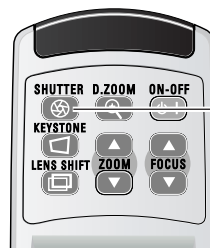

SHUTTER button

✓ Note:

- The SHUTTER buttons on the top control and the remote control can not be effective when Shutter Protection is "On" in the Setting menu. (p53)
- The SHUTTER indicator on the projector's top lights blue when the shutter is closed. (p10)
- When the Shutter level is "High contrast" in the Setting menu, the shutter opens up 80%. (p53)
- The projector will shut down automatically when the set time on Shutter management has passed. (p54)

Top Control

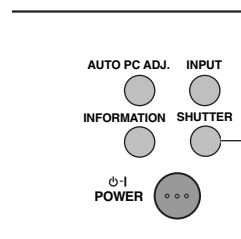

SHUTTER button

Input Selection

Choose either Input 1, Input 2, Input 3, Input 4, or Input 5 by pressing the INPUT button on the top control or the INPUT 1, INPUT 2, INPUT 3, INPUT 4, or INPUT 5 buttons on the remote control.

Before using these buttons, correct input source should be selected through menu operation as described on pages 36~37.

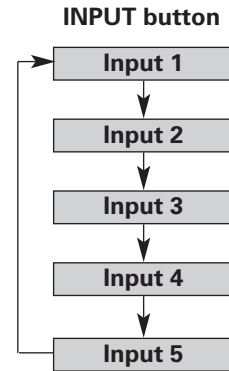

✓ Note:

Input 4 and Input 5 can not be selected when no interface board is inserted into the respective slots. (p21)

Auto PC Adjustment

Auto PC Adjustment function is provided to automatically adjust Fine sync, Total dots, Horizontal, and Vertical picture position to conform to your computer by just pressing the AUTO PC ADJ. on the top control or on the remote control.

✓ Note:

- Fine sync, Total dots, and Picture Position of some computers can not be fully adjusted with this Auto PC Adjustment function. When the image is not provided properly with this operation, manual adjustments are required. (p41, 42)
- Auto PC Adjustment function cannot be operated in Digital Signal input on DVI terminal and 480i, 575i, 480p, 575p, 720p (HDTV), 1035i (HDTV), 1080i/50 (HDTV), or 1080i/60 (HDTV) is selected on System menu (P39).

Information

Information display can be used to confirm the current operating condition of the projector and the signal being projected through the projector.

Press the INFORMATION button on the top control or the INFO button on the remote control to display Information window on the screen. To hide the Information window, press the INFORMATION/INFO button again.

Use this menu to check the projector's operating condition when you face troubles in operation. Refer to the Information menu on page 59.

Input	Input 1
	RGB (PC Analog)
System	VGA 1
Signal	Yes
Screen	Normal
Language	English
Lamp mode	2- Lamp
Lamp status	Lamp 1 On
	Lamp 2 On
Power management	Off
Shutter management	On 180 Min.
Smoke resist	Yes
Option filter time	0 Hour(s)
Security	Key lock Off
	PJ lock Off
	USB lock Off
Remote control	CH-1 ID-1
Option Control No. 06	Quit

Keystone Adjustment

Keystone function is provided to correct image distortions. Press the KEYSTONE button on the remote control and correct vertical and horizontal distortions with the Point buttons (▲, ▼, ◀, and ▶) or the Control pad. The Keystone adjustment can be memorized. (p48)

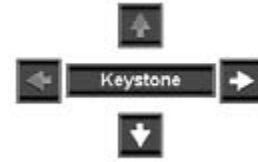

✓ **Note:**

Horizontal keystone is ineffective for LC-SX6A.

- The arrows are white when there is no correction.
- The arrows disappear at the maximum correction.
- The direction of the arrow being corrected turns red.
- If you press the KEYSTONE button on the remote control once again while the keystone dialog box is being displayed, the keystone adjustment will be canceled.

Screen Selection

Select a screen size among Normal, Wide, True, Full screen, and Custom by pressing the SCREEN button on the remote control. Refer to the Screen menu on page 47 for details of each screen setting.

✓ **Note:**

True cannot be selected when selecting AV sources for the Input.

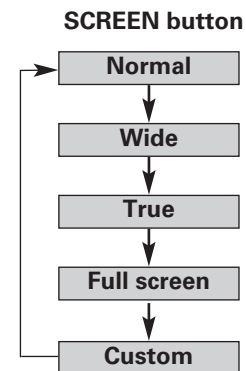

Picture Freeze Function

Press the FREEZE button on the remote control to freeze the picture on screen. To cancel the Freeze function, press the FREEZE button again or press any other button.

P-Timer Function

Press the P-TIMER button on the remote control. The timer display "00 : 00" appears on the screen and the timer starts to count time (00 : 00 ~ 59 : 59).

To stop the counting, press the P-TIMER button. And then, press the P-TIMER button again to cancel the P-Timer function.



D. Zoom +/- Function

D. Zoom +

Press the D. ZOOM button on the remote control once and then expand the image size with the SELECT button and pan the image with the Point buttons (▲, ▼, ◀, and ▶) or the Control pad.

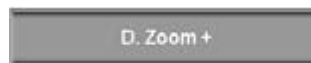

D. Zoom -

Press the D. ZOOM button on the remote control twice and then compress the image size with the SELECT button.

✓ Note:

To exit the D. Zoom +/- mode, try the followings:

- To return to the normal screen, change Input, or change the screen size.
- To exit the panning mode, press any button except the D. ZOOM button, the SELECT button, and the CH and ID buttons.

How to Operate On-Screen Menu

The projector can be adjusted or set via the On-Screen Menu. Refer to the following pages for respective adjustment and setting procedure.

Top Control Operation

- 1** Press the MENU button on the projector's top control to display the On-Screen Menu.
- 2** Press the Point buttons (◀ and ▶) on the top control to spin Menu icons. When the desired Menu icon comes right in front, press the SELECT button to display the submenu.
- 3** Move the pointer or adjust the value of item by pressing the Point buttons (▲, ▼, ◀, and ▶) on the top control.
- 4** Select an item or set the selected function by pressing the SELECT button.

Top Control

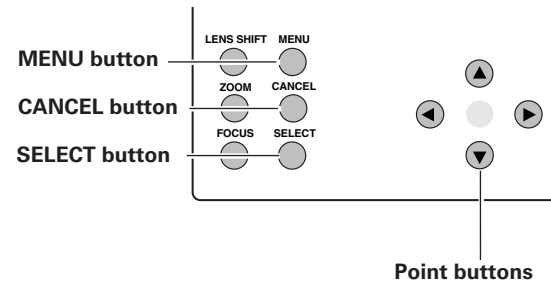

Remote Control Operation

- 1** Press the MENU button on the remote control to display the On-Screen Menu.
- 2** Gently tap on the Control pad on the remote control to spin Menu icons. When the desired Menu icon comes right in front, press the SELECT button to display the submenu.
- 3** Gently tap on or move your finger across the Control pad to select an item to adjust.
- 4** Press the SELECT button to show the item data. Adjust the data or select the desired setting with your fingertip operation on the Control pad.

✓ Note:

- The selected item is not active until the SELECT button is pressed.
- To return to the previous menu or cancel the selection, press the CANCEL button.

Remote Control

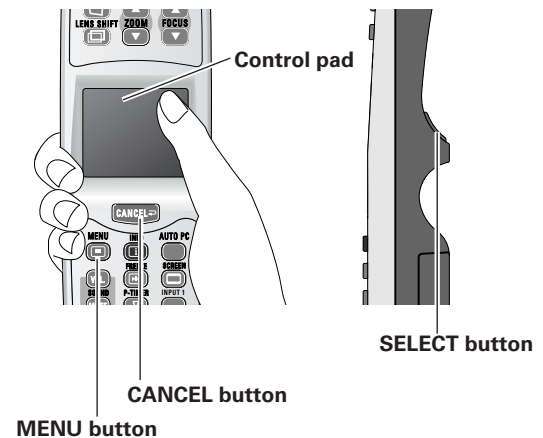

Mouse Operation

- 1** Click your mouse to display the On-Screen Menu.
- 2** Point to the desired Menu icon and click to display the submenu, or click ◀▶ or ◀◀▶▶ on the Control bar to spin Menu icons. Click SELECT when the desired Menu icon is right in front.
- 3** Click an item to show the item data to adjust or the dialog box to select a setting.
- 4** Click ▲▼ or move the bar up and down to adjust the data or click at the desired setting.

✓ Note:

- To return to the previous menu or cancel the selection, right-click your mouse.

On-Screen Menu

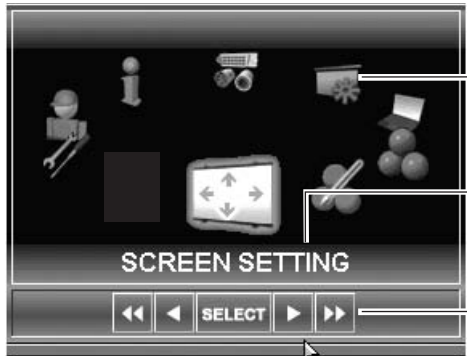

Menu icon

Guide
Currently selected menu.

Control bar for Mouse Operation

This bar appears when a USB mouse is connected to the USB terminal of the projector.

Mouse cursor

When clicking ◀◀ or ▶▶ on the control bar, menu icons rotate fast. When clicking ◀ or ▶, menu icons rotate one by one by every clicking.

When the desired Menu icon comes right in front, click SELECT or press the SELECT button on the top control or remote control.

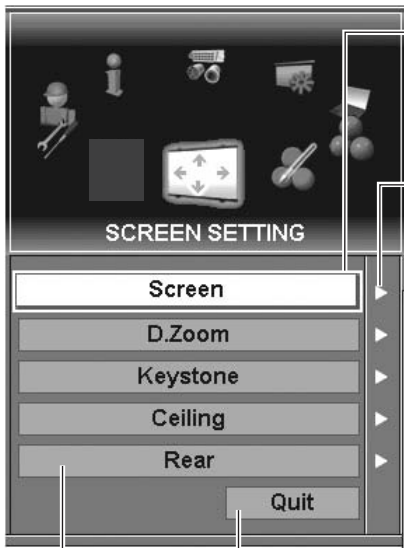

Pointer (Yellow frame)

Move the pointer with the Point buttons (▲ and ▼), Control pad or mouse cursor to select an item and press the SELECT button or click the mouse. The selected item box will turn yellow.

Navigate through items with the Point buttons (▲, ▼, ◀, and ▶), Control pad or the mouse cursor and the next item is automatically displayed.

Item

Quit
To exit this menu.

The item being selected.

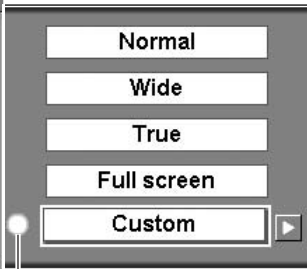

Item data

Click ▲▼ or move the bar to adjust the value.

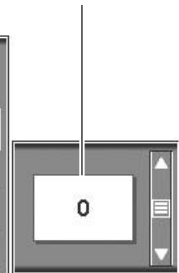
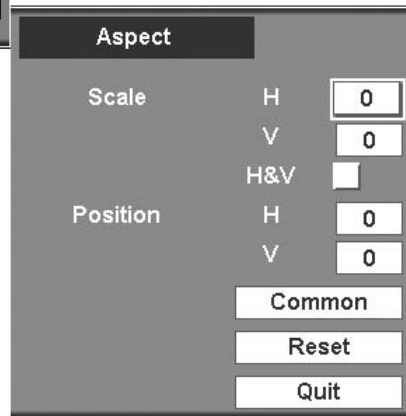









✓ **Note:**

The Control bar for Mouse Operation and the Mouse cursor do not appear with no USB mouse connected to the projector. (p25)

Menu Icons and Their Features

The projector can be adjusted or set via the On-Screen Menu. Refer to the following pages for respective adjustment and setting procedure.

Menu icons	What You Can Do with Each Menu	Page no.
	INPUT : selects input sources. Before selecting input sources with the top control or the remote control, correct input source should be selected through menu operation.	36~37
	SYSTEM : selects system of the connected computer and video sources.	38~39
	PC ADJ. : adjusts several features precisely for the projector to conform to your computer's signal format and project optimum image.	40~42
	IMAGE : selects image levels suitable for the connected image source and allows you to select the image data stored in Image Adjust Menu.	43
	IMAGE ADJ. : adjusts each picture component of the projected image in detail and store the adjusted image data in the projector to reproduce the customized image quality anytime.	44~46
	SCREEN SETTING : selects screen aspect, adjusts vertical and horizontal scales, picture position, sets the projection method (Ceiling and Rear), and activates keystone and digital zoom functions.	47~48
	SETTING : sets up operating environment for various features of the projector.	49~56
	SPECIAL : sets up operating environment of the projector and serves to the projector's maintenance.	57~59
	INFORMATION : displays current setting information and operating conditions of the projector, and allows you to check under what condition the projector is operating.	59



Input

selects computer and video input sources.

- 1 Press the MENU button to display the On-Screen Menu. Spin Menu icons with the Point buttons (◀ and ▶) or the Control pad and press the SELECT button when the INPUT icon comes right in front.
- 2 Move the yellow frame pointer with the Point buttons (▲ and ▼) or the Control pad to a input which you want to select.
- 3 Press the SELECT button to access Source Select Menu for the input selected. Select a source from the Source Select Menu and press the SELECT button.

Input Menu

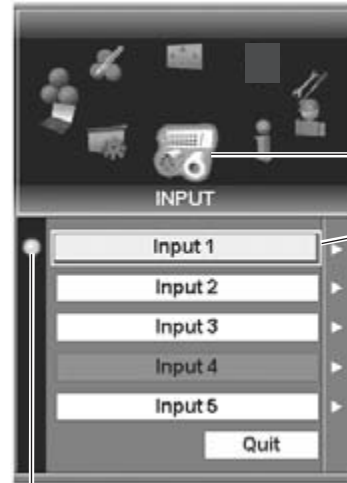

Input icon

Move the pointer (yellow frame) to an input that you want to select and press the SELECT button.

The item being selected.

Input 1

Move a pointer to Input 1 and press the SELECT button.

RGB (PC Analog) When the input source is analog coming from a computer through the Input 1 (ANALOG IN) terminal, select RGB (PC Analog).

RGB (Scart) When the input source is coming from video equipment connected to the Input 1 (ANALOG IN) terminal with a Scart-VGA Cable, select RGB (Scart).

RGB (PC Digital) When the input source is digital coming from a computer through the Input 1 (DVI) terminal, select RGB (PC Digital).

RGB (AV HDCP) When the input source compatible with HDCP is coming from video equipment through the Input 1 (DVI) terminal, select RGB (AV HDCP).

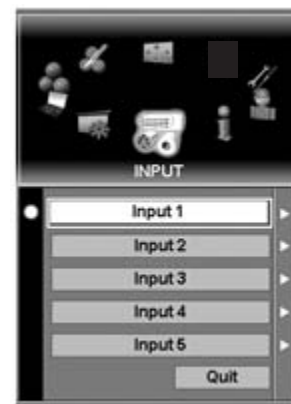

Source Select Menu

Move the pointer to RGB(PC Analog), RGB (Scart), RGB(PC Digital), or RGB(AV HDCP) and press the SELECT button.

✓ Note:

HDCP (High-bandwidth Digital Content Protection) is a system for protecting digital entertainment content delivered by DVI (Digital Visual Interface) from being copied. The specification of HDCP is decided and controlled by Digital Content Protection, LLC. Should the specification be changed, this projector may not display the digital content protected by HDCP.

Input 2

Move a pointer to Input 2 and press the SELECT button.

- RGB** When the input source is analog coming from a computer through the Input 2 (5 BNC-type: Red, Green, Blue, H. Sync., and V. Sync.) terminal, select RGB.
- Video** When video input signal is connected to the Input 2 (VIDEO) terminal, select Video.
- Y, Pb/Cb, Pr/Cr** When the input source is component coming from video equipment connected to the Input 2 (Y, Pb/Cb, Pr/Cr) terminal, select Y, Pb/Cb, Pr/Cr.

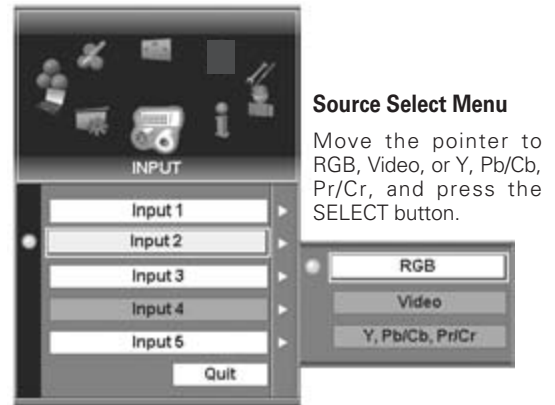

Source Select Menu
Move the pointer to RGB, Video, or Y, Pb/Cb, Pr/Cr, and press the SELECT button.

Input 3

Move a pointer to Input 3 and press the SELECT button.

- Video** When video input signal is connected to the Input 3 (VIDEO) terminal, select Video.
- Y, Pb/Cb, Pr/Cr** When the input source is component coming from video equipment connected to the Input 3 (Y, Pb/Cb, Pr/Cr) terminal, select Y, Pb/Cb, Pr/Cr.
- S-Video** When video input signal is connected to the Input 3 (S-VIDEO) terminal, select S-Video.

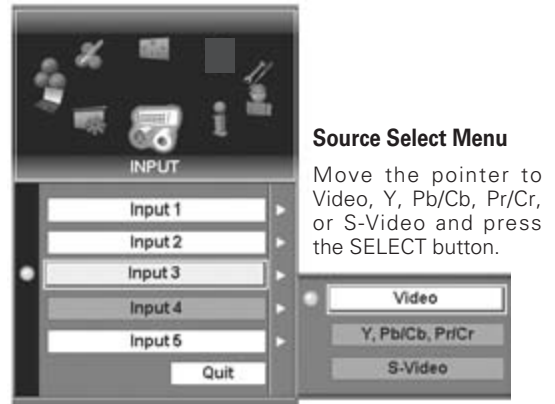

Source Select Menu
Move the pointer to Video, Y, Pb/Cb, Pr/Cr, or S-Video and press the SELECT button.

Input 4/Input 5

A source menu appears corresponding to the board module inserted into the Input 4 and Input 5 terminals.

- ✓ **Note:**
- Input 4 and Input 5 can not be selected when no interface board is inserted into the respective slots. (p21)
 - Input 5 terminal can only accept digital signals.
 - Adjusted values or selected settings in Input 4 and Input 5 return to factory default setting when the connected interface boards are removed from those terminal slots.



System

selects system of the connected computer and video source.

PC System Selection

Auto

This projector automatically tunes to various types of computers based on VGA, SVGA, XGA, SXGA, UXGA, or WXGA with its Multi-scan system and Auto PC Adjustment. If Computer source is selected in the Source Select Menu, this projector automatically detects the signal format and tunes to project a proper image without any additional setting. (Signal formats provided in this projector is shown on pages 70~71)

✓ Note:

The projector may display one of the following messages.

Mode 1 User preset system manually adjusted in PC Adjust menu. Adjustment data can be stored in Mode 1~50. (p41~42)

SVGA 1 PC Systems provided in the projector. The projector chooses a proper system and displays it.

---- There is no signal input from computer. Check the connection of your computer and the projector. (See "Troubleshooting" on page 68)

*SVGA 1 and Mode 1 are examples.

Selecting PC System Manually

When the projector has difficulty in recognizing the connected signal conforming to PC Systems provided in this projector, several systems are displayed. Select one from them manually. When the image is not projected properly, manual adjustment is required. (p41~42)

- 1 Press the MENU button to display On-Screen Menu. Spin Menu icons with the Point buttons (◀ and ▶) or the Control pad and press the SELECT button when the SYSTEM icon comes right in front.
- 2 Move the yellow frame pointer with the Point buttons (▲ and ▼) or the Control pad to a proper system, and then press the SELECT button.

PC System Menu

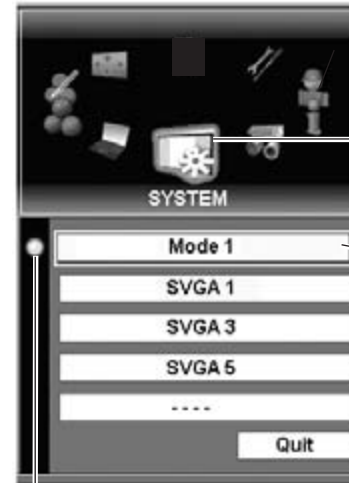

System icon

Custom Mode (1~50) set in the PC Adjust Menu. (p41, 42)

The system being selected.

Video or S-Video Signal Selection

Auto

The projector automatically detects incoming video system, and adjusts itself to optimize its performance. When Video System is PAL-M or PAL-N, select system manually.

PAL / SECAM / NTSC / NTSC4.43 / PAL-M / PAL-N

If the projector cannot reproduce proper video image, it is necessary to select a specific broadcast signal format from among PAL, SECAM, NTSC, NTSC 4.43, PAL-M, and PAL-N.

✓ Note:
When Auto is selected for the System menu, PAL-M and PAL-N cannot be selected.

AV System Menu (Video or S-Video)



Move the yellow frame pointer to a system and press the SELECT button to activate it.

Component Signal Selection

Auto

The projector automatically detects incoming video signal, and adjusts itself to optimize its performance.

COMPONENT VIDEO SIGNAL FORMAT

If the projector cannot reproduce proper video image, it is necessary to select a specific component video signal format from among 480i, 575i, 480p, 575p, 720p, 1035i, 1080i/50, and 1080i/60.

AV System Menu (Component)



Move the pointer to a system and press the SELECT button to activate it.



PC Adjustment

selects Auto PC adj., Fine sync, Total dots, Current mode, Clamp, Display area, Position, V-sync phase, Reset, and Mode.

Auto PC Adjust

Auto PC adj.

- 1 Press the MENU button to display On-Screen Menu. Spin Menu icons with the Point buttons (◀ and ▶) or the Control pad and press the SELECT button when the PC ADJ. icon comes right in front.
- 2 Move the yellow frame pointer to Auto PC adj. and then press the SELECT button twice.
This Auto PC Adjustment can be also executed by pressing the AUTO PC ADJ. button on the top control or the AUTO PC button on the remote control unit. (p15, 30)

To store adjustment parameters

Adjustment parameters from Auto PC Adjustment can be memorized in this projector. Once parameters are memorized, the setting can be done just by selecting Mode in the System menu (p38). See Store on page 42.

✓ Note:

- Fine sync, Total dots and Picture Position of some computers can not be fully adjusted with this Auto PC Adjustment function. When the image is not provided properly with this operation, manual adjustments are required. (p41, 42)
- Auto PC Adjustment function cannot be operated in Digital Signal input on DVI terminal and 480i, 575i, 480p, 575p, 720p (HDTV), 1035i (HDTV), 1080i/50 (HDTV), or 1080i/60 (HDTV) is selected on the System menu. (p39)

PC Adjust Menu

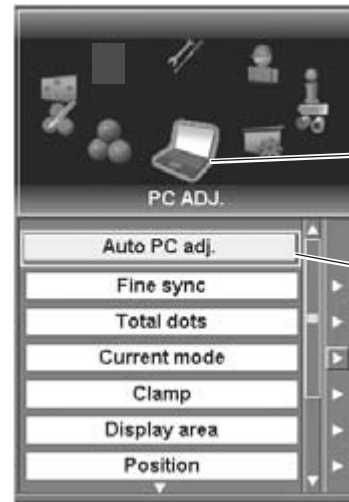

PC ADJ. icon

Move the yellow frame pointer to the Auto PC adj. and press the SELECT button.

Manual PC Adjust

Some computers employ special signal formats which may not be tuned by Multi-scan system of this projector. Manual PC Adjustment enables you to precisely adjust several parameters to match those signal formats. The projector has 50 independent memory areas to memorize those parameters adjusted manually. It allows you to recall the setting for a specific computer easily.

- 1 Press the MENU button to display On-Screen Menu. Spin Menu icons with the Point buttons (◀ and ▶) or the Control pad and press the SELECT button when the PC ADJ. icon comes right in front.
- 2 Move the yellow frame pointer with the Point buttons (▲ and ▼) or the Control pad to an item which you want to select.
- 3 Press the SELECT button to access an adjustment dialog box. Adjust value with the Point buttons (▲ and ▼) or the Control pad.

Fine sync

Eliminates flicker from the image displayed. Adjust value with the Point buttons (▲ and ▼) or the Control pad.
(From 0 to 31)

Total dots

Adjusts the number of total dots in one horizontal period. Adjust number to match your PC image with the Point buttons (▲ and ▼) or the Control pad.

Current mode

Press the SELECT button to show H-Freq. and V-Freq. of the connected computer.

Clamp

Adjusts clamp level (Phase and Width). When the image has dark bars, try this adjustment.

Display area

Adjusts the resolution at the Display area dialog box.

Horizontal

Adjusts the horizontal area displayed by this projector. Decrease or increase value with the Point buttons (▲ and ▼) or the Control pad.

Vertical

Adjusts the vertical area displayed by this projector. Decrease or increase value with the Point buttons (▲ and ▼) or the Control pad.

PC Adjust Menu

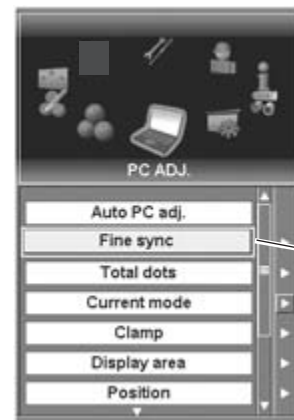

Move the yellow frame pointer to an item and press the SELECT button.



Adjust value with the Point buttons (▲ and ▼) or the Control pad.



Current mode

Press the SELECT button at the Current mode to show the information of the connected computer.

Position

Adjusts picture position.

V-sync phase

Adjust this item when the projected image is affected by the noise from the external equipment. (From 0 to 15)

✓ Note:

V-sync phase is not displayed as the item is initially checked off on My menu in the Setting menu. Change the My menu setting in the Setting menu (p49) when necessary to adjust V-sync. phase.

Reset

Resets all adjustments to their previous levels.

Mode

To store the adjustment data or clear the stored data, move the yellow frame pointer to Mode and then press the SELECT button.

Store

To store the adjustment data, select Store and press the SELECT button to display Mode dialog box. Move the yellow frame pointer to any of Mode 1 to 50 in which you want to store and then press the SELECT button.

Free

To clear the adjustment data previously set, select Free and press the SELECT button to display Mode dialog box. Move the yellow frame pointer to any of Mode 1 to 50 in which you want to clear and then press the SELECT button.

Quit

Exits the PC Adjust Menu.

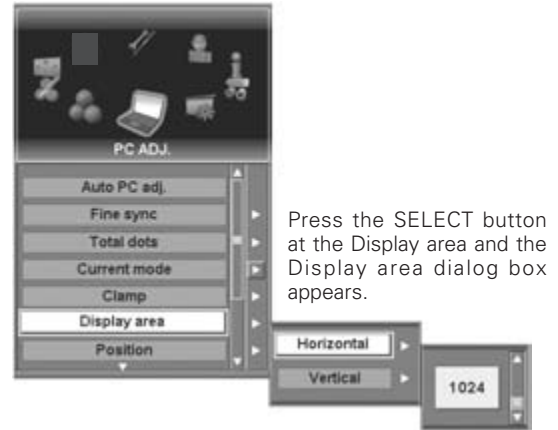

Press the SELECT button at the Display area and the Display area dialog box appears.

To store adjustment data



Vacant Mode

shows the selected input, source and system, and values of "Fine sync," "Total dots," "Clamp," "Display area," and "Position."

To clear adjustment data



✓ Note:

Fine sync. and Display area cannot be selected when 480i, 575i, 480p, 575p, 720p, 1035i, 1080i/50, or 1080i/60 is selected in the System menu. (p39)

Image Adjustment



Image

selects image level from Standard, Cinema, Real, and Image 1~10.

- 1 Press the MENU button to display On-Screen Menu. Spin Menu icons with the Point buttons (◀ and ▶) or the Control pad and press the SELECT button when the IMAGE icon comes right in front.
- 2 Move the yellow frame pointer with the Point buttons (▲ and ▼) or the Control pad to an image level which you want to select and then press the SELECT button.

For PC Input

Standard

Normal picture level preset on this projector for PC mode.

Real

Picture level with improved halftone for graphics.

IMAGE 1~10

User preset picture adjustment in IMAGE ADJ. menu (p44~46).

For AV Input

Standard

Normal picture level preset on this projector for AV mode.

Cinema

Picture level adjusted for picture with fine tone.

IMAGE 1~10

User preset picture adjustment in IMAGE ADJ. menu (p44~ 46).

✓ **Note:**

Image 1~10 are common for PC and AV sources, which means 10 memory areas are prepared for PC and AV sources totally.

Image Menu (PC)

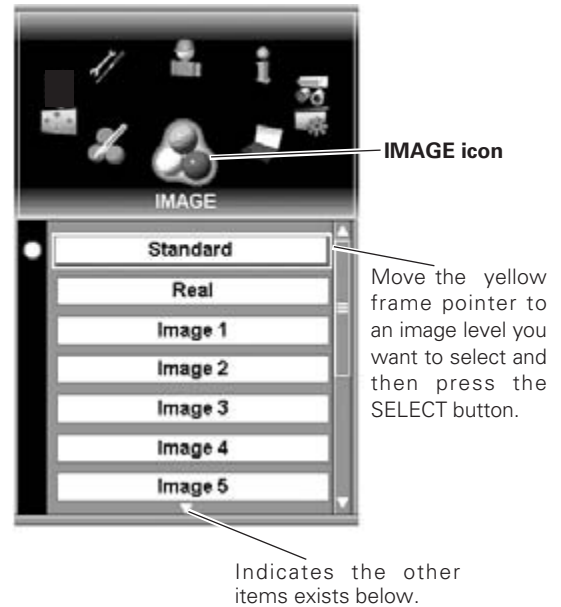

Image Menu (AV)





Image Adjust

adjusts Contrast, Brightness, Color, Tint, Color management, Auto picture control, Color temp., Red, Green, Blue, Sharpness, Gamma, Noise reduction, Progressive, and Film; selects Reset and Store.

- 1 Press the MENU button to display On-Screen Menu. Spin Menu icons with the Point buttons (◀ and ▶) or the Control pad and press the SELECT button when the IMAGE ADJ. icon comes right in front.
- 2 Move the yellow frame pointer with the Point buttons (▲ and ▼) or the Control pad to an item which you want to adjust.
- 3 Press the SELECT button to display an adjustment dialog box. Adjust value with the Point buttons (▲ and ▼) or the Control pad.

Contrast

Decrease or increase contrast with the Point buttons (▲ and ▼) or the Control pad. (From 0 to 63.)

Brightness

Adjust image darker or brighter with the Point buttons (▲ and ▼) or the Control pad. (From 0 to 63.)

Color

Lighten or deeper color with the Point buttons (▲ and ▼) or the Control pad. (From 0 to 63.)

Tint

Adjust with the Point buttons (▲ and ▼) or the Control pad to obtain proper color. (From 0 to 63.)

Color management

The Color management function enables you to adjust color level, phase and gamma of the selected spot of the projected image and exchange the original color with the adjusted one. The projector can store up to eight color management data.

Color selection

Press the SELECT button when Color management is highlighted and then Color management pointer will appear. Move the pointer to a spot which you want to adjust the color of with the Point buttons (▲, ▼, ◀, and ▶) or the Control pad, and press the SELECT button. The image being projected freezes and Color Selection window will appear.

X-axis of COLOR pallet shows Phase and Y-axis, Level.

Select a level and phase which you prefer with the Point buttons (▲, ▼, ◀, and ▶) or the Control pad and press the SELECT button to move the pointer to GAMMA.

Select a position of GAMMA which you prefer with the Point buttons (▲ and ▼) or the Control pad and press the SELECT button.

While adjusting COLOR and GAMMA, the projected image color will change accordingly.

✓ Note:

- Color and Tint cannot be displayed when PC input source is selected.
- Tint cannot be adjusted when the video system is PAL, SECAM, PAL-M, or PAL-N. (p.39)

Image Adjust Menu

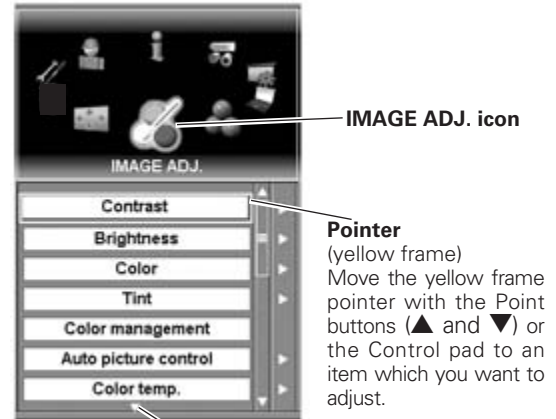

Indicates the other items exists below.

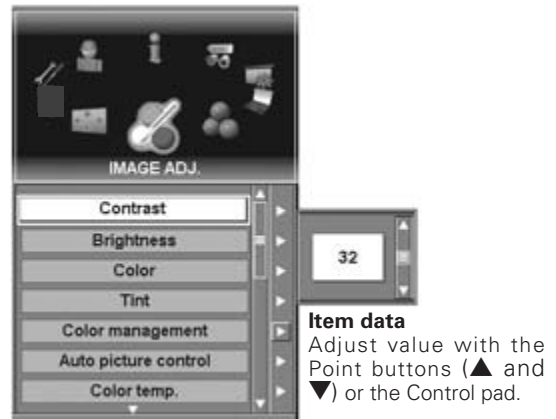

Color selection



Color management pointer

Move the pointer to a spot which you want to adjust the color of and then press the SELECT button. Color Selection window will appear as shown below.



Move the pointer to one of the followings with the Point buttons (▲, ▼, ◀, and ▶) or the Control pad and press the SELECT button.

LIST.....displays Color Management List window to store the adjustment data.

COLOR.M ..returns to the previous image with the Color management pointer.

MENUdisplays a confirmation dialog box. Select [Yes] to return to the menu display.

Color management list

After selecting LIST on the Color selection window, Color Management List will appear. Move the pointer to one of the followings with the Point buttons (▲, ▼, ◀, and ▶) or the Control pad and press the SELECT button.

ALL DEL.....deletes all the data on the list.

MENUdisplays a confirmation dialog box. Select [Yes] to return to the menu display.

COLOR M...returns to the previous image with the Color management pointer.

Press the CANCEL button to exit the Color management mode.

Auto picture control

With this function enabled, the projected image will be easier to see by emphasizing black of the picture. Select one from the following settings:

Offdisabled

L1 emphasizes black of the picture.

L2emphasizes black of the picture greater than L1.

Color temp.

Select a level from among XLow, Low, Mid and High with the Point buttons (▲ and ▼) or the Control pad and the SELECT button.

Red

Lighten or deepen red tone of the picture with the Point buttons (▲ and ▼) or the Control pad. (From 0 to 63.)

Green

Lighten or deepen green tone of the picture with the Point buttons (▲ and ▼) or the Control pad. (From 0 to 63.)

Blue

Lighten or deepen blue tone of the picture with the Point buttons (▲ and ▼) or the Control pad. (From 0 to 63.)

✓ Note:

If either value of Red, Green, and Blue is adjusted, "Adj." will be selected in Color temp. automatically.

Sharpness

Soften or sharpen the image with the Point buttons (▲ and ▼) or the Control pad. (From 0 to 15.)

Color management list



Move the pointer to the selected color and press the SELECT button. The confirmation dialog box appears.



Clear the check mark with the SELECT button not to apply the adjusted color to the projected image.

Select [Yes] to return to the menu display.



The setting selected.

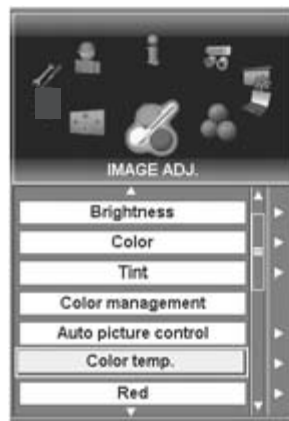

The setting selected.

Gamma

Adjust with the Point buttons (▲ and ▼) or the Control pad to obtain better balance of contrast. (From 0 to 15.)

Noise reduction

Select one of the followings to reduce noise of the image.

- Offdisabled
- L1Select "L1" for an active picture.
- L2Select "L2" for a still picture.

Progressive

With this function "On", interlaced video signal is displayed in a progressive picture.

Film

This function is effective on 2:3 or 2:2 pulldown video sources. With this function "On", the projector reproduces pictures faithful to the original film quality.

Store

To store the adjustment data, move an yellow frame pointer to Store and press the SELECT button. Image Level Menu will appear. Move the yellow frame pointer to one of Image 1~10 and then press the SELECT button.

Reset

Reset all adjustments to their previous figures.

Quit

Exits Image Adjust menu.

✓ Note:

- Progressive, Film, and Noise reduction cannot be displayed when selecting PC input source.
- Progressive cannot be selected when 480p, 575p, and 720p is selected in the System menu. (p39)
- Film can only be activated when selecting PAL, NTSC, 480i, or 575i for Video System and "On" for Progressive.
- 2:3 Pulldown or Telecine transfer is the process of changing images from film mode to video mode. While film runs at 24 frames per second (fps), NTSC television signals (or video) have a run rate of 30fps so the 24 fps film needs to be speeded up to 30fps and transferred using a proper field pattern to get the best film-like images. 2:2 Pulldown uses the same process of changing images as 2:3 pulldown, but the difference is that 24 fps film is speeded up for PAL television signal (or video) having 25 fps.

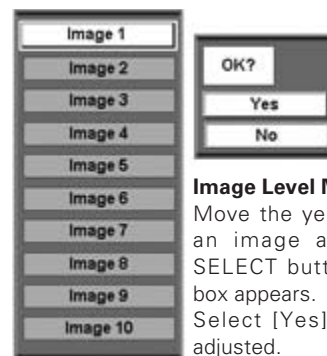
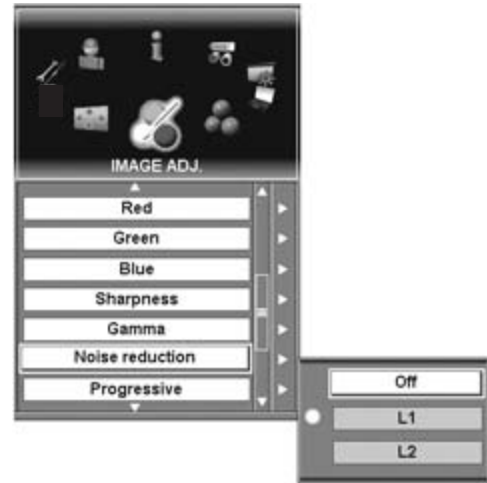

Image Level Menu

Move the yellow frame pointer to an image and then press the SELECT button. The confirmation box appears. Select [Yes] to store the image adjusted.

Screen Setting



Screen Setting

selects the screen size from Normal, Wide, True, and Full screen; customizes it by Scale, H&V, Position, Common, and Reset; adjusts it by Digital zoom +/-, Keystone; sets Ceiling and Rear.

- 1 Press the MENU button to display On-Screen Menu. Spin Menu icons with the Point buttons (◀ and ▶) or the Control pad and press the SELECT button when the SCREEN SETTING icon comes right in front.
- 2 Move the yellow frame pointer with the Point buttons (▲ and ▼) or the Control pad to an item which you want to select.

Screen

Normal

Provides image to fit screen size.

Wide

Provides image to fit wide video aspect ratio (16:9) by expanding image width uniformly. This function can be used for providing a squeezed video signal at 16:9.

True

Provides image in its original size. When the original image size is larger than the screen size, this projector enters panning mode automatically. While "True" is displayed on screen, pan the image with the Point buttons (▲, ▼, ◀, and ▶) or the Control pad. Digital zoom + and - mode can be switched by pressing the SELECT button.

Full screen

Provides image to fit the horizontal size of the screen size. When the input signal is SXGA (5:4), the image is fully displayed at 4:3 aspect ratio.

Custom (Aspect)

Adjusts aspect (scale and position) of the screen. Press the SELECT button at Custom. Custom will be displayed on the top left of the screen for four (4) seconds and then return to the previous menu display. Press the SELECT button again with the pointer stayed on Custom to display Aspect setting menu. Adjust each value of Scale and Position.

Scaleadjusts horizontal and vertical scale of the screen.
(From -32 to +32)

H&Vchanges Vertical value subject to Horizontal value; when a checkmark is put on H&V, Scale V cannot be adjusted.

Position . . .adjusts horizontal and vertical position of the screen. (From -15 to +15)

Common . . .applies the current Aspect setting to all the Inputs.

Resetresets all adjusted values to zero.

Quitexits the Aspect setting menu.

✓ Note:

The adjusted aspect can basically be memorized for each input even if the projector is turned off.

Screen Setting Menu

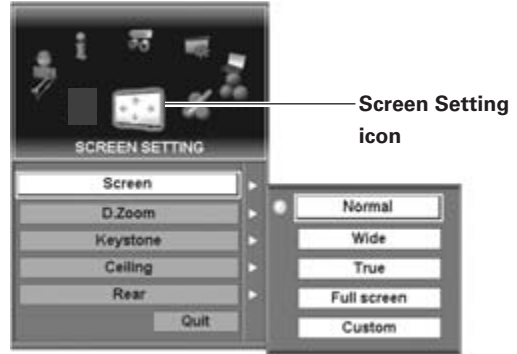

Screen (Custom)

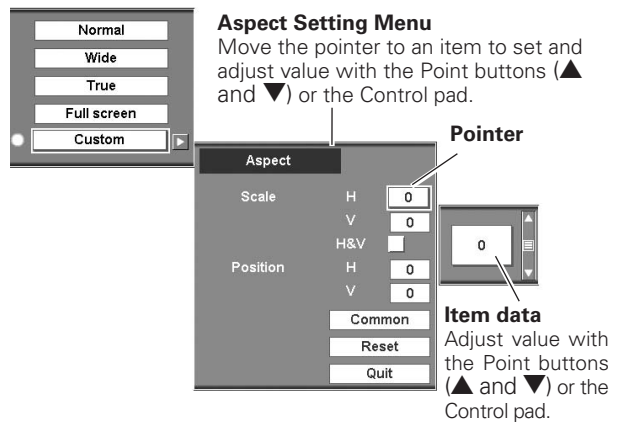

Screen (Custom: H&V)

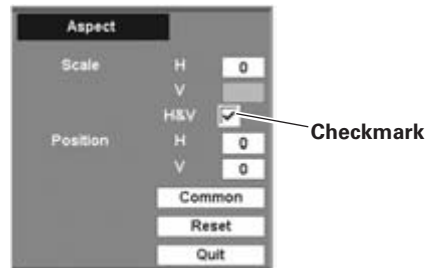

Screen (Custom: Common)

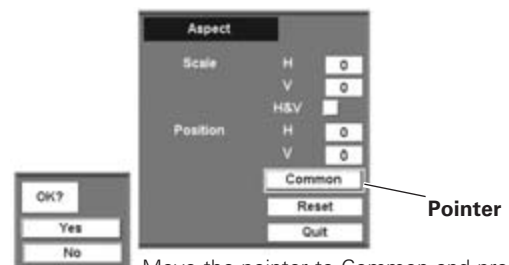

Move the pointer to Common and press the SELECT button. The confirmation box appears. Select [Yes] to activate it.

D. Zoom

D. Zoom +

Press the SELECT button at the D. Zoom +. The message "D. Zoom +" is displayed. Press the SELECT button to expand the image size. And use the Point buttons (▲, ▼, ◀, and ▶) or the Control pad to pan the image. The Panning function can work only when the image is larger than the screen size.

D. Zoom -

Press the SELECT button at the D. Zoom -. The message "D. Zoom -" is displayed. Press the SELECT button to compress the image size.

✓ **Note:**

To exit the D. Zoom +/- mode, try the followings:

- To return to the normal screen, change Input, or change the screen size.
- To exit the panning mode, press any button except the D. ZOOM button, the SELECT button, and the CH and ID buttons.

Keystone

This function corrects distortion of a projected image. Press the SELECT button at Keystone and the keystone dialog box appears. Adjust keystone with the Point buttons (▲, ▼, ◀, and ▶) or the Control pad.

Press the Point ▶ button or the Control pad at Keystone and select either Store or Reset with the Point buttons (▲ and ▼) or the Control pad, and then press the SELECT button to fix the selection.

Storestores the keystone adjustment even if the AC power cord is disconnected.

Resetresets the keystone adjustment when the AC power cord is disconnected.

Ceiling

When this function is "On," the picture is top/bottom and left/right reversed. This function is used to project the image from a ceiling mounting the projector.

Rear

When this function is "On," the picture is left/right reversed. This function is used to project the image to a rear projection screen.

✓ **Note:**

- The True and D. Zoom +/- cannot be selected when projecting AV sources or selecting "480i", "575i", "480p", or "575p" in the System menu (p38~39).
- This projector cannot display any resolution higher than 1600 X 1200. If your computer's screen resolution is higher than 1600 X 1200, reset the resolution to the lower before connecting the source to the projector.
- The image data in other than XGA (1024 x 768 for LC-X6A) or SXGA (1400 x 1050 for LC-SX6A) is modified to fit the screen size in initial mode.
- The panning function may not operate properly if the computer system prepared in the PC Adjust Menu is used.

D. Zoom

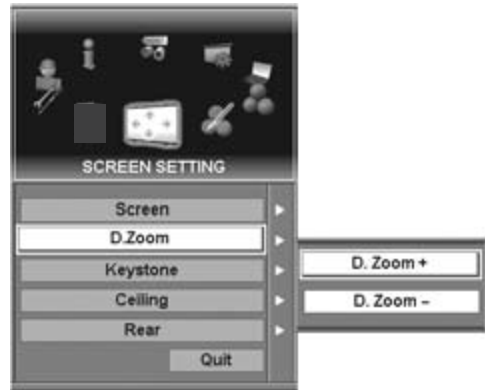

Keystone

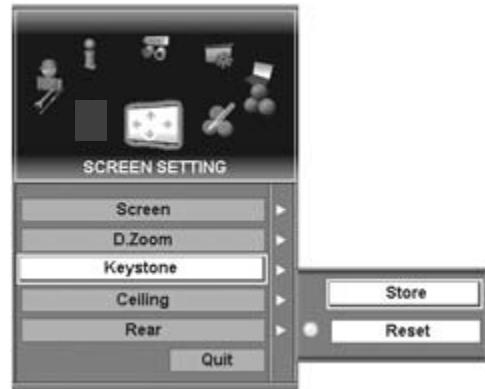

Ceiling

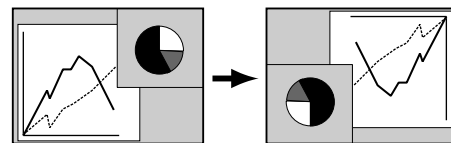

Rear

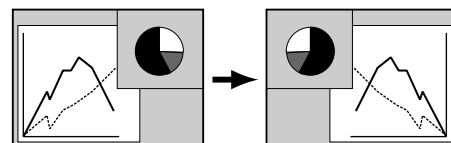



Setting

changes various settings: Language, Menu, Logo, Background, Lamp, Remote control, Display, Input search, Power management, On start, Analog out, Lens memory, Shutter, Security, and Factory default.

- 1 Press the MENU button to display On-Screen Menu. Spin Menu icons with the Point buttons (◀ and ▶) or the Control pad and press the SELECT button when the SETTING icon comes right in front.
- 2 Move the yellow frame pointer with the Point buttons (▲ and ▼) or the Control pad to an item which you want to set and then press the SELECT button. The Setting dialog box appears.

Language

The language used in the On-Screen Menu is available in English, German, French, Italian, Spanish, Portuguese, Dutch, Swedish, Russian, Chinese, Korean, or Japanese.

Menu

This feature allows you to change the On-Screen Menu setting.

Position

When Position is selected, arrows appear in upward, downward, right and left directions on the screen. Move the menu position with the Point buttons (▲, ▼, ◀, and ▶) or the Control pad and fix it by pressing the SELECT button.

My menu

This feature enables you to customize the On-Screen menu display. Put checkmarks on items of each menu that you want to display.

Simple menu

OnWhen adjusting value in the Image adjust menu, the value adjustment bar is displayed on the bottom left of the screen.

OffDefault setting.

✓ **Note:**

- Input and Menu items cannot be hid with the My menu setting.
- When selecting Default on My menu setting, all items of the On-Screen Menu will be displayed.

Setting Menu (Language)

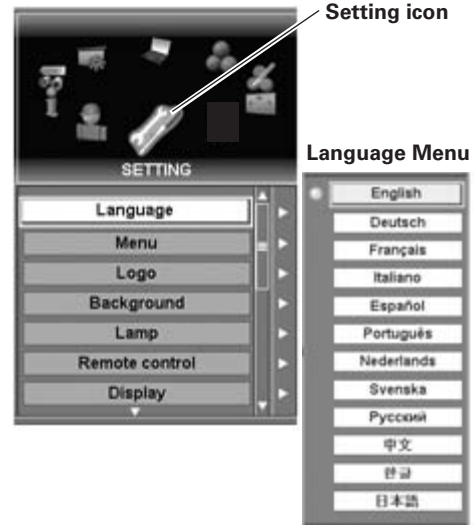

Menu Position

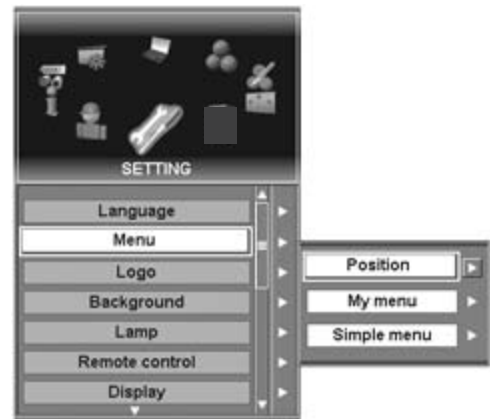

My Menu

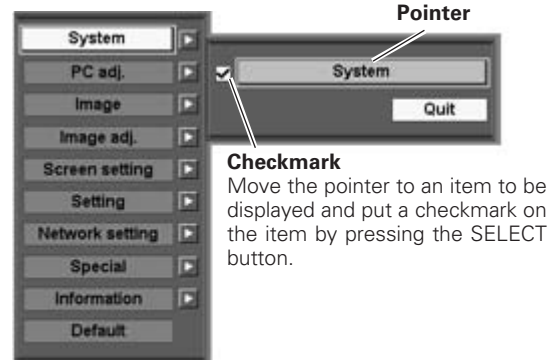

Logo

Logo settings can be altered as follows:

Logo select

This function decides what to be displayed on the starting-up display as follows:

- Defaultthe factory-set logo
- My logothe image you captured
- Offcount-down only

Capture

This function enables you to capture the image being projected and use it for a starting-up display or interval of presentations.

After capturing the projected image, go to the Logo function and set it to "My logo". Then the captured image can be displayed when turning on the projector next time. (p27)

To capture the image, select [Yes]. To cancel the Capture function, select [No].

✓ Note:

- Before capturing an image, select Standard in the Image Menu to capture a proper image. (See page 43.)
- Certain signals may not be captured properly.
- When capturing the image that has been adjusted by the Keystone function, the adjustment data is automatically reset and the projector captures an image without keystone correction.
- Once you exit the Logo menu after setting Logo lock to "On", you are required to enter the PIN code every attempting to change the Logo setting.

Lock

This function prevents an unauthorized person from changing the Logo setting.

- Offthe Logo setting can be changed freely from the Logo menu.
- Onthe Logo setting cannot be changed without PIN code.

If you want to change the Logo Lock setting, enter a PIN code along the following steps. The initial PIN code for Logo Lock setting is set "4321" at the factory.

Enter a Logo PIN code

Select a number with the Point buttons (▲, ▼, ◀, and ▶) or the Control pad and fix the number with the SELECT button. The number will change to "*". If you fixed a wrong number, move the pointer to "C" with the Point buttons (▲, ▼, ◀, and ▶) or the Control pad, then enter the correct number.

Repeat this step to complete entering a four-digit number.

When the four-digit number is fixed, move the pointer to "Ent". Press the SELECT button so that you can change the Logo Lock setting.

If you entered a wrong Logo PIN code, "Logo PIN code" and the number (****) will turn red and disappear. Enter a Logo PIN code all over again.

Logo Select

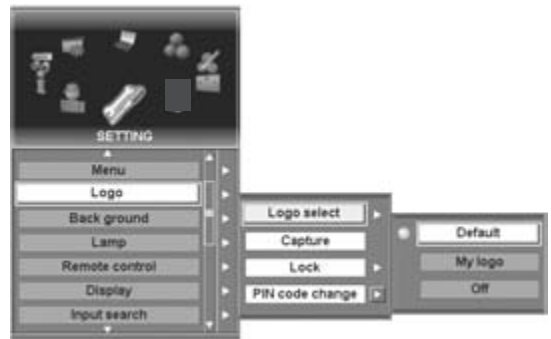

Capture

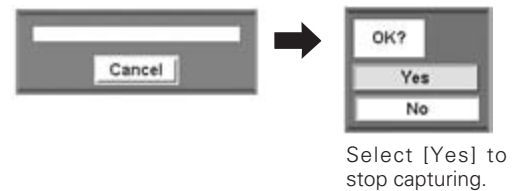
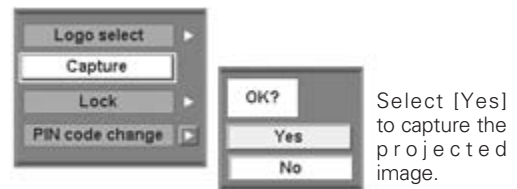

Logo Lock Setting

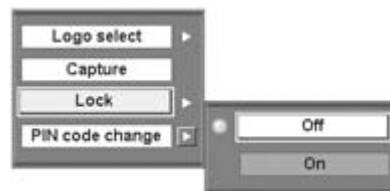

Enter a Logo PIN code

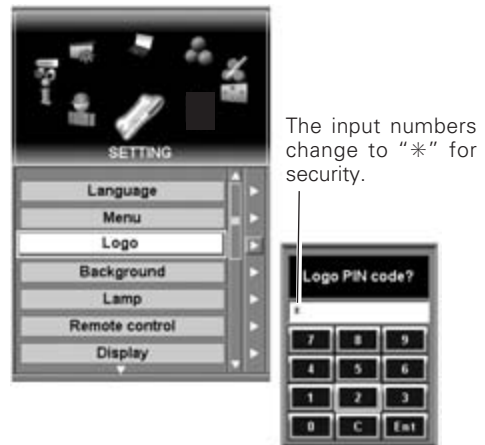

PIN Code Change

Logo PIN code can be changed to your desired four-digit number. Select "PIN code change" with the Point buttons (▲, ▼, ◀, and ▶) or the Control pad and press the SELECT button. Set a new Logo PIN code.

Be sure to note the new Logo PIN code and keep it at hand. If you lost the number, you could no longer change the Logo PIN code setting. For details on PIN code setting, refer to relevant instructions of the PJ Lock function on page 55.

Background

Three background settings are available in this projector. Select one of the followings when no input source is connected to the projector or no input signal is coming from the connected equipment:

- Blueblue colored background
- My logo . . .the image you captured
- Blackblack colored background

Lamp

Control

This feature allows you to change brightness of the screen.

- Normal . .normal brightness
- Autobrightness according with the input signal
- Ecolower brightness reduces the lamp power consumption and extends the lamp life.

Mode

This projector is equipped with two lamps. Mode setting allows you to switch using one (1) lamp or two (2) lamps.

- 2-Lamplight both of the lamps inside the projector.
- 1-Lamplight one lamp only. Auto, Lamp 1, or Lamp 2 can be altered.

✓ Note:

- When neither of the two lamps is lighted, the projector will shutdown automatically.
- When either of the two lamps does not light up, the LAMP 1/2 REPLACE indicator blinks orange and the projector will light the other automatically.
- After changing the lamp mode, it cannot be switched again for 90 seconds.

Remote control

Four (4) remote control channels and eight (8) remote control ID are prepared for the projector to prevent radio frequency interference from the other equipment and mutual interference between projectors when using them at the same time.

For example, operating the projector in "CH-2 and ID-7," both the projector and the remote control must be switched to "CH-2 and ID-7."

To change CH and ID for the projector:

Select a Remote control CH and ID in this Setting menu.

To change CH and ID for the remote control:

While holding down the CH or ID button and press the SELECT button. The Remote control CH or ID switches sequentially for one pressing the SELECT button. Changing CH and ID should be done separately. (See page 16 and 17 for details.)

PIN Code change Dialog Box

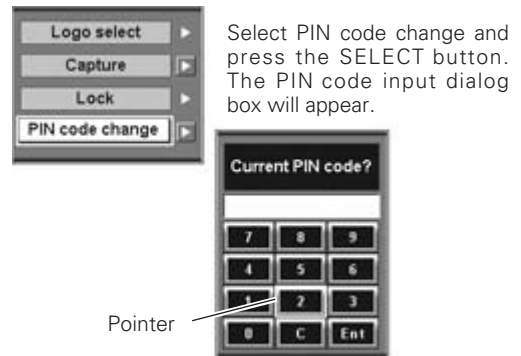

Select PIN code change and press the SELECT button. The PIN code input dialog box will appear.

Lamp Control

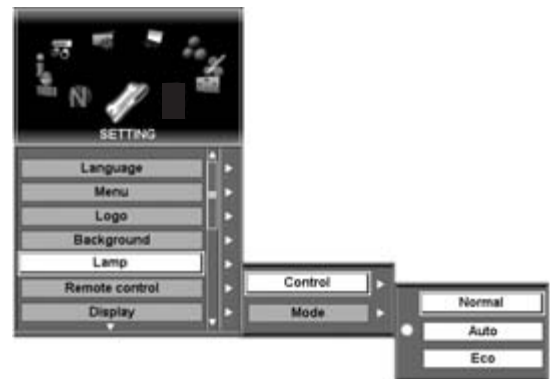

Lamp Mode

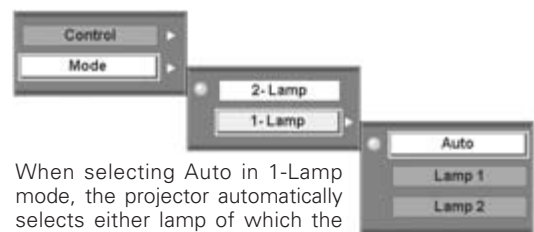

When selecting Auto in 1-Lamp mode, the projector automatically selects either lamp of which the total Lamp time is shorter and lights it up.

Remote control

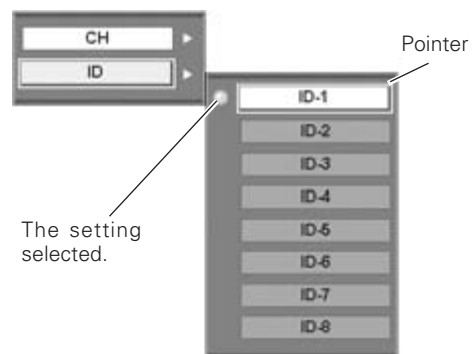

The setting selected.

When pressing the SELECT button at Remote control, the remote control CH and ID menu appears. Select CH and ID respectively.

Display

This function decides whether to display On-Screen Displays.

Onshows all the On-Screen Displays.

Offsets On-Screen Displays disappeared except;

- On-Screen Menu
- "Power off?" message
- P-TIMER
- "No signal" message
- "Please wait..." message
- "Searching..." message

Input search

With this function "On", the projector automatically starts input signal search from Input 1 to Input 5 when turning on the projector. This automatic search stops at the Input where the projector detects any input signal connected.

✓ Note:

When the last selected input source in the Input menu differs from the detected input source, the projector may not display the image properly. In this case, select input source.

Power management

For reducing power consumption as well as maintaining the lamp life, the Power Management function starts the count down when the input signal is interrupted and no button is pressed for 30 seconds or more.

If the input signal is interrupted and no button is pressed for 30 seconds or more, the timer display with the message "No signal" appears on the screen. The count-down of the set time gets started. The count-down time can be set between 1 and 60 minutes.

When the count-down time has been elapsed, the lamp is turned off to cool itself down. The LAMP indicator dims during this cooling-off period. The next operation depends on the setting as follows :

ReadyWhen the lamp has been fully cooled down, the READY indicator changes to green blinking. In this condition, the projection lamp is turned on if the input signal is reconnected or any button on the top control or remote control unit is pressed.

Shut down . . .When the lamp has been fully cooled down, the power is turned off.

OffThe Power Management function is canceled.

On start

When this function is "On," the projector is automatically turned on just by switching MAIN ON/OFF SWITCH on.

✓ Note:

Be sure to turn the projector off properly (see "Turning Off the Projector" on page 28). If the projector is turned off in the wrong steps, the On start function does not operate properly.

Power management



Time left until Lamp off

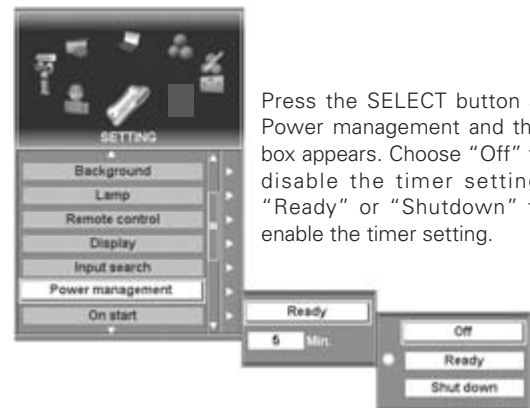

Press the SELECT button at Power management and this box appears. Choose "Off" to disable the timer setting, "Ready" or "Shutdown" to enable the timer setting.



Timer Setting

Move the pointer to the timer and set time with the Point buttons (▲ and ▼) or the Control pad and press the SELECT button. The timer window disappears and then choose "Ready" or "Shutdown" to enable the timer setting.

Analog out

The ANALOG OUT terminal is for output of the analog signal coming from the ANALOG IN terminal in the Input 1 terminals. (See page 12.)

Select "On" to enable the signal output through the ANALOG OUT terminal always except in the stand-by mode or "Off" to disable the signal output.

Analog out is not available when selecting the other Inputs except Input 1. Select Input 1 so that Analog out will be available. (p30, 36)

Lens memory

Lens memory feature enables you to store the lens shift, zoom and focus adjustment for each Input. When selecting Lens memory, Input 1~5 will be displayed. Move the pointer to an Input and press the SELECT button. Choose one of the following settings for the Input.

- Off applies the lens shift, zoom and focus adjusted last.
- Memory stores the lens shift, zoom and focus currently adjusted for each input. When switching to the input with "Memory" selected, the lens moves to the stored position.

✓ Note:

- Lens memory is available only in the lens having memory functions of itself. Contact to the sales dealer or the service station for available lens.
- 100% accurate lens memory is not guaranteed. If an accurate lens position, zoom and focus cannot be obtained with Lens memory function, adjust them respectively in each case.

Shutter

Shutter function is available to block out light to the screen, so that the screen can be used for the other presenters. In addition, this function enhances the effectiveness of contrast by 80% opening up the shutter inside the projector.

Each setting for the Shutter function can be altered as follows:

Level

Sets up shutter level when closing the mechanical shutter.

- Normal0% light blocking
- High contrast20% light blocking

Protection

Prohibits the shutter operation from the remote control and the projector's top control.

- Remote control . . . Selecting "On" prohibits the shutter operation from the remote control.
- Projector Selecting "On" prohibits the shutter operation from the top control.

It is possible to prohibit the shutter operation from both of the remote control and the top control.

Lens memory

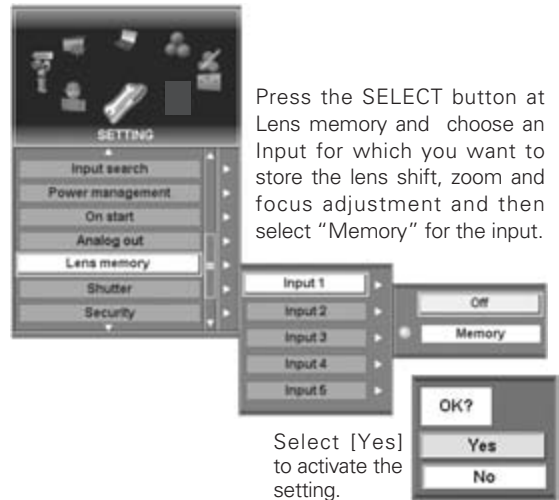

Shutter level

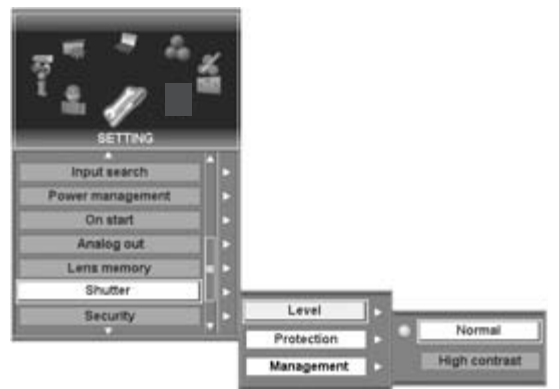

Shutter protection



When pressing the SELECT button at Shutter, the Shutter setting menu appears. Select Protection and then a desired setting for Remote control and Projector.

Shutter Management

The Shutter Management function turns off the projection lamp when the projector is left with the shutter closed and the set time has passed away. The count-down time can be set between 5 and 180 minutes.

After the count-down time has elapsed, the shutter is opened up automatically and the lamp is turned off to cool itself down. The SHUTTER indicator is blinking blue during this cooling-off period. When the lamp has been fully cooled down, the READY indicator turns green lighting and the SHUTTER indicator keeps blinking. Should the POWER button be pressed in this condition, the projection lamp is turned on and the SHUTTER indicator turns off.

✓ **Note:**

While the Shutter is closed, timer setting of the Power management is invalid.

Security

Key lock

This function locks operation from the top control and remote control. It is used to prevent the projector from being operated by an unauthorized person.

Projectorlocks operation from the top control. To unlock, use the remote control.

Remote control . . .locks operation from the remote control. To unlock, use the top control.

Offunlock any operation. To release lock, select this.

If the top control accidentally becomes locked and you do not have the remote control nearby, disconnect the AC power cord from the AC outlet, and then by hold down the SELECT button and reinsert the AC power cord. This will cancel the top control lock.

USB lock

This function prevents the projector from being operated by an unauthorized person with the optional USB key and provides the following settings for security options.

Settingkey lock setting (On1, On2, and Off)

Registration . .registers 2nd USB key into the projector. (First key can be registered by just being connected to the projector in turning on.)

Deletedeletes the registered USB keys.

To set the USB lock, the optional USB key is required. Refer to page 73 for the optional USB key and contact the sales dealer for purchasing. Refer to the owner's manual enclosed with the USB key for detail operation of the USB lock.

✓ **Note:**

- USB lock cannot be selected when the optional USB key is not connected to the projector. (p13)
- When either of USB lock or PJ lock is set, the other cannot be selected.
- USB key function can be used only with our specified optional USB key. We do not guarantee operation with the other USB keys commercially supplied.

Shutter Management

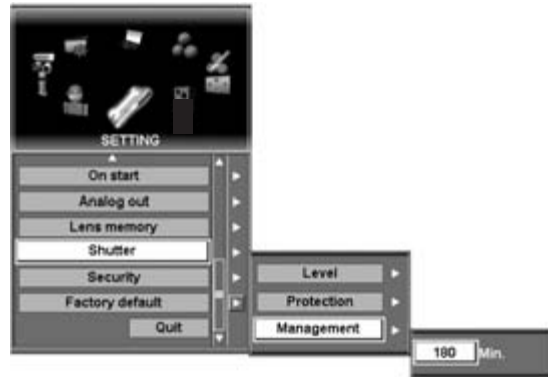

Select Management and set the timer between 5 and 180 minutes.

Key lock

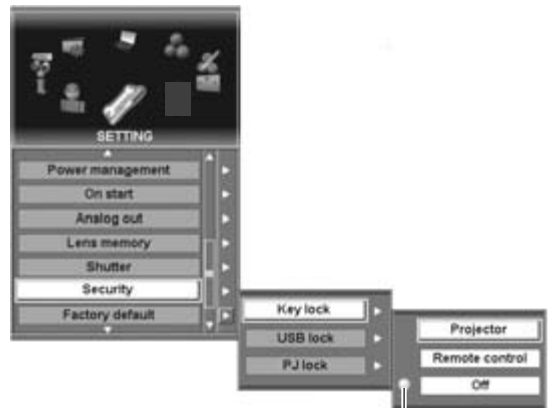

The setting selected.

USB lock

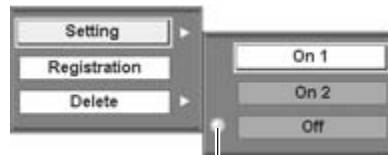

The setting selected.

PJ lock

This function prevents the projector from being operated by an unauthorized person and provides the following settings for security options.

- On1requires to enter the PIN code every time turning on the projector.
- On2requires to enter the PIN code to operate the projector once the power cord is disconnected; as long as the AC power cord is connected, the projector can be operated without the PIN code.
- Offthe projector is unlocked with the PIN code. To release PJ lock, select this setting.

Whenever to change the PIN code (the four-digit number), you are required to enter the PIN code. "1234" is set as the initial PIN code at the factory.

Enter a PJ PIN code

Select a number with using the Point buttons (▲, ▼, ◀, and ▶) or the Control pad and fix the number with the SELECT button. The number changes to "*" if you fixed a wrong number, move the pointer to "C" once with the Point buttons (▲, ▼, ◀, and ▶) or the Control pad to clear the number. Enter the correct number. Repeat this step to complete entering a four-digit number.

When the four-digit number is fixed, move to "Ent." Press the SELECT button so that you can change the following PIN code lock settings.

If you entered a wrong PIN code, the number (****) turns red and disappear. Enter a PIN code all over again.

To Change the PJ PIN Code setting

Select Off, On1, or On2 with the Point buttons (▲ and ▼) or the Control pad and then press the SELECT button.

To Change PJ PIN Code

The PIN code can be changed to your desired four-digit number. Select "PJ PIN code change" with the Point buttons (▲ and ▼) or the Control pad, and press the SELECT button. The PIN code input dialog box appears. Enter a current PIN code, and then a new PIN code as follows:

Select a number with the Point buttons (▲, ▼, ◀, and ▶) or the Control pad and fix the number with the SELECT button. Repeat it to complete entering a four-digit number. When the four-digit number is fixed, move the pointer to "Ent." Then press the SELECT button.

CAUTION:
WHEN YOU HAVE CHANGED PIN CODE, WRITE DOWN THE NEW PIN CODE IN COLUMN OF THE PIN CODE NO. MEMO ON PAGE 79, AND KEEP IT SECURELY. SHOULD THE PIN CODE BE LOST OR FORGOTTEN, THE PROJECTOR CAN NO LONGER BE OPERATED.

PJ lock



When the projector is locked with the PIN code, the PJ lock mark appears at top left of the Main menu.

Enter a PIN code



The input numbers change to "*" for security.

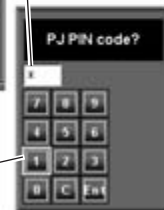

Pointer

Change the PJ Lock setting

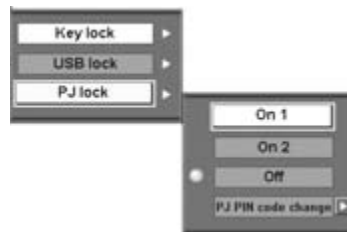

Select a desired setting with the Point buttons (▲ and ▼) or the Control pad and press the SELECT button.

Change the PIN code

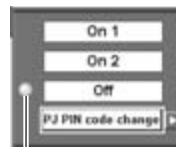

Select PJ PIN code change and press the SELECT button. The PIN code input dialog box appears.

The setting selected.

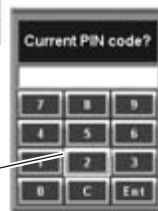

Pointer

Factory default

This function returns all setting values to the factory default settings except for those including: User logo, PJ PIN code, Logo PIN code, Security setting, Lamp time, Filter time, and PJ time.

Quit

Exits the Setting menu.

Factory default



Select Factory default and this box appears. Select [Yes], and the next box appears.

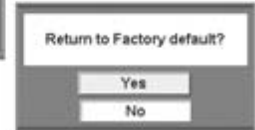

Select [Yes] to activate it.



Special

customizes control functions: Lamp, Fan control, Filter, Auto PC adj., Test pattern, RS-232C, and USB memory and displays Warning log.

- 1 Press the MENU button to display On-Screen Menu. Spin Menu icons with the Point buttons (▲, ▼, ◀, and ▶) or Control pad and press the SELECT button when the SPECIAL icon comes right in front.
- 2 Move the yellow frame pointer with the Point buttons (▲ and ▼) or Control pad to an item which you want to select and then press the SELECT button. The corresponding dialog box for the item appears.

Lamp

This feature displays the total time of the lamps being used. Select Lamp 1 or Lamp 2 to show each lamp wattage and time.

To reset the Lamp time, move the pointer to "Reset" and then press the SELECT button. The message "Lamp time reset?" is displayed. Move the pointer to [Yes] and then press the SELECT button.

✓ **Note:**

Be sure to reset the Lamp time only after replacing the lamp.

Fan control

This function provides you the following alternatives for the cooling fans operation of the projector and the Option box (Smoke Resist Box) separately provided. See page 73 for the Option box.

- Normal . . . normal operation
- Max faster operation than "Normal"

Select "Normal" for usual operation and "Max" to enhance the cooling effect.

✓ **Note:**

Setting of the cooling fans of the projector and the option box cannot be changed independently.

Filter

This feature displays total time of the filter on the projector and the Option box (Smoke Resist Box) being used.

To reset the Filter time, move the pointer to "Reset" and then press the SELECT button. A confirmation box appears. Move the pointer to [Yes] and then press the SELECT button.

✓ **Note:**

Option box cannot be selected when it is not mounted on the projector. For the information of the Smoke Resist Box, refer to Optional Parts on page 73 and contact the sales dealer or the service station.

Special Menu (Lamp)

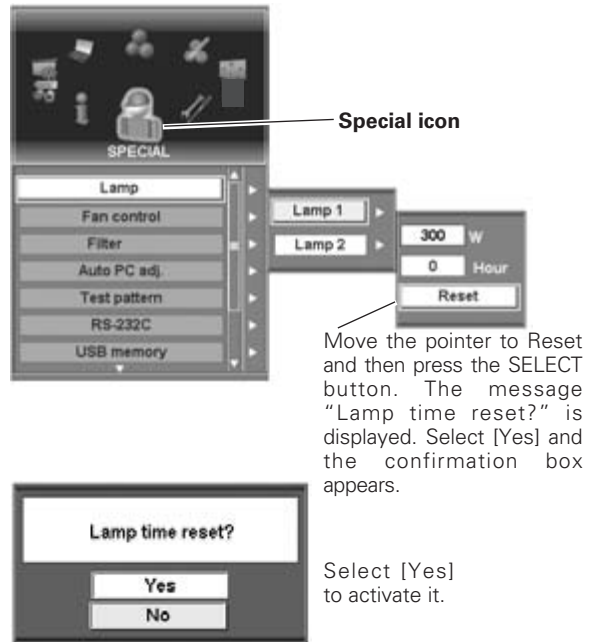

Fan control

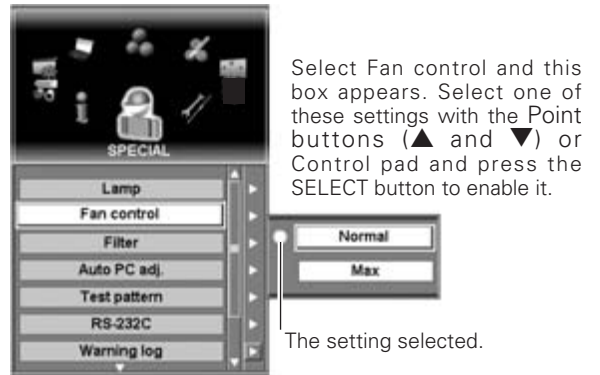

Filter

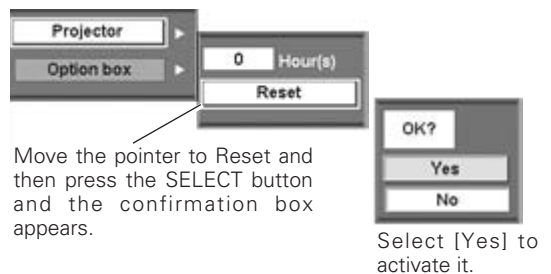

Auto PC adj.

Select "On" to enable the Auto PC adjust function and "Off" to disable it. Refer to page 30 and 40 for Auto PC adjust function.

Test pattern

Various test patterns are prepared in this projector allowing users to test the projection. Select one from the following twenty kinds of patterns: Cross 1 (W), Cross 2 (R), Cross 3 (G), Cross 4 (B), Cross 5 (M), Cross 6 (C), Cross 7 (Y), Gradation 1~4, Color, and Flat 1~8.

To cancel the Test pattern, press the CANCEL button on the top control or the remote control.

RS-232C

This feature allows users to set serial communication configuration (baud rate and the projector ID) when connecting several projectors via the RS-232C terminal of the projector. (p13, 78)

- Baud rate9600 / 19200
- Projector ID . . .001 ~ 999
- Defaultreturns Baud rate and Projector ID to factory default setting
(Baudrate: 19200, Projector ID: 001)

USB memory

This feature allows users to store PC mode and Image adjustment data on the optional USB key connected to the projector and recall it from the USB key. PC mode data and Image adjustment data can be stored separately on respective 10 memory areas of the USB key. (PC mode data: mode 1~50 x 10, Image adjustment data: Image 1-10 x 10) (p43, 47)

- Savestores the adjustment data on the USB key connected to the projector.
- Loadrecalls the stored data.
- Deletedeletes the stored data.

To use the USB memory function, the optional USB key (separately provided) is required. Refer to page 73 for the USB key information and contact the sales dealer or service station for purchasing. For further information on USB memory function, refer to the owner's manual that comes with the USB key.

- ✓ **Note:**
- USB memory function cannot be operated without our specified optional USB key. See page 73 for the optional parts.
 - USB memory cannot be displayed without the optional USB key connected to the projector. (p13)

Test pattern

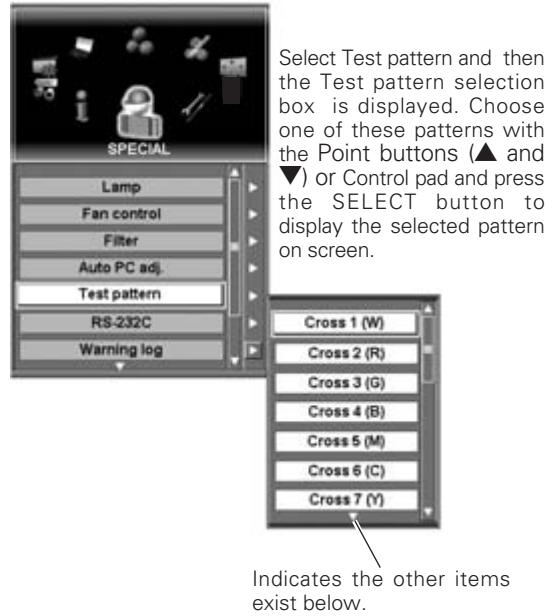

RS-232C

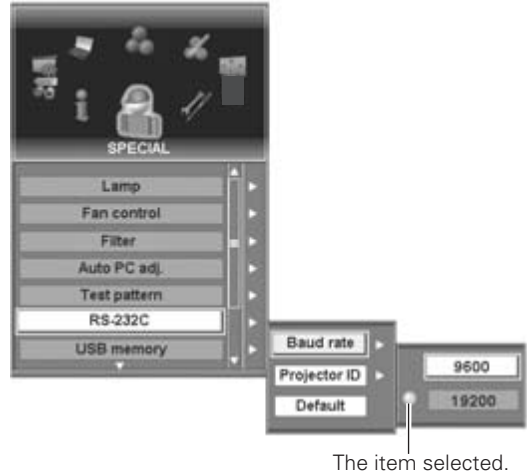

USB memory

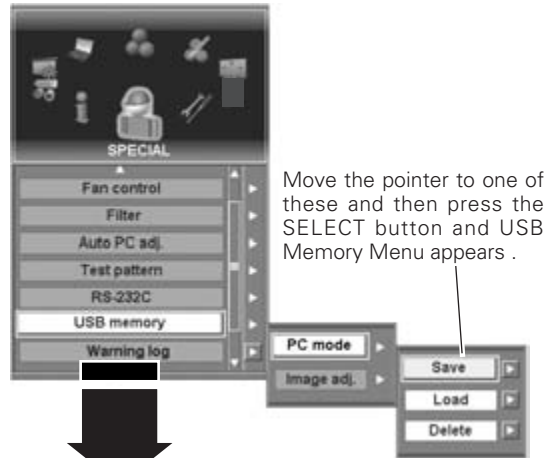

To be continued to the next page.

Warning log

Warning log shows the information of the past warning history of the projector. Up to 50 logs can be displayed. Log contents are as follows:

- Lamp-1 failure
- Lamp-2 failure
- Lamp-1 timeover
- Lamp-2 timeover
- Power failure
- Inside temp. A error
- Inside temp. B error
- Inside temp. C error
- External temp. error
- Power off (Power management)
- Power off (Shutter management)
- PJ filter timeover
- Option box filter timeover
- Option box error

Quit

Exits Warning log menu.

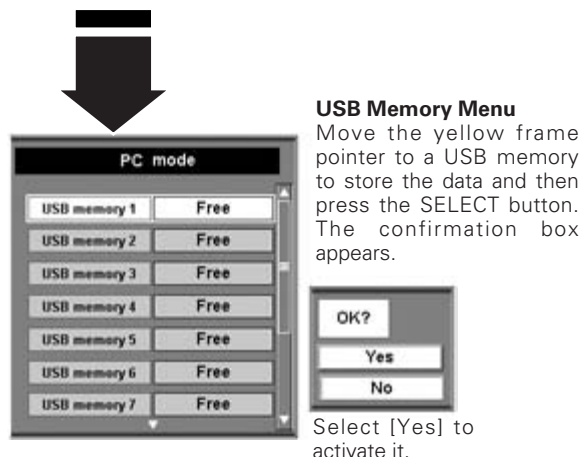

USB Memory Menu
Move the yellow frame pointer to a USB memory to store the data and then press the SELECT button. The confirmation box appears.

Select [Yes] to activate it.

Warning log



Exits the Warning log menu.



Information

displays current setting information: Input, System, Signal, Screen, Language, Lamp mode, Lamp status, Power management, Shutter management, Smoke resist, Option filter time, Security, and Remote control.

- 1 Press the MENU button to display On-Screen Menu. Spin Menu icons with the Point buttons (◀ and ▶) or Control pad and press the SELECT button when the INFORMATION icon comes right in front.
- 2 The Information window appears. The information window can also be displayed by pressing the INFORMATION button on the top control or the INFO button on the remote control.

Information

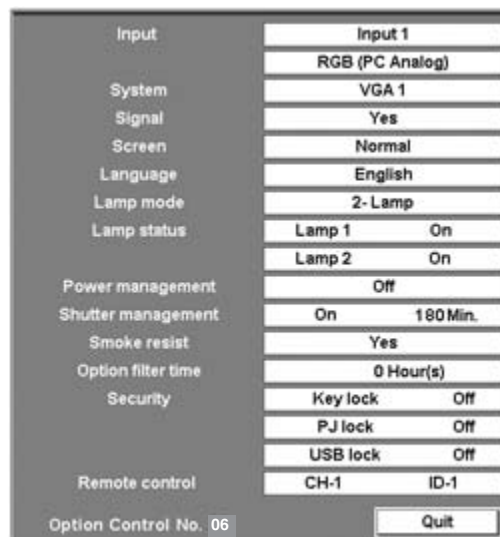

Input	Input 1
	RGB (PC Analog)
	VGA 1
System	Yes
Signal	Normal
Screen	English
Language	2-Lamp
Lamp mode	Lamp 1 On
Lamp status	Lamp 2 On
	Off
Power management	On 180 Min.
Shutter management	Yes
Smoke resist	0 Hour(s)
Option filter time	Key lock Off
Security	PJ lock Off
	USB lock Off
Remote control	CH-1 ID-1
Option Control No. 06	Quit

Maintenance and Cleaning

Warning Temp Indicator

The WARNING TEMP indicator shows the state of the function which protects the projector. Check the state of the WARNING TEMP indicator and the READY indicator to take proper maintenance.

The projector is shut down and WARNING TEMP indicator is blinking red.

The WARNING TEMP indicator slowly blinks red to let you know the internal temperature of the projector exceeds the normal level. If the temperature goes up further, the WARNING TEMP indicator turns fast blinking and then the projector will be turned off automatically. Then, the READY indicator will go out, but the WARNING TEMP indicator keeps blinking red. When the temperature inside the projector returns to normal, the READY indicator lights green and then the projector can be turned on. If the WARNING TEMP indicator still keeps blinking after the projector is turned on, check the followings;

✓ **Note:**

Even after the temperature inside the projector returns to normal, the WARNING TEMP indicator continues to blink and does not go out until the projector is turned on again.

Then check the matters below:

- Did you provide appropriate space for the projector to be ventilated? Check the installing condition to see if ventilation slots are not blocked.
- Is the projector not installed near the ventilation duct of air-conditioning equipment which may be hot? Install the projector away from the ventilation duct of air-conditioning equipment.
- Are the air filter clean? Check the air filter periodically. (p61)

If the WARNING TEMP indicator remains blinking after performing above checks, the cooling fans or the internal circuits may be malfunctioned. Contact the service station for check-up and repair.

All indicators except the LAMP indicator are blinking.

When the projector detects an abnormal condition, it is automatically shut down to protect the inside and all the Indicators except the LAMP indicator start blinking. In this case, disconnect the AC power cord and reconnect it, and then turn the projector on once again for check. If the projector cannot be turned on, disconnect the AC power cord and contact service station for check and repair.



CAUTION

DO NOT LEAVE THE PROJECTOR WITH THE AC POWER CORD CONNECTED UNDER THE ABNORMAL CONDITION. IT MAY RESULT IN FIRE OR ELECTRIC SHOCK.

TOP CONTROL

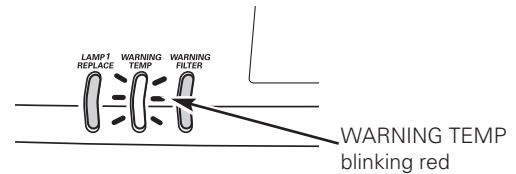

TOP CONTROL

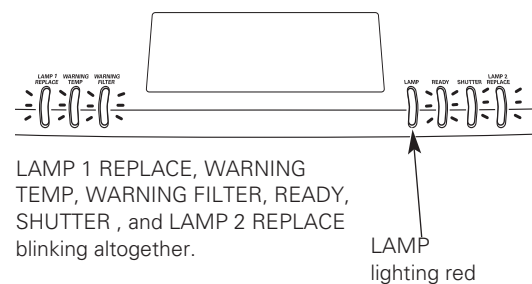

Air Filter Replacement

Air filters prevent dust from accumulating on the surface of the optical elements inside the projector. Should the air filters become clogged with dust particles, it will reduce cooling fans' effectiveness and may result in internal heat build up and adversely affect the life of the projector. Proper maintenance should be taken.

WARNING FILTER Indicator

This projector can monitor the filter condition. When the filter is clogged with dust and the performance is degraded, the WARNING FILTER indicator lights orange and let you know the filter replacement is required.

If the indicator is lighting orange, turn off the projector and replace the air filter immediately.

Using the projector with the WARNING FILTER indicator lighting may result in internal heat build up and cause damage to the optical elements inside the projector. The projector will shutdown automatically to protect itself when the projector's inside temperature is abnormally high.

TOP CONTROL

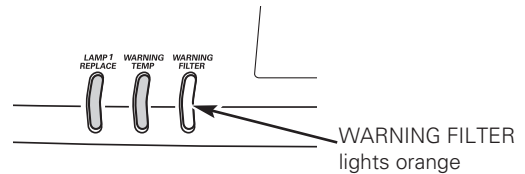

- 1** Turn off the projector, and disconnect the AC power cord from the AC outlet.
- 2** Pull down the tabs on both sides top of the filter cover and open the projector cover.
- 3** Pull out the air filter from the projector.
- 4** Replace the new air filter and the filter cover properly onto the projector.
- 5** **Reset the Filter time.** See "Filter" in the Special menu on page 57.



CAUTION

Do not operate a projector with Air Filter removed. Dust may accumulate on LCD Panel and Mirror degrading picture quality.

Do not put small parts into Air Intake Vents. It may result in malfunction of a projector.

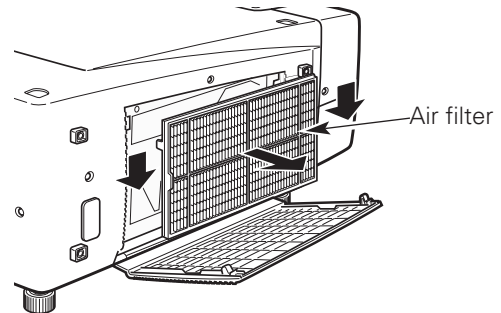
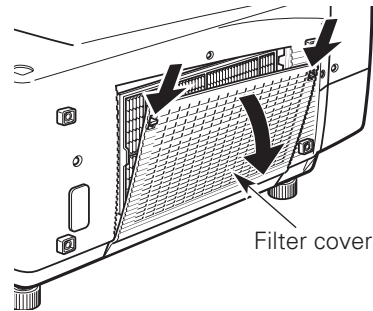

✓ **Note:**

- The projector cannot be operated with the air filter removed; it will shut down automatically if the air filter is removed while the projector is operating.
- Used in a place where the air pressure is relatively low such as highlands, the WARNING FILTER indicator may light orange even the air filter is clean.

RECOMMENDATION

We recommend avoiding dusty/smoky environments when operating a projector. Usage in these environments may cause poor image quality.

When using under dusty or smoky conditions, dust may accumulate on liquid crystal panel, lens, or optical elements inside it. This condition may degrade quality of projected image.

When above symptoms are noticed, contact your authorized dealer or service station for proper cleaning.

ORDER REPLACEMENT FILTER

When ordering the replacement air filter, give the following information to the dealer.

- **Model No. of your projector** : **LC-X6A/LC-SX6A**
- **Replacement Filter Part No.** : **610 315 1588**

Lamp Replacement

When the life of the projection lamps of this projector draw to an end, the LAMP 1 and 2 REPLACE indicators light orange. If one of these indicators lights orange, replace the lamp with a new one promptly.

CAUTION

For continued safety, replace with a lamp of the same type. Do not drop a lamp or touch a glass bulb! The glass can shatter and may cause injury.

Allow a projector to cool, for at least 45 minutes before you open the Lamp cover. The inside of the projector can become very hot.

Follow these steps to replace the lamp.

- 1** Turn off the projector and disconnect the AC plug. Allow the projector to cool for at least 45 minutes.
- 2** Loosen each screw on the lamp covers with a screwdriver, and remove the lamp covers.
- 3** Loosen two (2) screws of each lamp with a screwdriver and pull out one lamp and another with grasping the handle.
- 4** Replace each lamp with a new one and tighten the two (2) screws back into the positions. Make sure that the lamp is set properly. Replace the lamp covers and tighten the screws.
- 5** Connect the AC power cord to the projector and turn on the projector.
- 6** **Reset the Lamp time.**
See Lamp on page 57.

CAUTION :
DO NOT OPERATE A PROJECTOR WHILE ANY OF LAMPS IS REMOVED. IT MAY RESULT IN MALFUNCTIONS, FIRE HAZARD, OR OTHER ACCIDENTS.



NOTES ON LAMP REPLACEMENT:
TO MAINTAIN QUALITY OF PICTURE (BETTER BALANCE OF COLOR AND BRIGHTNESS IN THE ENTIRE SCREEN), WE RECOMMEND REPLACING ALL 2 LAMPS AT A TIME.

Top Control

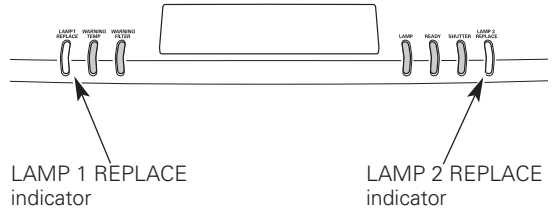

These indicators light orange when the life of the projection lamps draw to an end.

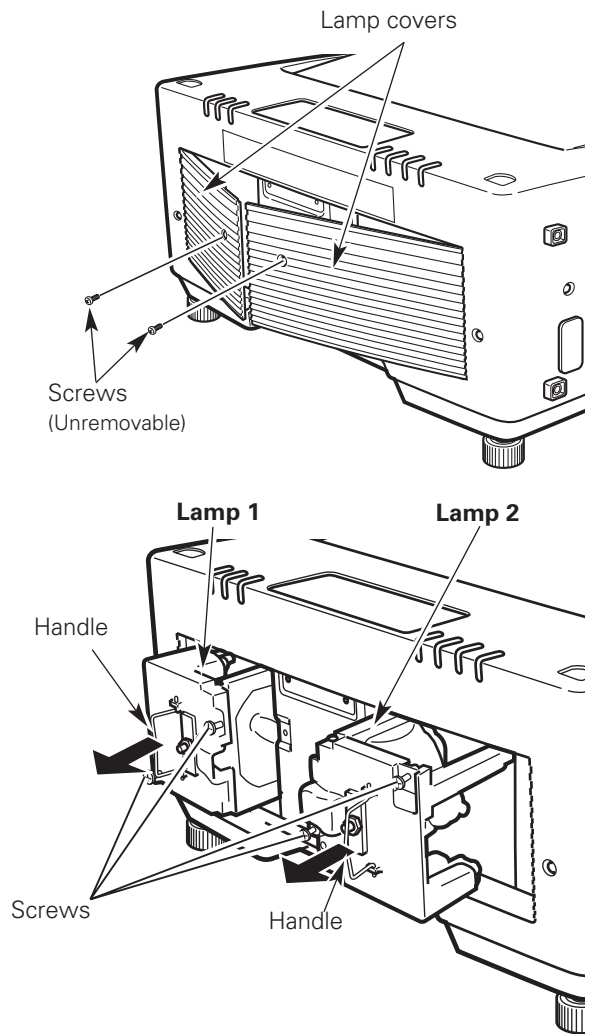

ORDER REPLACEMENT LAMP

Replacement Lamp can be ordered through your dealer. When ordering a Projection Lamp, give the following information to the dealer.

- **Model No. of your projector** : **LC-X6A/LC-SX6A**
- **Replacement Lamp Type No.** : **POA-LMP80**
(Service Parts No. 610 315 7689)

**LAMP HANDLING PRECAUTIONS**

This projector uses a high-pressure lamp which must be handled carefully and properly. Improper handling may result in accidents, injury, or create a fire hazard.

- Lamp lifetime may differ from lamp to lamp and according to the environment of use. There is no guarantee of the same lifetime for each lamp. Some lamps may fail or terminate their lifetime in a shorter period of time than other similar lamps.
- If the projector indicates that the lamp should be replaced, i.e., if the LAMP REPLACE INDICATOR lights up, replace the lamp with a new one IMMEDIATELY after the projector has cooled down.
(Follow carefully the instructions in the LAMP REPLACEMENT section of this manual.) Continuous use of the lamp with the LAMP REPLACE INDICATOR lighted may increase the risk of lamp explosion.
- A Lamp may explode as a result of vibration, shock or degradation as a result of hours of use as its lifetime draws to an end. Risk of explosion may differ according to the environment or conditions in which the projector and lamp are being used.

IF A LAMP EXPLODES, THE FOLLOWING SAFETY PRECAUTIONS SHOULD BE TAKEN.

If a lamp explodes, disconnect the projector's AC plug from the AC outlet immediately. Contact an authorized service station for a checkup of the unit and replacement of the lamp. Additionally, check carefully to ensure that there are no broken shards or pieces of glass around the projector or coming out from the cooling air circulation holes. Any broken shards found should be cleaned up carefully. No one should check the inside of the projector except those who are authorized trained technicians and who are familiar with projector service. Inappropriate attempts to service the unit by anyone, especially those who are not appropriately trained to do so, may result in an accident or injury caused by pieces of broken glass.

Cleaning the Projection Lens

Follow these steps to clean the projection lens.

- 1 Disconnect the AC power cord before cleaning.
- 2 Softly wipe the projection lens with a cleaning cloth that contains a small amount of non-abrasive camera lens cleaner, or use lens cleaning paper or a commercially available air blower to clean the lens. Avoid using an excessive amount of cleaner. Abrasive cleaners, solvents, or other harsh chemicals might scratch the surface of the lens.
- 3 When the projector is not in use, replace the lens cover.

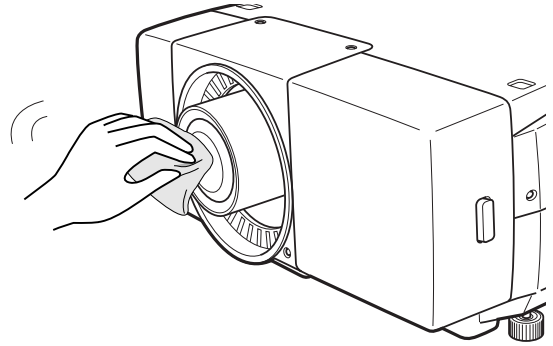

Cleaning the Projector Cabinet

Follow these steps to clean the projector cabinet.

- 1 Disconnect the AC power cord before cleaning.
- 2 Softly wipe the projector body with a soft, dry cleaning cloth. When it is heavily soiled, use a small amount of mild detergent and finish with a soft, dry cleaning cloth. Avoid using an excessive amount of cleaner. Abrasive cleaners, solvents, or other harsh chemicals might scratch the surface of the lens.
- 3 When the projector is not in use, put the projector in an appropriate carrying case to protect it from dust and scratches.

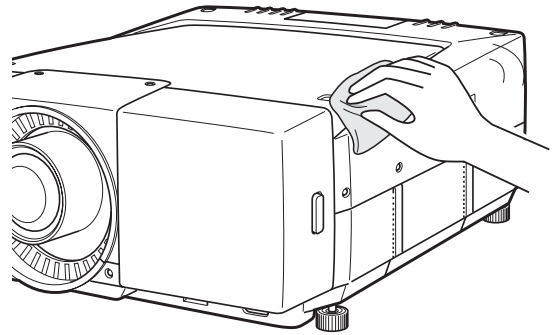

Attaching the Cord Cover Strap

When mounting the projector on the ceiling, connect the front cover to the projector with the provided cord cover strap to avoid the front cover from falling down.

- 1 Race the string through a hole on right edge of the projector's terminal area.
- 2 Fix the string to the hole inside the front cover with the screw.

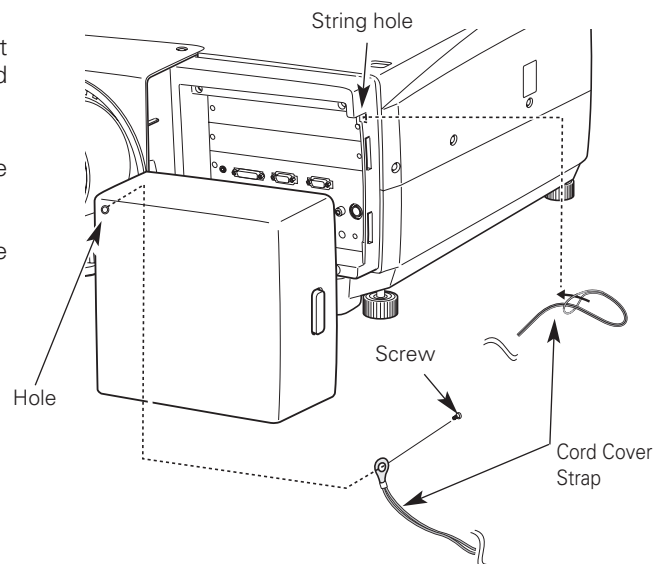

Indicators and Projector Condition















Main Indicators

Indicators			Projector Condition
READY Green	WARNING TEMP Red	LAMP Red	
			The projector is OFF. (The AC power cord is unplugged.)
			The projector is preparing for stand-by or the projection lamp is being cooled down. The projector cannot be turned on until cooling is completed.
			The projector is ready to be turned on with the POWER ON-OFF button.
			The projector is operating normally.
			The projector is in the Power management mode.
			The temperature inside the projector is abnormally high. The projector cannot be turned on. When the projector is cooled down enough and the temperature returns to normal, the LAMP indicator lights red and the projector can be turned on.
			The projector has been cooled down enough and the temperature returns to normal. When turning on the projector, the WARNING TEMP indicator stops blinking. Check and clean the air filters.
READY, WARNING TEMP, SHUTTER, WARNING FILTER, LAMP 1 REPLACE, AND LAMP 2 REPLACE indicators are blinking all together.			The projector detects an abnormal condition and cannot be turned on. Unplug the AC power cord and plug it again to turn on the projector. If the projector is turned off again, disconnect the AC power cord and contact the dealer or the service center for service and checkup. Do not leave the projector on. It may cause electric shock or a fire hazard.









LED Conditions:

















Shutter Indicator

Indicators			Projector Condition
READY Green	LAMP Red	SHUTTER Blue	
			The shutter is closed. (The projector is On.)
		 Slow	In the Shutter management mode. (The projector is in the stand-by mode.)
		 Slow	In the Shutter management mode. (The projector is in the cooling mode.)
		 Fast	The shutter is out of control. (The projector is in the stand-by mode.) In this case, contact the service station immediately.
			The shutter is out of control. (The projector is in the cooling mode.) In this case, contact the service station immediately.

Warning Filter Indicator

Indicators			Projector Condition
READY Green	LAMP Red	WARNING FILTER Orange	
		 Slow	The air filter is clogged with dust or has been used overtime.
			The air filter has been used overtime.
		 Fast	The air filter is not installed.

Lamp Replace Indicators

Indicators			Projector Condition
READY Green	LAMP Red	LAMP 1/2 REPLACE Orange	
		 Slow	The lamp cannot light up. (The projector is preparing for stand-by or the projection lamp is being cooled down. The projector cannot be turned on until cooling is completed.)
		 Slow	The lamp cannot light up. (The lamp has been cooled down enough and the projector is in stand-by mode and ready to be turned on with the POWER ON-OFF button.)
		 Fast	The lamp is not installed in the projector.
			The lamp of which indicator is lighting has been used overtime. Replace the lamp and then reset the Lamp time. The indicator will turn off.
		Both  Slow	Either lamp cover is not replaced or fit in. Both of the indicators keeps blinking three times at regular intervals and the projector cannot be turned on.

* When the LAMP 1 REPLACE indicator and the LAMP 2 REPLACE indicator light orange, replace the projection lamps with new ones promptly. And then reset the Lamp time after replacement of the lamps. See pages 57, 62, and 63.

Troubleshooting

Before calling your dealer or service center for assistance, check the items below once again.

- Make sure you have properly connected the projector to peripheral equipment as described on pages 22~24.
- Make sure all equipment is connected to AC outlet and the power is turned on.
- When you operate the projector with a computer and it does not project an image, restart the computer.

See Information by pressing the INFO. button to check the current projector condition before trying the solutions below.

Problem:	Solutions
No power	<ul style="list-style-type: none">– Plug the power cord of the projector into the AC outlet.– Make sure the Main On/Off switch is on.– See if the LAMP indicator lights red.– Wait 90 seconds after the projector is turned OFF when turning the projector back on. The projector can be turned on after the READY indicator turns green. (☞ “Turning Off the Projector” on page 28)– Check the WARNING TEMP. indicator. If the WARNING TEMP. indicator lights red, the projector cannot be turned on. (☞ “Warning Temp Indicator” on page 60)– Check the projection lamp. (☞ p. 62)– Unlock Key lock for the projector in the Setting Menu. (☞ p. 54)– Check if the air filter is fully installed and the filter cover is completely closed. (☞ p. 61)
Image is out of focus.	<ul style="list-style-type: none">– Adjust focus of the projector. (☞ p. 29)– Check the projection lens to see if it needs cleaning. (☞ p. 64)– Moving the projector from a cool to a warm place may result in moisture condensation on the projection lens. In such cases, leave the projector OFF and wait until condensation disappears.
No image	<ul style="list-style-type: none">– Check the connection between your computer or video equipment and the projector. (☞ p. 22~24)– See if the input signal is correctly output from your computer. Some laptop computers may need to change the setting for monitor output when connecting to a projector. See your computer’s instruction manual for the setting.– It takes about 20 seconds to display an image after turning on the projector.– See if the selected system is corresponding with your computer or video equipment. (☞ p. 38~39)– Select correct input source once again through menu operation. (☞ p. 36~37)– Make sure the temperature is not out of the specified Operating Temperature (5°C ~ 35°C).– Check if the shutter is closed. (☞ p. 29)
Image is dark.	<ul style="list-style-type: none">– Adjust Brightness and Contrast in the Image adjust menu. (☞ p. 44)– Check the Shutter level. (☞ p. 53)– Check each lamp condition and the LAMP 1/2 REPLACE indicators. (☞ p. 62, 67)
Image is Left/Right reversed. Image is Top/Bottom reversed.	<ul style="list-style-type: none">– Check the Ceiling / Rear item. (☞ “Screen Setting” on page 48.)– Check the Ceiling item. (☞ “Screen Setting” on page 48.)

Some displays are not seen during the Operation.	– Check the Display item. (☞ “Setting” on page 52)
Only part of image is displayed. (Large/Small)	– Check if you are in D. Zoom+/- mode. (☞ p. 32, 48) – Change Aspect setting in the Screen setting menu. (☞ p. 47) – Adjust Display area and Position in the PC adjust menu. (☞ p. 41–42)
PIN code dialog box appears at start-up.	– PJ PIN code lock is being set. Input a PIN code (1234 or numbers you have set). (☞ “Enter a PJ PIN Code” on pages 27 and 55)
Image is not displayed on the monitor connected to the ANALOG OUT terminal.	– Select Input 1 with the Input button on the top control or the INPUT 1 button on the remote control, or through the Input Menu. (☞ p. 30, 36) – Make sure Analog out is “On.” (☞ “Setting” on page 53)
The Top Control does not work.	– Check if the Keylock function is set. (☞ “Setting” on page 54)
The Wireless Remote Control does not work.	– Check the batteries. When replacing, the two batteries should be replaced at the same time. (☞ page 17) – Make sure no obstruction is between the projector and remote control. – Make sure you are not too far from the projector when using the remote control. Maximum operating range is 32.8’ (10m). – Make sure the ID and CH of the remote control is conformed to the projector. (☞ p. 16, 51) – Initialize the remote control ID and CH, and then initialize the remote control ID and CH of the projector as well. (☞ p. 16, 51) – Unlock Key lock for the remote control in the Setting Menu. (☞ p. 54) – Make sure the wired remote cable is not connected to the projector. (☞ p. 25) When all the solutions above fail, try Factory default in the Setting menu. (☞ p. 56)
USB mouse does not operate properly.	– Check cable connection of the USB mouse and the projector. (☞ p. 25)
SHUTTER button does not operate.	– Make sure Shutter protection is “Off.” (☞ “Setting” on page 53)
Lens position moves when Input is switched.	– Check Lens memory for each input. (☞ “Setting” on page 53)
Some operating menu items do not appear.	– Check the My menu setting. (☞ “Setting” on page 49)

WARNING :

High voltages are used to operate this projector. Do not attempt to open the cabinet.

If problems still persist after following all operating instructions, contact the dealer where you purchased the projector or the service center. Give the model number and explain about the problem. We will advise you how to obtain service.

Compatible Computer Specifications

Basically this projector can accept a signal from all computers with V- and H-Frequency mentioned below and less than 230 MHz of Dot Clock.

ON-SCREEN DISPLAY	RESOLUTION	H-Freq. (KHz)	V-Freq. (Hz)	ON-SCREEN DISPLAY	RESOLUTION	H-Freq. (KHz)	V-Freq. (Hz)
VGA 1	640 x 480	31.47	59.88	XGA15	1024 x 768	58.03	72.0
VGA 2	720 x 400	31.47	70.09	MAC 19	1024 x 768	60.24	75.08
VGA 3	640 x 400	31.47	70.09	MAC 21	1152 x 870	68.68	75.06
VGA 4	640 x 480	37.86	74.38	SXGA 1	1152 x 864	64.20	70.40
VGA 5	640 x 480	37.86	72.81	SXGA 2	1280 x 1024	62.50	58.60
VGA 6	640 x 480	37.50	75.00	SXGA 3	1280 x 1024	63.90	60.00
VGA 7	640 x 480	43.269	85.00	SXGA 4	1280 x 1024	63.34	59.98
MAC LC13	640 x 480	34.97	66.60	SXGA 5	1280 x 1024	63.74	60.01
MAC 13	640 x 480	35.00	66.67	SXGA 6	1280 x 1024	71.69	67.19
480i	(Interlace)	15.734	60.00	SXGA 7	1280 x 1024	81.13	76.107
575i	(Interlace)	15.625	50.00	SXGA 8	1280 x 1024	63.98	60.02
480p	(Progressive)	31.47	59.88	SXGA 9	1280 x 1024	79.976	75.025
575p	(Progressive)	31.25	50.00	SXGA 10	1280 x 960	60.00	60.00
SVGA 1	800 x 600	35.156	56.25	SXGA 11	1152 x 900	61.20	65.20
SVGA 2	800 x 600	37.88	60.32	SXGA 12	1152 x 900	71.40	75.60
SVGA 3	800 x 600	46.875	75.00	SXGA 13	1280 x 1024 (Interlace)	50.00	86.00
SVGA 4	800 x 600	53.674	85.06	SXGA 14	1280 x 1024 (Interlace)	50.00	94.00
SVGA 5	800 x 600	48.08	72.19	SXGA 15	1280 x 1024	63.37	60.01
SVGA 6	800 x 600	37.90	61.03	SXGA 16	1280 x 1024	76.97	72.00
SVGA 7	800 x 600	34.50	55.38	SXGA 17	1152 x 900	61.85	66.00
SVGA 8	800 x 600	38.00	60.51	SXGA 18	1280 x 1024 (Interlace)	46.43	86.70
SVGA 9	800 x 600	38.60	60.31	SXGA 19	1280 x 1024	63.79	60.18
SVGA 10	800 x 600	32.70	51.09	SXGA 20	1280 x 1024	91.146	85.024
SVGA 11	800 x 600	38.00	60.51	SXGA 21	1400 x 1050	63.90	60.00
MAC 16	832 x 624	49.72	74.55	MAC	1280 x 960	75.00	75.08
XGA 1	1024 x 768	48.36	60.00	MAC	1280 x 1024	80.00	75.08
XGA 2	1024 x 768	68.677	84.997	WXGA 1	1366 x 768	48.36	60.00
XGA 3	1024 x 768	60.023	75.03	WXGA 2	1360 x 768	47.70	60.00
XGA 4	1024 x 768	56.476	70.07	WXGA 3	1376 x 768	48.36	60.00
XGA 5	1024 x 768	60.31	74.92	WXGA 4	1360 x 768	56.16	72.00
XGA 6	1024 x 768	48.50	60.02	UXGA 1	1600 x 1200	75.00	60.00
XGA 7	1024 x 768	44.00	54.58	UXGA 2	1600 x 1200	81.25	65.00
XGA 8	1024 x 768	63.48	79.35	UXGA 3	1600 x 1200	87.50	70.00
XGA 9	1024 x 768 (Interlace)	36.00	87.17	UXGA 4	1600 x 1200	93.750	75.00
XGA 10	1024 x 768	62.04	77.07	720p	(Progressive)	45.00	60.00
XGA 11	1024 x 768	61.00	75.70	1035i	(Interlace)	33.75	60.00
XGA 12	1024 x 768 (Interlace)	35.522	86.96	1080i/60	(Interlace)	33.75	60.00
XGA 13	1024 x 768	46.90	58.20	1080i/50	(Interlace)	28.125	50.00
XGA 14	1024 x 768	47.00	58.30				

When a input signal is digital from DVI terminal, refer to chart below.

ON-SCREEN DISPLAY	RESOLUTION	H-Freq. (KHz)	V-Freq. (Hz)	ON-SCREEN DISPLAY	RESOLUTION	H-Freq. (KHz)	V-Freq. (Hz)
D-VGA	640 x 480	31.47	59.94	D-SXGA1	1280 x 1024	63.98	60.02
D-480p	720 x 480 (Progressive)	31.47	59.88	D-SXGA2	1280 x 1024	60.276	58.069
D-575p	768 x 575 (Progressive)	31.25	50.00	D-UXGA	1600 x 1200	75.00	60.00
D-SVGA	800 x 600	37.879	60.32	D-720p	1280 x 720 (Progressive)	45.00	60.00
D-XGA	1024 x 768	43.363	60.00	D-1035i	1920 x 1035 (Interlace)	33.75	60.00
D-WXGA1	1366 x 768	48.36	60.00	D-1080i/60	1920 x 1080 (Interlace)	33.75	60.00
D-WXGA2	1360 x 768	47.70	60.00	D-1080i/50	1920 x 1080 (Interlace)	28.125	50.00
D-WXGA3	1376 x 768	48.36	60.00				

Proper image may not be obtained in some signals. Specifications are subject to change without notice.

Technical Specifications

Mechanical Information

Projector Type	Multi-media Projector
Dimensions (W x H x D)	20.39" x 9.92" x 23.86" (518mm x 252mm x 606mm) (Not including adjustable feet)
Net Weight	52.9 lbs (24.0kg) Without lens
Feet Adjustment	0° to 3.65°

Panel Resolution

	LC-X6A	LC-SX6A
LCD Panel System	1.4" TFT Active Matrix type, 3 panels	
Panel Resolution	1024 x 768 dots	1400 x 1050 dots
Number of Pixels	2,359,296 (1024 x 768 x 3 panels)	4,410,000 (1400 x 1050 x 3 panels)

Signal Compatibility

Color System	PAL, SECAM, NTSC, NTSC4.43, PAL-M, and PAL-N
High Definition TV Signal	480i, 480p, 575i, 575p, 720p, 1035i, and 1080i
Scanning Frequency	H-sync. 15 ~ 120 KHz; V-sync. 48 ~ 120 Hz

Optical Information

Projection Image Size (Diagonal)	Subject to Optional lens
Projection Lens	Option
Throw Distance	Subject to Optional lens
Projection Lamp	300W

Interface

Input 1 terminals	DVI-D Terminal (Digital in) (HDCP Compatible) x1 and (VGA) HDB15 Terminal x 2 (Analog In/Analog Out)
Input 2 terminals	BNC Type x 5 (G/ VIDEO/Y, B/ Cb/Pb, R/ Cr/Pr, H/V, V)
Input 3 terminals	RCA Type x 3 (VIDEO/Y, Cb/Pb, Cr/Pr) and Mini DIN 4 pin x 1 (S-Video)
Other Terminals	
SERIAL PORT IN	DB9 pin x 1
SERIAL PORT OUT	DB9 pin x 1
USB Connectors	USB Series A receptacle x 1 and USB Series B receptacle x 1
R/C Jack	Mini Jack x 1

Power

Voltage and Power Consumption	AC 100 ~ 120 V (9.5 A Max. Ampere), 50/60 Hz (The U.S.A and Canada) AC 200 ~ 240 V (4.5 A Max. Ampere), 50/60 Hz (Continental Europe)
-------------------------------	--

Operating Environment

Operating Temperature	41 °F ~ 95 °F (5 °C ~ 35 °C)
Storage Temperature	14 °F ~ 140 °F (-10°C ~ 60 °C)

Remote Control

RF Remote Standard	2.4 GHz Low Power Radio
Frequency Band	2.472GHz (CH1: default setting), 2.403GHz (CH2), 2.446 GHz (CH3), and 2.421GHz (CH4)
Battery	AA or LR6 1.5V ALKALINE Type x 2
Operating Range	Within 32.8' (10m)
Dimensions	2.0" x 1.2" x 7.1" (50mm x 30mm x 181mm)
Net Weight	0.33 lbs (150 g) (including batteries)

Accessories

Owner's Manual
 AC Power Cord
 Remote Control and Batteries
 VGA Cable
 Lens Attachment (2 types)
 Light Block Plates (2 types)
 Real Color Manager Pro (CD-ROM)
 Cord Cover Strap
 Security Label (PIN Code/USB Key)

- The specifications are subject to change without notice.
- LCD panels are manufactured to the highest possible standards. Even though 99.99% of the pixels are effective, a tiny fraction of the pixels (0.01% or less) may be ineffective by the characteristics of the LCD panels.
- The On-Screen Menu and figures in this manual may differ slightly from the product.

Optional Parts

The parts listed below are optionally available. When ordering those parts, give the item name, Model No., and Option Control No. (if necessary) to the sales dealer.

	<i>Model No.</i>
SCART-VGA Cable	: AH-98881 <i>(This cable is used for RGB Scart 21-Pin Video output of video equipment.)</i>
Projector USB Key	: EUB-100
Smoke Resist Box	: AH-69601
Wired Remote Cable (30m)	: POA-CA-RC30
<i>Optional Interface Board</i>	<i>Model No.</i>
Advanced Network	: AH-72143
Dual SDI	: AH-72162
DVI (HDCP compatible)	: AH-72003
D-Sub	: AH-72031
Warp & Blending	: AH-72181
5-BNC	: AH-72015

Menu Tree



INPUT

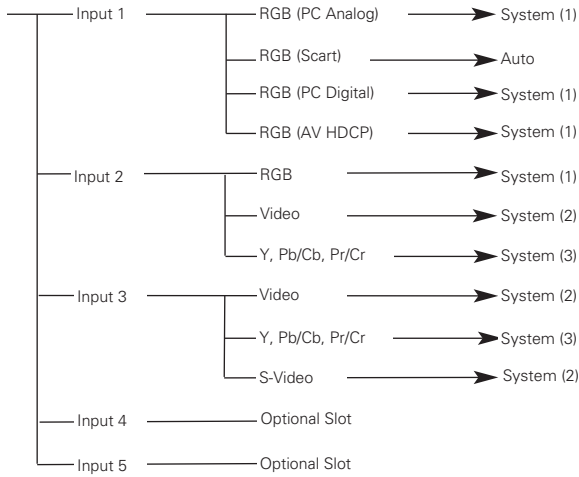

SYSTEM

(1)

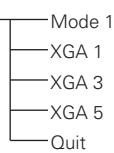

SYSTEM

(2)

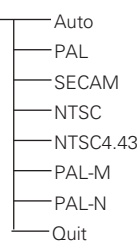

SYSTEM

(3)

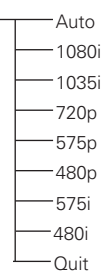

*Systems displayed in the System Menu vary depending on an input signal.



SCREEN SETTING

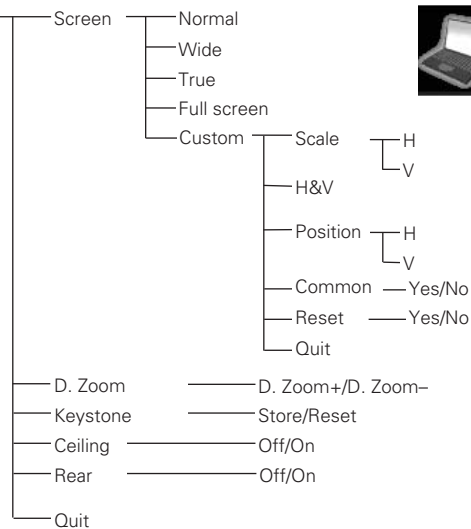

PC ADJ.

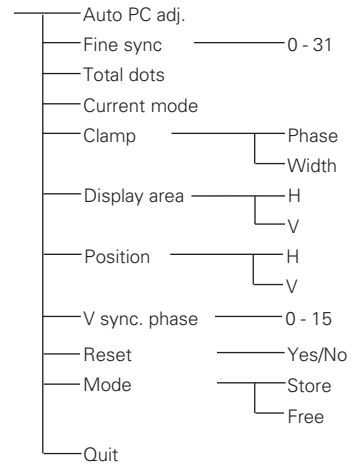



IMAGE

- Standard (AV)
- Cinema
- Standard (PC)
- Real
- Image 1
- Image 2
- Image 3
- Image 4
- Image 5
- Image 6
- Image 7
- Image 8
- Image 9
- Image 10
- Quit



SETTING

- Language
 - English
 - German
 - French
 - Italian
 - Spanish
 - Portuguese
 - Dutch
 - Swedish
 - Russian
 - Chinese
 - Korean
 - Japanese
- Menu
 - Position
 - My menu
 - Simple menu — Off/On
- Logo
 - Logo select
 - Default
 - My logo
 - Off
 - Capture — Yes/No
 - Lock — Off/On
 - PIN code change
- Background
 - Blue
 - My logo
 - Black
- Lamp
 - Control
 - Normal
 - Auto
 - Eco
 - Mode
 - 2-Lamp
 - 1-Lamp
 - Auto
 - Lamp1
 - Lamp2
- Remote control code
 - CH 1- 4
 - ID 1- 8
- Display — Off/On
- Input search — Off/On
- Power management
 - Off/Ready/Shut down
 - 1 ~ 60 minutes
- On start — Off/On
- Analog out — Off/On
- Lens memory — Input 1-5
 - Off
 - Memory
- Shutter
 - Level
 - Normal
 - High contrast
 - Protection
 - Remote control
 - Projector
 - Management — 5 ~ 180 minutes
- Security
 - Key lock
 - Projector
 - Remote control
 - Off
 - USB Lock
 - Setting
 - On 1
 - On 2
 - Off
 - Registration
 - Delete
 - The USB plugged in
 - The other USB
 - PJ lock
 - On 1
 - On 2
 - Off
 - PJ PIN code change
- Factory default — Yes/No
- Quit



IMAGE ADJ.

- Contrast — 0 - 63
- Brightness — 0 - 63
- Color — 0 - 63
- Tint — 0 - 63
- Color management
 - Color
 - Gamma
 - List
 - All Del
 - Menu
 - Color. M
 - Color. M
 - Menu
- Auto picture control
 - Off
 - L1
 - L2
- Color temp.
 - XLow
 - Low
 - Mid
 - High
- Red — 0 - 63
- Green — 0 - 63
- Blue — 0 - 63
- Sharpness — 0 - 15
- Gamma — 0 - 15
- Noise reduction
 - Off
 - L1
 - L2
- Progressive — Off/On
- Film — Off/On
- Reset — Yes/No
- Store
 - Image 1
 - Image 2
 - Image 3
 - Image 4
 - Image 5
 - Image 6
 - Image 7
 - Image 8
 - Image 9
 - Image 10
- Quit



INFORMATION

- Input
- System
- Signal
- Screen
- Language
- Lamp mode
- Lamp status
- Power management
- Shutter management
- Smoke resist
 - Option filter time
- Security
- Remote control
- Quit



SPECIAL

- Lamp
 - Lamp 1
 - W
 - Hour(s)
 - Reset — Yes/No
 - Lamp 2
 - W
 - Hour(s)
 - Reset — Yes/No
- Fan control
 - Normal
 - Max
- Filter
 - Projector
 - Hour(s)
 - Reset — Yes/No
 - Option box
 - Hour(s)
 - Reset — Yes/No
- Auto PC adj. — Off/On
- Test pattern
 - Cross 1 (W)
 - Cross 2 (R)
 - Cross 3 (G)
 - Cross 4 (B)
 - Cross 5 (M)
 - Cross 6 (C)
 - Cross 7 (Y)
 - Gradation 1~4
 - Color
 - Flat 1~8
- RS-232C
 - Baud rate
 - 9600
 - 19200
 - Projector ID — 001 – 999
 - Default — Yes/No
- USB memory
 - PC mode
 - Save — USB memory 1~10
 - Quit
 - Load — USB memory 1~10
 - Quit
 - Delete — USB memory 1~10
 - Quit
 - Image adj.
 - Save — USB memory 1~10
 - Quit
 - Load — USB memory 1~10
 - Quit
 - Delete — USB memory 1~10
 - Quit
- Warning log
- Quit

Dimensions

Unit : inch (mm)

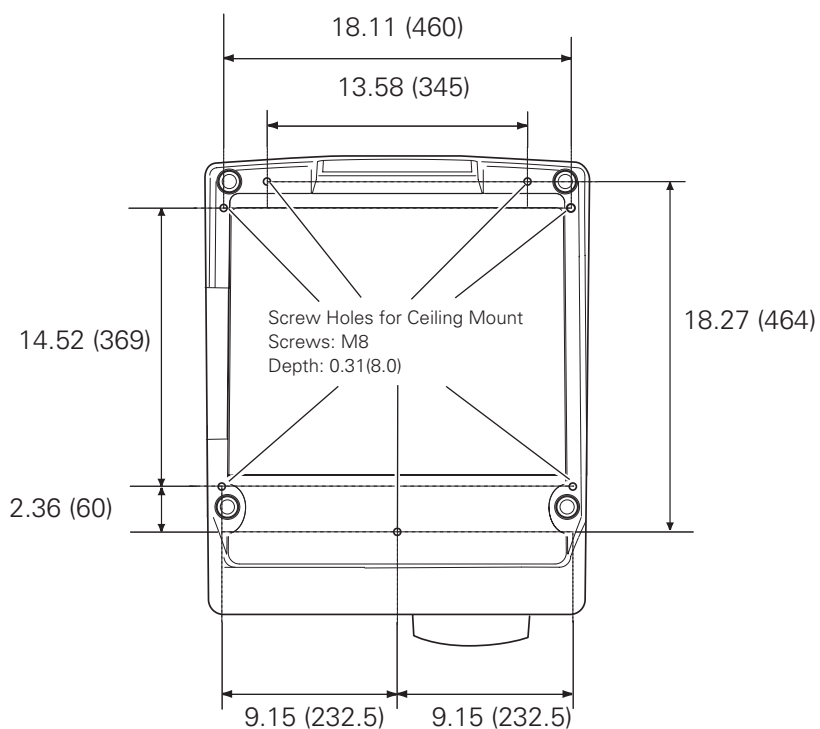
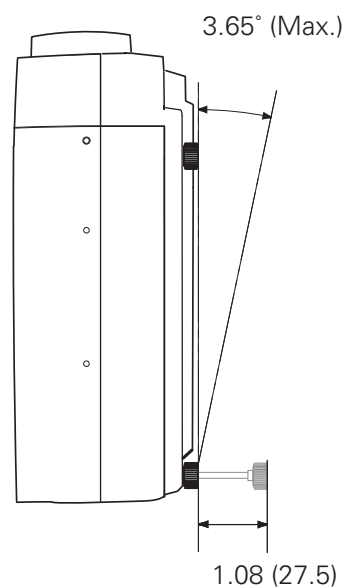
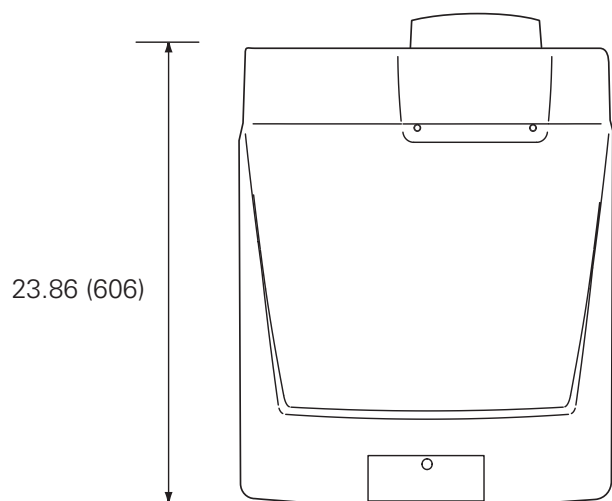
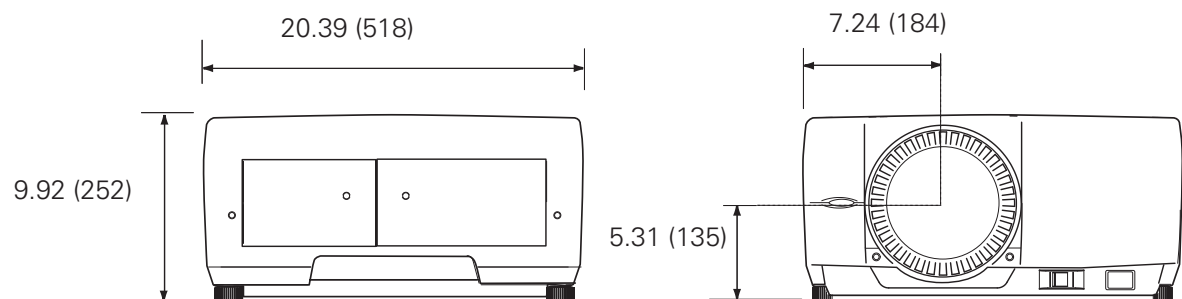

Terminal Configurations

ANALOG INPUT / OUTPUT TERMINAL (ANALOG)

Terminal: HDB15-PIN

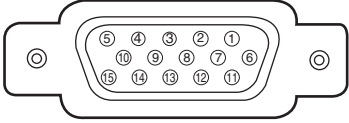

1	Red (R/Cr) Input / Output	9	----
2	Green (G/Y) Input / Output	10	Ground (Vert.sync.)
3	Blue (B/Cb) Input / Output	11	Ground / ----
4	----	12	----
5	Ground (Horiz.sync.)	13	Horiz. sync. Input/Output (Composite H/V sync.)
6	Ground (Red)	14	Vert. sync.
7	Ground (Green)	15	----
8	Ground (Blue)		

DVI-D TERMINAL (DIGITAL)

Terminal: DVI-D

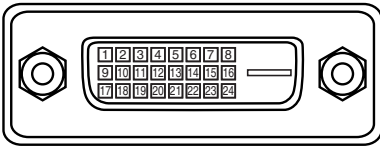

1	T.M.D.S. Data2-	9	T.M.D.S. Data1-	17	T.M.D.S. Data0-
2	T.M.D.S. Data2+	10	T.M.D.S. Data1+	18	T.M.D.S. Data0+
3	T.M.D.S. Data2 Shield	11	T.M.D.S. Data1 Shield	19	T.M.D.S. Data0 Shield
4	No Connect	12	No Connect	20	No Connect
5	No Connect	13	No Connect	21	No Connect
6	DDC Clock	14	+5V Power	22	T.M.D.S. Clock Shield
7	DDC Data	15	Ground (for +5V)	23	T.M.D.S. Clock+
8	No Connect	16	Hot Plug Detect	24	T.M.D.S. Clock-

SERIAL PORT IN /OUT TERMINAL

Terminal: DIB 9-PIN

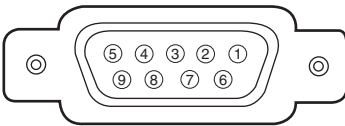

	Serial
1	----
2	R X D
3	T X D
4	----
5	GND
6	----
7	----
8	----
9	----

USB CONNECTOR (Series B)

Series B

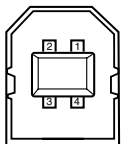

1	Vcc
2	- Data
3	+ Data
4	Ground

PIN Code Number Memo

Write down the PIN code number in the column below and keep it with this manual securely. If you forgot or lost the number and unable to operate the projector, contact the service station.

PIN Code Lock No.

--	--	--	--

Factory default set No: 1 2 3 4*

Logo PIN Code Lock No.

--	--	--	--

Factory default set No: 4 3 2 1*

*Should the four-digit number be changed, the factory set number will be invalid.

While the projector is locked with the PIN code or USB key...

Put the appropriate label (supplied) on in a prominent place of the projector's body while it is locked with a PIN code or USB key.

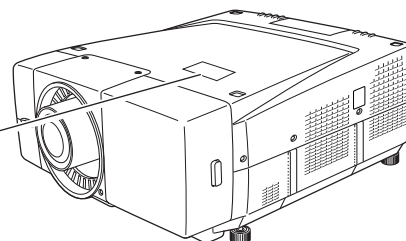
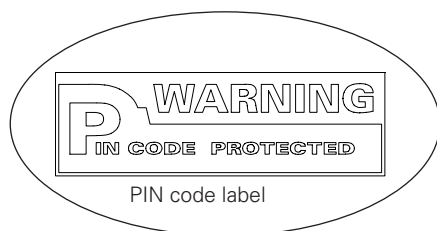

Pixelworks ICs used.



The CE Mark is a Directive conformity mark of the European Community (EC).



This symbol on the nameplate means the product is Listed by Underwriters Laboratories Inc. It is designed and manufactured to meet rigid U.L. safety standards against risk of fire, casualty and electrical hazards.

Index**Numerics**

- 2:2 Pulldown 46
- 2:3 Pulldown 46

A

- AC plug type 20
- AC Power Cord 8, 20
- Accessories 73
- Adjustable Feet 9, 19
- Analog out 53
- Appendix 68
- Aspect setting 47
- Auto PC Adjust 40
- Auto PC Adjustment 30
- Auto picture control 45
- AV System 39

B

- Baud rate 58
- Brightness 44

C

- Capture 50
- Carrying Handle 7, 9
- Ceiling 48
- Ceiling Mount 77
- Cinema 43
- Cleaning 64
- Color 44
- Color Management 44
- Color Management List 45
- Color Selection 44
- Color System 72
- Color temp. 45
- Compatible Computer Specifications 70
- COMPONENT 39
- Connecting to Computer 22
- Connecting to Video Equipment 23, 24
- Contrast 44
- Control Pad 2, 14
- Cord Cover Strap 64

D

- D-Zoom 26, 32, 48
- Dimensions 72, 77
- Display 52
- Dual SDI 73
- DVI-D 12,, 78

F

- Factory default 56
- Fan control 57
- Faroudja 73

- Federal Communication Commission Notice 8
- Film 2, 46
- Filter 57, 61
- Filter Indicator 66
- Focus 26, 29
- Freeze 31
- Front cover 21
- Full screen 47

G

- Gamma 46

H

- H&V 47
- Handling the Projector 7
- HDB15-PIN 78

I

- Image 43
- Image Adjust 44
- Indicators 10, 65
- Information 30, 59
- Input 30, 36
- Input Search 52
- Installation 18
- Interface 72
- Interface Board 21

K

- Keylock 54
- Keystone 26, 31, 48

L

- Lamp 51, 57
- Lamp Control 51
- Lamp Mode 51
- Lamp Replace Indicator 67
- Lamp Replacement 62
- Language 50
- Lens Installation 18
- Lens memory 53
- Lens Shift 2, 19, 26, 29
- Logo 50
- Logo Lock 50
- Logo PINcode 50
- Logo Select 50

M

- Manual PC Adjust 41
- Menu 49
- Menu Icons 35
- Menu Position 49
- Menu Tree 74
- Mouse Operation 25, 33

Moving the Projector	.7	Shutter Indicator	.66
My Menu	.2	Shutter level	.53
My menu	.49	Shutter Management	.54
N		Shutter protection	.53
Network Manager	.73	Simple menu	.49
Noise reduction	.46	Smoke Resist Box	.73
Normal	.47	Special	.57
O		Specifications	.72
On start	.52	T	
On-Screen Menu	.33, 34, 35	Telecine	.45
Option Control No.	.21, 73	Terminal Configurations	.78
Optional Parts	.73	Terminals	.12, 21
P		Test pattern	.58
P-Timer	.31	Top Control	.9, 11
Panel Resolution	.72	Troubleshooting	.68
Parts Name	.9	True	.47
PC Adjustment	.40	Turning Off the Projector	.28
PC System	.38	Turning On the Projector	.27
PIN code	.27, 55, 79	U	
PJ lock	.55	USB CONNECTOR	.78
Position	.47	USB Key	.73
Positioning	.6, 18	USB lock	.54
Power management	.52	USB memory	.58
Progressive	.46	W	
Projector Condition	.65	Warning log	.59
Projector ID	.58	WARNING TEMP indicator	.10, 60
R		Wide	.47
Radio Wave	.17	Wired Remote Control	.16, 25
READY indicator	.10	Z	
Real	.43	Zoom	.26, 29
Rear	.48		
Reference Buttons	.26		
Remote Control	.14, 16, 72		
Remote control	.51		
Remote Control Battery Installation	.17		
Remote Control Channel and ID	.16		
REPLACEMENT LAMP	.61, 63		
RESET	.13		
RS-232C	.58		
S			
Scale	.47		
Scanning Frequency	.72		
Screen	.31, 47		
Security	.54		
SERIAL PORT	.13, 78		
Setting	.49		
Shutter	.2, 29, 53		
SHUTTER indicator	.10		

EIKI

A-key to better communications

U.S.A.

EIKI International, Inc.
30251 Esperanza
Rancho Santa Margarita
CA 92688-2132
U.S.A.
Tel : 800-242-3454 (949)-457-0200
Fax : 800-457-3454 (949)-457-7878
E-Mail : usa@eiki.com

Deutschland & Österreich

EIKI Deutschland GmbH
Am Frauwald 12
65510 Idstein
Deutschland
Tel : 06126-9371-0
Fax : 06126-9371-14
E-Mail : info@eiki.de

Canada

EIKI CANADA - Eiki International, Inc.
P.O. Box 156, 310 First St. - Unit 2,
Midland, ON, L4R 4K8, Canada
Tel : 800-563-3454 (705)-527-4084
Fax : 800-567-4069 (705)-527-4087
E-Mail : canada@eiki.com

Eastern Europe

EIKI CZECH spol. s.r.o.
Umělecká 15
170 00 Praha 7
Czech Republic
Tel : +42 02 20570024
+42 02 20571413
Fax : +42 02 20571411
E-Mail : easterneurope@eiki.de

Japan & Worldwide

EIKI Industrial Company Limited.
4-12 Banzai-Cho, Kita-Ku, Osaka,
530-0028 Japan
Tel : +81-6-6311-9479
Fax : +81-6-6311-8486
E-Mail : japan@eiki.com

WorldWide Website <http://www.eiki.com>