

EIKI

OWNER'S MANUAL

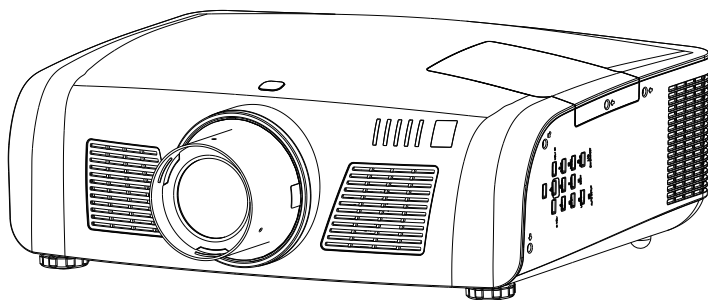

LC-XN200

LC-WXN200

LC-XN200L*

LC-WXN200L*

*Projection lens is optional.

Features and Design

This Projector is designed with the most advanced technology for portability, durability, and ease of use. This projector utilizes built-in multimedia features, a palette of 16.77 million colors, and matrix liquid crystal display (LCD) technology.

Simple Computer System Setting

The projector has the Multi-scan system to conform to almost all computer output signals quickly. Up to WUXGA resolution can be accepted.

Useful Functions for Presentations

The digital zoom function allows you to focus on the crucial information during a presentation.

Lamp Control

Brightness of the projection lamp can be selected.

Logo Function

The Logo function allows you to customize the screen logo.

Multilanguage Menu Display

The screen menu of the projector is available in 20 languages: Traditional Chinese, Simple Chinese, English, French, Spanish, Portuguese, German, Italian, Japanese, Korean, Russian, Finnish, Dutch, Thai, Vietnam, Turkish, Africans, Indonesian, Farsi and Arabian.

Helpful Maintenance Functions

Lamp and filter maintenance functions provide for better and proper maintenance of the projector.

Security Function

The Security function helps you to ensure security of the projector. With the Key lock function, you can lock the operation on the side control or remote control. PIN code lock function prevents unauthorized use of the projector.

LAN Network Function

This projector is loaded with the wired and wireless LAN network function. You can operate and manage the projector via network. (Pages 75-91.)

Auto Setup Function

This function enables input source search, auto pc adjust and auto focus by simple pressing the AUTO button on the remote control.

Colorboard Function

At the time of simple projection on the colored wall, you can get the close color image to the color image projected on a white screen by selecting the similar color to the wall color from the preset four colors.

Switchable Interface Terminal

The projector provides a switchable interface terminal. You can use the terminal as computer input or monitor output conveniently.

Power Management

The Power management function reduces power consumption and maintains the lamp life.

Closed Caption

This is a printed version of the program sound or other information displayed on the screen. You can turn on the feature and switch the channels.

✓ *Note:*

- The screen menu and images in the manual may slightly differ from the real product.
- The manual is subject to change without prior notice.

Contents

Features and Design	2	Computer input	33
Contents	3	Input select(Digital:HDMI/DVI/Network/	
Safety Instruction	4	Image Viewer/USB Autorun)	34
Air circulation	6	Computer system select	36
Installing the projector properly	6	Auto PC adjustment	37
Moving the projector	7	Manual adjustment via PC	38
Compliance	8	Image Select	39
Accessories	9	Image adjust	40
Part names and functions	10	Screen size adjust	41
Front	10	Input select (Component, S-video, Video)	
Back	10		43
Bottom	10	Video input	43
Rear Terminals	11	Video system select	44
Side control panel	12	Image Select	45
Indicators	12	Image adjust	46
Remote Control	13	Screen size adjust	47
Install remote control batteries	15	Setting	48
Remote Control Operating range	15	Setting	48
Remote Control Code	15	Information	57
Installation	16	Maintenance and cleaning	58
Positioning the projector	16	WARNING TEMP indicator	58
Adjustable feet	16	Cleaning the air filter	59
Lens installation	17	Resetting the filter counter	59
Lens shift adjustment	18	Replacement Filter Type	59
Connecting to computer(Digital and analog RGB)	19	Lens cover	60
Connecting to video equipment (Video, S-Video)	20	Clean the projector lens	60
Connecting to USB device (USB-A, USB-B)	21	Clean the cabinet	60
		Replace the lamp	61
Connecting to audio equipment	22	Resetting the Lamp Counter	62
Connecting the AC power cord	23	Replacement Lamp Type	63
Basic operation	24	Appendix	64
Turn on the projector	24	Troubleshooting	64
Turn off the projector	25	Indicator and projector state	66
How to operate the on-screen menu	26	Compatible computer specifications	67
Menu bar	27	Menu Tree	68
Auto setup	28	Technical Specifications	71
Lens shift adjustment	28	Configurations of terminals	73
Zoom adjust	28	Content of hazardous substances and elements	74
Focus adjust	28	Dimensions	74
Keystone correction	29	PIN code memorandum	75
Sound adjust	30	Network Control Instructions	76
Remote control operation	31	Wireless LAN control [ProjectorMe]	79
Input select(Analog:VGA IN 1/VGA IN 2/RGBHV)	33	ZIGBEE Networking Instructions	86
		ZIGBEE Networking	86



Safety Instruction

Please read this manual completely before installing and operating the projector.

The projector provides many convenient features and functions. Proper operation may enable you to fully utilize the features and keep it in good condition. Otherwise, it will not only shorten the service life of the unit, but also may cause malfunction, a fire, or other accidents.

If your projector cannot work properly, please read this manual again, check the operating methods and cable connection, and try the solutions in the part of Troubleshooting. If the problem still exists, contact the dealer or the service center.

The lamp of the projector is a wearing part. The luminance may decrease after a period of operation and be weaker than that of a new lamp. This is normal. Please strictly follow the steps in Turning on the unit and Turning off the unit to turn on/off the projector, and the requirements in Maintaining and cleaning the projector to service and clean the projector regularly. Otherwise the high temperature residual heat may not radiate, greatly shorten the service life of the projector and lamp, or even damage them within a short period.

 Caution ELECTRIC SHOCK DO NOT OPEN 
<p>CAUTION: TO REDUCE THE RISK OF ELECTRIC SHOCK, DO NOT REMOVE COVER (OR BACK). NO USER SERVICEABLE PARTS INSIDE EXCEPT LAMP REPLACEMENT. REFER SERVICING TO QUALIFIED SERVICE PERSONNEL.</p>
<p>THIS SYMBOL INDICATES THAT DANGEROUS VOLTAGE CONSTITUTING A RISK OF ELECTRIC SHOCK IS PRESENT WITHIN THIS UNIT.</p>
<p>THIS SYMBOL INDICATES THAT THERE ARE IMPORTANT OPERATING AND MAINTENANCE INSTRUCTIONS IN THE OWNER'S MANUAL WITH THIS UNIT.</p>
<p>FOR EU USERS The symbol mark and recycling systems described below apply to EU countries and do not apply to countries in other areas of the world. Your product is designed and manufactured with high quality materials and components which can be recycled and/or reused. The symbol mark means that electrical and electronic equipment, batteries and accumulators, at their end-of-life, should be disposed of separately from your household waste. Note: If a chemical symbol is printed beneath the symbol mark, this chemical symbol means that the battery or accumulator contains a heavy metal at a certain concentration. This will be indicated as follows: Hg: mercury, Cd: cadmium, Pb: lead In the European Union there are separate collection systems for used electrical and electronic equipment, batteries and accumulators. Please, dispose of them correctly at your local community waste collection/recycling centre. Please help us to conserve the environment we live in!</p>



Safety precautions

- Caution:**
- The projector must be grounded.
 - Do not expose the projector to raindrops or high humidity to avoid a fire or electric shock.
- This projector produces intense light from the projection lens. Avoid staring directly into the lens, otherwise eye damage could be caused. Be especially careful that children do not stare directly into the beam.
 - Place the projector in a proper position. Otherwise it may result in fire hazard.
 - Leave an appropriate space from the top, sides, and back of the shell in order to ventilate and cool down the projector. The figures below indicate the minimum distance to be left. It must be satisfied if the projector is placed in sealed environment like a cabinet.

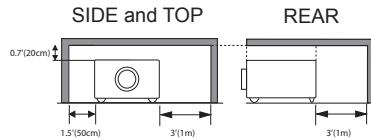

- Do not cover the vent of the projector. Poor radiation may shorten the service life or even cause dangers.
- Remove the AC power plug if the projector is not to be used for a long time.
- Do not project the same image for a long time; otherwise, a residual image may appear on the LCD panel due to its characteristic.



Caution

Do not set the projector in greasy, wet, or smoky conditions such as in a kitchen, to prevent a malfunction or accident. If the projector comes in contact with oil or chemicals, it may become deteriorated.

Read and keep this manual for future reference.

The mains plug/appliance coupler is used as disconnect device, the disconnect device shall remain readily operable.

Safety Instruction

All the safety and operating instructions should be read before the product is operated.

Read all of the instructions given here and retain them for later use. Unplug this projector from AC power supply before cleaning. Do not use liquid or aerosol cleaners. Use a damp cloth for cleaning.

Follow all warnings and instructions marked on the projector.

For added protection to the projector during a lightning storm, or when it is left unattended and unused for long periods of time, unplug it from the wall outlet. This will prevent damage due to lightning and power line surges.

Do not expose this unit to rain or use near water... for example, in a wet basement, near a swimming pool, etc...

Do not use attachments not recommended by the manufacturer as they may cause hazards.

Do not place this projector on an unstable cart, stand, or table. The projector may fall, causing serious injury to a child or adult, and serious damage to the projector.

Use only with a cart or stand recommended by the manufacturer, or sold with the projector. Wall or shelf mounting should follow the manufacturer's instructions, and should use a mounting kit approved by the manufacturers.

An appliance and cart combination should be moved with care. Quick stops, excessive force, and uneven surfaces may cause the appliance and cart combination to overturn.



Slots and openings in the back and bottom of the cabinet are provided for ventilation, to ensure reliable operation of the equipment and to protect it from overheating.

The openings should never be covered with cloth or other materials, and the bottom opening should not be blocked by placing the projector on a bed, sofa, rug, or other similar surface. This projector should never be placed near or over a radiator or heat register.

This projector should not be placed in a built-in installation such as a book case unless proper ventilation is provided.

Never push objects of any kind into this projector through cabinet slots as they may touch dangerous voltage points or short out parts that could result in a fire or electric shock. Never spill liquid of any kind on the projector.

Do not install the projector near the ventilation duct of air-conditioning equipment.

This projector should be operated only from the type of power source indicated on the marking label. If you are not sure of the type of power supplied, consult your authorized dealer or local power company.

Do not overload wall outlets and extension cords as this can result in fire or electric shock. Do not allow anything to rest on the power cord. Do not locate this projector where the cord may be damaged by persons walking on it.

Do not attempt to service this projector yourself as opening or removing Covers may expose you to dangerous voltage or other hazards. Refer all servicing to qualified service personnel.

Unplug this projector from wall outlet and refer servicing to qualified service personnel under the following conditions:

- When the power cord or plug is damaged or frayed.
- If liquid has been spilled into the projector.
- If the projector has been exposed to rain or water.
- If the projector does not operate normally by following the operating instructions. Adjust only those controls that are covered by the operating instructions as improper adjustment of other controls may result in damage and will often require extensive work by a qualified technician to restore the projector to normal operation.
- If the projector has been dropped or the cabinet has been damaged.
- When the projector exhibits a distinct change in performance, this indicates a need for service.

When replacement parts are required, be sure the service technician has used replacement parts specified by the manufacturer that have the same characteristics as the original part. Unauthorized substitutions may result in fire, electric shock, or injury to persons.

Upon completion of any service or repairs to this projector, ask the service technician to perform routine safety checks to determine that the projector is in safe operating condition.

Information for users in the European Union

This is a device to project images onto a screen, etc., and is not intended for use as indoor lighting in a domestic environment. Directive 2009/125/EC.

NOTE FOR CUSTOMERS IN THE US

Ⓜ LAMP(S) INSIDE THIS PRODUCT CONTAIN MERCURY AND MUST BE RECYCLED OR DISPOSED OF ACCORDING TO LOCAL STATE OR FEDERAL LAWS.

Safety Instruction

Air circulation

Vents in the cabinet are provided for ventilation. To ensure reliable operation of the product and to protect it from overheating, these openings must not be blocked or covered.



Caution

Hot air is exhausted from the exhaust vent. When using or installing the projector, the following precautions should be taken.

- Do not put any flammable objects or spray can near the projector. Hot air is exhausted from the air vents.
- Keep the exhaust vent at least 1 meter away from any objects.
- Do not touch a peripheral part of the exhaust vent, especially screws and metallic part. This area will become hot while the projector is being used.
- Do not put anything on the projector. Objects put on the cabinet will not only get damaged but also may cause fire hazard by heat. Cooling fans are provided to cool down the projector. The fan's running speed is changed according to the temperature inside the projector.

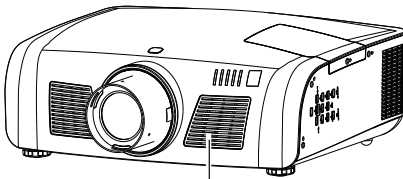

Air Intake Vent

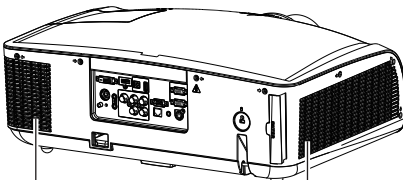

Exhaust Vent

Air Intake Vent

Installing the projector properly

Be sure to use the projector properly in the specified position. Improper positioning may reduce the lamp lifetime, and even cause grave accidents or a fire hazard. The projector can project images upwards, downwards or slantwise in the direction vertical to a horizontal surface. When slantwise installing the projector downwards, make sure its bottom upturned.

√ Note: To turn over an image, please set the function of Ceiling On.

Notes on Projector Positioning During installation, avoid the project positioning manners as described below.

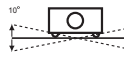
 Do not roll the projector over 10 degrees from side to side.



Do not put the projector on either side to project an image.



Caution in ceiling installation the projector

- Only qualified personal is authorized for ceiling installation.
- We are not responsible for the hurt and damage caused by ceiling bracket that purchased from unauthorized dealer even in warranty period.
- Remove the ceiling bracket immediately while not use.
- While installing, torque screwdriver is suggested, don't use electric or impact-type screwdriver.

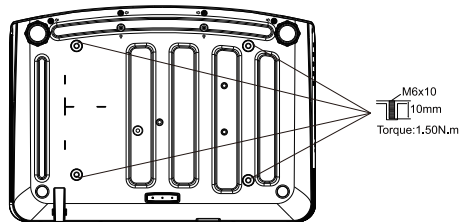

Moving the projector

When moving the projector, cover the lens cap and retract the adjustable feet to prevent damage to the lens and cabinet. Put it into a carton with the lens facing upwards if the projector is not in use for a long period.

Notes on Lens Protective Ring

Before operating the projector, remove the lens protective ring. In case of transportation, press LENS SHIFT button on the side control or on the remote control for over 5 seconds to let the lens back to its central position and put on the lens protective ring to protect the lens.

Lens Protective Ring

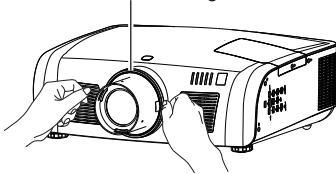

Note:



The lens of the projector is electric. When operating the projector, pay attention to the following conditions.



- When the lens is rotating, do not touch it, otherwise your fingers may get hurt.
- People who are not familiar with the projector must not touch the lens.



Caution in moving or transporting the projector

- Do not drop or bump the projector, otherwise damages or malfunctions may result.
- When carrying the projector, use a suitable carrying case.
- Do not transport the projector by courier or any other transport service in an unsuitable transport case. This may cause damage to the projector. For information about transporting the projector by courier or any other transport service, consult your dealer.
- Do not put the projector in a case before it is cooled enough.

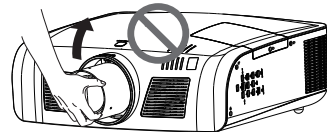

Do not hold the lens and the peripheral part.

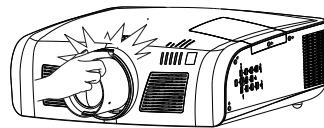

Notes on Projector Handling

When lifting or moving the projector, do not hold the lens and the peripheral part to prevent damage on the lens or projector.

Be careful in handling the projector. Do not drop or bump it to avoid strong force, or place other objects on the cabinet.

Compliance

FCC Caution

Note: This equipment has been tested and found to comply with the limits for a Class B digital device, pursuant to Part 15 of the FCC Rules. These limits are designed to provide reasonable protection against harmful interference in a residential installation. This equipment generates, uses, and can radiate radio frequency energy, and if not installed and used in accordance with the instructions, may cause harmful interference to radio communications. However, there is no guarantee that interference will not occur in a particular installation. If this equipment does cause harmful interference to radio or television reception, which can be determined by turning the equipment off and on, the user is encouraged to try to correct the interference by one or more of the following measures:

- Reorient or relocate the receiving antenna.
- Increase the separation between the equipment and receiver.
- Connect the equipment into an outlet on a circuit different from that to which the receiver is connected.
- Consult the dealer or an experienced radio/TV technician for help.

Use of shielded cable is required to comply with class B limits in Subpart B of Part 15 of FCC Rules.

Do not make any changes or modifications to the equipment unless otherwise specified in the instructions. If such changes or modifications should be made, you could be required to stop operation of the equipment.

Model Number : LC-XN200, LC-WXN200,LC-XN200L,LC-WXN200L

Trade Name : EIKI

Responsible party : EIKI International, Inc.

Address : 30251 Esperanza Rancho Santa Margarita CA 92688-2132

Telephone No. : 800-242-3454 (949-457-0200)

AC Power Cord Requirement

The AC Power Cord supplied with this projector meets the requirement for use in the country you purchased it.

AC Power Cord for the United States and Canada:

AC Power Cord used in the United States and Canada is listed by the Underwriters Laboratories (UL) and certified by the Canadian Standard Association (CSA).

AC Power Cord has a grounding-type AC line plug. This is a safety feature to be sure that the plug will fit into the power outlet. Do not try to defeat this safety feature. Should you be unable to insert the plug into the outlet, contact your electrician.

AC Power Cord for the United Kingdom:

This cord is already fitted with a moulded plug incorporating a fuse, the value of which is indicated on the pin face of the plug. Should the fuse need to be replaced, an ASTA approved BS 1362 fuse must be used of the same rating, marked thus \diamond . If the fuse cover is detachable, never use the plug with the cover omitted. If a replacement fuse cover is required, ensure it is of the same colour as that visible on the pin face of the plug (i.e. red or orange). Fuse covers are available from the Parts Department indicated in your User Instructions.

If the plug supplied is not suitable for your socket outlet, it should be cut off and destroyed.

The end of the flexible cord should be suitably prepared and the correct plug fitted.

WARNING : A PLUG WITH BARED FLEXIBLE CORD IS HAZARDOUS IF ENGAGED IN A LIVE SOCKET OUTLET.

The Wires in this mains lead are coloured in accordance with the following code:

Green-and-yellow Earth
Blue Neutral
Brown Live

As the colours of the wires in the mains lead of this apparatus may not correspond with the coloured markings identifying the terminals in your plug proceed as follows:

The wire which is coloured green-and-yellow must be connected to the terminal in the plug which is marked by the letter E or by the safety earth symbol \perp or coloured green or green-and-yellow.





The wire which is coloured blue must be connected to the terminal which is marked with the letter N or coloured black.

The wire which is coloured brown must be connected to the terminal which is marked with the letter L or coloured red.

WARNING: THIS APPARATUS MUST BE EARTHED.

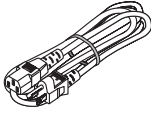
THE SOCKET-OUTLET SHOULD BE INSTALLED NEAR THE EQUIPMENT AND EASILY ACCESSIBLE.

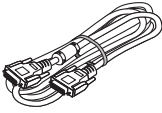
Accessories

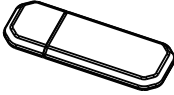
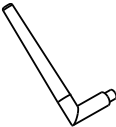
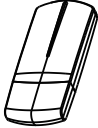
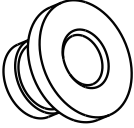
<p>Owner's Manual(CD)</p> 	<p>AC Power cord</p>  <p>US Type x1 Euro Type x1</p>	<p>Remote control with batteries (AA or LR6)</p> 
<p>VGA cable</p> 	<p>Quick start guide</p> 	<p>Rubber Cap</p> 
<p>WiFi Dongle</p> 	<p>Zigbee Antenna</p> 	<p>Zigbee Dongle</p> 
<p>Rubber gasket</p> 		

Part names and functions

Front

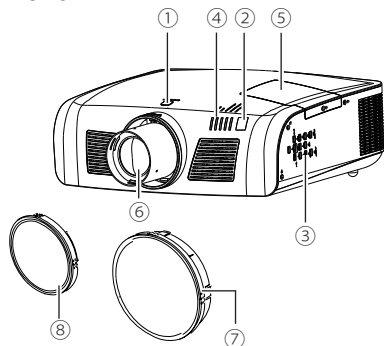

- ① Lens release button
- ② Remote control receiver
- ③ Control panel
- ④ Indicators
- ⑤ Lamp cover
- ⑥ Projection lens
- ⑦ Dust cap
(Prevent the internal element from dust when projector lens is not installed)
- ⑧ Lens cover

Back

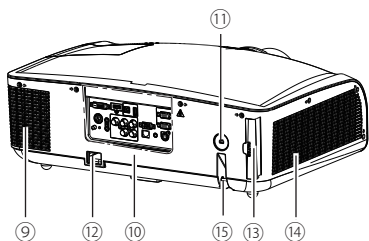

- ⑨ Exhaust vent



Note:

Hot air is exhausted from the exhaust vent. Do not put heat-sensitive objects near this side.

- ⑩ Rear terminals
- ⑪ Anti-theft slot
- ⑫ Power cord connector
- ⑬ Filter
- ⑭ Air intake vent
- ⑮ Anti-theft bar

Bottom

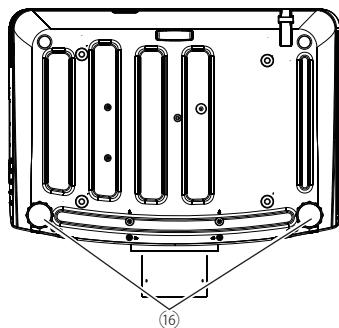

- ⑯ Adjustable feet

Rear Terminals

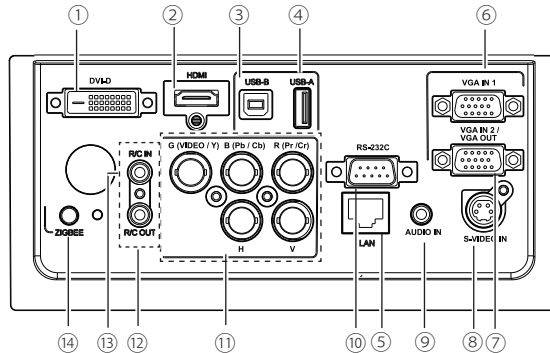

- ① **DVI-D**
Connect the DVI digital output signal to this terminal.
- ② **HDMI**
Connect digital output signal from HDMI to this terminal.
- ③ **USB-B**
Connect one end of B type USB cable to this terminal and the other end to a computer to project the computer screen.
- ④ **USB-A**
- Connect A type USB device (e.g. USB flash drive) to this terminal (Support FAT File System).
- WiFi dongle to this terminal.
- ⑤ **LAN**
When using wired network to control and operate the projector, connect the wired network cable to this terminal.
- ⑥ **VGA IN 1**
Connect output from the source signal from computer to this terminal.
- ⑦ **VGA IN 2/VGA OUT**
- Connect output signal from computer to this terminal.
- Output the signal from ⑥ to other monitor.
- ⑧ **S-VIDEO IN**
Connect S-Video signal to this jack.
- ⑨ **AUDIO IN**
Connect the audio signal output to this jack.
- ⑩ **RS-232C**
When using RS-232C serial commands to control or operate the projector, connect the serial cable to this terminal.
Set "Standby mode" in "Setting" menu as "Normal" and set "Zigbee mode" in "Zigbee setting" in "Network" menu as "OFF".
- ⑪ **R(Pr/Cr)/G(VIDEO/Y)/B(Pb/Cb)/H/V**
- Connect RGBHV (5BNC) signal to R, G, B, H and V jacks respectively.
- Connect composite video signal from video device to G(VIDEO/Y) terminal.
- Connect component signal to Y,Pb/Cb,Pr/Cr.
- ⑫ **R/C OUT**
When using this output port, the output is completed by connecting the wired remote control cable to the wired remote control input port of another device.
- ⑬ **R/C IN**
When using wired remote control, connect the wired remote control cable to this port. The wireless remote control is disabled after inserting the wired remote control cable to either the remote control or R/C in terminal.
- ⑭ **ZIGBEE**
Transmit wireless short-distance signal. Please insert the rubber gasket (supplied) into this jack to prevent static electricity when the ZIGBEE function is not used. When using the ZIGBEE function, Please insert the Zigbee antenna.

Part names and functions

Side control panel

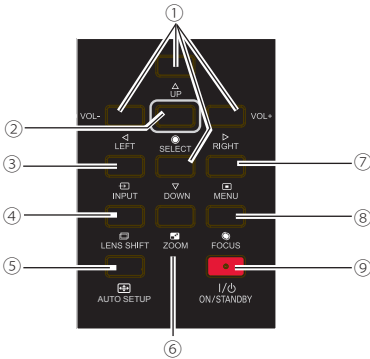

Indicators

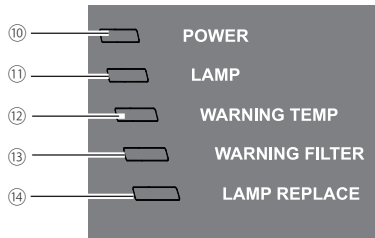

① UP/DOWN/LEFT(VOL-)/RIGHT(VOL+)

- Select item or adjust data in screen menu.
- Select the image display area in digital zoom + mode.
- Adjust the volume.

② SELECT

- Enter screen menu or execute selected items.

③ INPUT

- Select an input source.

④ LENS SHIFT

- Enter lens shift mode.

⑤ AUTO SETUP

- Perform various settings configured automatically.

⑥ ZOOM

- Enter zoom adjust mode.

⑦ MENU

- Open or close the screen menu.

⑧ FOCUS

- Enter focus adjust mode.

⑨ ON/STAND-BY

- Turn on or off the projector.

⑩ POWER

- Lights red when the projector is in stand-by mode.
- Lights green during operations.
- Flashes green when the projector is in power management mode (stand-by).

⑪ LAMP

- Lights green during operations.

⑫ WARNING TEMP

- Flashes red when the internal temperature of the projector is beyond the operating temperature range.(Page 58,66)

⑬ WARNING FILTER

- Lights red when the service life of the filter is over. You should replace it with a new one immediately.(Page 59)

⑭ LAMP REPLACE

- Lights yellow when the service life of the lamp is over. You should clean it with a new one immediately.(Page 61)

Remote Control

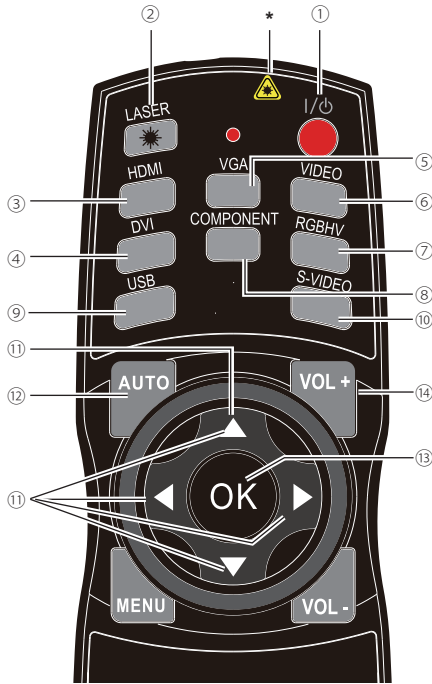

*Laser Transmitting Window:
Laser beam will emit from this window. While pressing LASER button during the projection to use the remote control as a laser pointer.

Do not stare directly at the laser transmitting window or aim the window at human body, to avoid any physical injury.

- ① POWER
Turn on or turn off the projector.
- ② LASER
Press this button during projection, the remote control can be used as a laser pointer.
- ③ HDMI
Select "HDMI" as input source.
- ④ DVI
Select "DVI" as input source.
- ⑤ VGA
Select "VGA IN 1" or "VGA IN 2" as input source.
-VGA IN 2 can not be selected when using the VGA IN 2/ VGA OUT terminal as MONITOR OUT output."
- Press VGA button directly to switch VGA IN 1 or VGA IN 2.
- ⑥ VIDEO
Select "Video" as input source.
- ⑦ RGBHV
Select "RGBHV" as input source.
- ⑧ COMPONENT
Select "Component" as input source.
- ⑨ USB
Select Image Viewer as input source. Press this button again to select USB Autorun.
Every time pressing this button, input source becomes as follows:
Image Viewer
- USB Autorun
- Image Viewer
- ⑩ S-VIDEO
Select "S-video" as input source.
- ⑪ ▲▼▶◀
- Select item or adjust data in screen menu.
- Select the image display area in digital zoom + mode.
- ⑫ AUTO
Enter auto setup adjust mode.
- ⑬ OK
Enter the menu or select an item in the menu.
- ⑭ VOL+
Increase the volume level.

Part names and functions

Remote Control

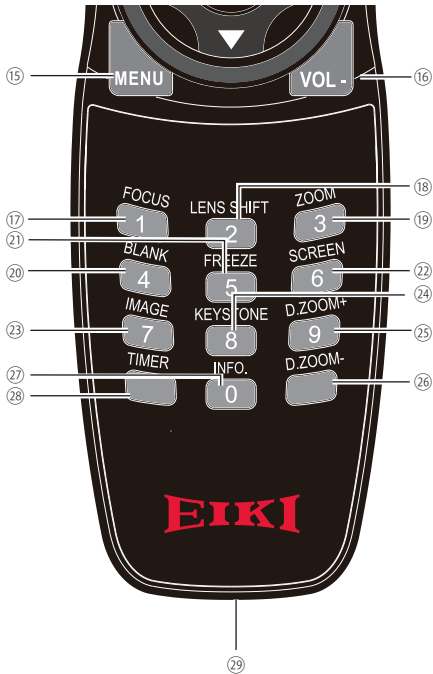

- ⑮ MENU
Open or close the screen menu.
- ⑯ VOL-
Decrease the volume level.
- ⑰ FOCUS
Enter focus adjust mode.
- ⑱ LENS SHIFT
Enter lens shift mode.
(Press and hold LENS SHIFT button on remote control for over 5 seconds to move the lens back to central position).
- ⑲ ZOOM
Enter image size adjust mode.
- ⑳ BLANK
Temporarily close the image on the screen.
- ㉑ FREEZE
Freeze the project image.
- ㉒ SCREEN
Select screen mode.
- ㉓ IMAGE
Select image mode.
- ㉔ KEYSTONE
Correct the H/V Keystone distortion.
Every time pressing this button, the mode becomes as follows:
Keystone
- H/V Keystone
- Corner
- ㉕ D.ZOOM+
Select the digital zoom + mode.
- ㉖ D.ZOOM-
Select the digital zoom - mode.
- ㉗ INFO.
Display current status information of the projector.
- ㉘ TIMER
Enable the timer function.
- ㉙ Wired remote control output port
Connect the wired remote control cable to this port while operating the projector by wired remote control.

Install remote control batteries

① Open the battery compartment lid.

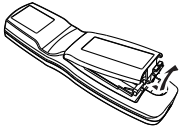

② Install new batteries into the compartment.

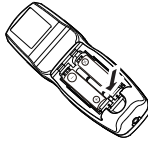

Two AA batteries
For correct polarity (+ and -), be sure battery terminals are in contact with pins in the compartment.

③ Replace the compartment lid.

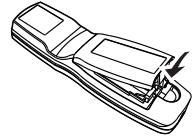

To ensure safe operation, please observe the following precautions:

- Use two (2) AA or LR6 type batteries.
- Always replace batteries in sets.
- Do not use a new battery with a used battery.
- Avoid contact with water or liquid matter.
- Do not expose the remote control to moisture or heat.
- Do not drop the remote control.
- If the battery has leaked in the remote control, carefully wipe the case clean and install new batteries.
- Risk of explosion if two batteries are replaced by an incorrect type.
- Dispose of used batteries according to the instructions on the battery or local regulations or guides.

Remote Control Operating range

Point the remote control toward the projector remote receiver (front and back) when pressing any button.

The maximum operating range for the remote control is about 5 meters and 60 degrees.

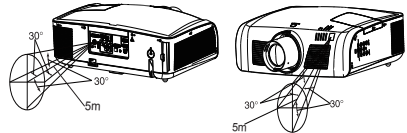

Remote Control Code

The ten different remote control codes (Code 0 - Code 9) are assigned to this projector.

Switching the remote control codes prevents interference from other remote controls when several projectors or video equipment next to each other are operated at the same time. Change the remote control code for the projector first before changing that for the remote control. See "Remote control" in the Setting Menu on page 57.

Press and hold the OK and any number button (0-9) for more than five seconds to switch among Code 0 - Code 9.

The initial code is set to Code 0.

Remote control

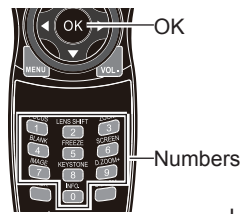

Press and hold the OK and any number button (0-9) for more than five seconds to switch among Code 0 - Code 9.

LED indicator



LED indicator on the remote control will flash twice after the code is successfully set.

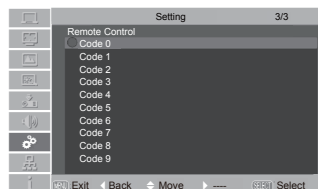

Installation

Positioning the projector

✓ *Note:*

- The brightness in a room has a great influence on image quality. It is recommended to limit the ambient lighting in order to get the best image.
- All measurements are approximate and may vary from the actual sizes.

LC-XN200:

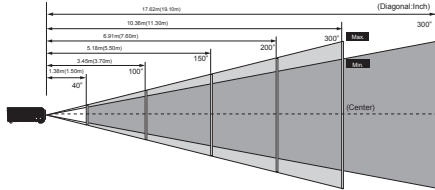

✓ *Note:*

The data in ("") is the project distance for 16:9 aspect ratio.

4:3 :

Screen size (WxH)mm	40"	100"	150"	200"	300"
4:3 aspect ratio	813x610	2032x1524	3048x2286	4064x3048	6096x4572
Maximum	1.38m	3.45m	5.18m	6.91m	10.36m
Minimum	2.35m	5.87m	8.81m	11.74m	17.62m

16:9 :

Screen size (WxH)mm	40"	100"	150"	200"	300"
16:9 aspect ratio	885x498	2213x1245	3320x1867	4427x2490	6641x3735
Maximum	1.50m	3.70m	5.50m	7.60m	11.30m
Minimum	2.50m	6.30m	9.50m	12.70m	19.10m

LC-WXN200:

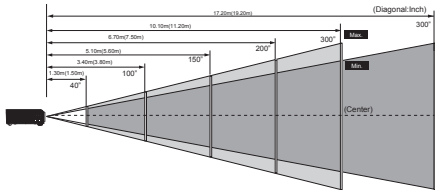

✓ *Note:*

The data in ("") is the project distance for 16:9 aspect ratio.

16:10 :

Screen size (WxH)mm	40"	100"	150"	200"	300"
16:10 aspect ratio	861x538	2154x1346	3231x2019	4307x2692	6461x4038
Maximum	1.30m	3.40m	5.10m	6.70m	10.10m
Minimum	2.20m	5.70m	8.50m	11.40m	17.20m

16:9 :

Screen size (WxH)mm	40"	100"	150"	200"	300"
16:9 aspect ratio	885x498	2213x1245	3320x1867	4427x2490	6641x3735
Maximum	1.50m	3.80m	5.60m	7.50m	11.20m
Minimum	2.60m	6.40m	9.60m	12.80m	19.20m

Adjustable feet

The projection angle can be adjusted up to 5.0 degrees with the adjustable feet.

Rotate the adjustable feet to lift the projector to a certain height. During lifting, rotate the two feet clockwise.

To lower or retract the adjustable feet, rotate the two feet counterclockwise.

Keystone distortion of projected images can be corrected by auto settings, remote control operation or menu operation.

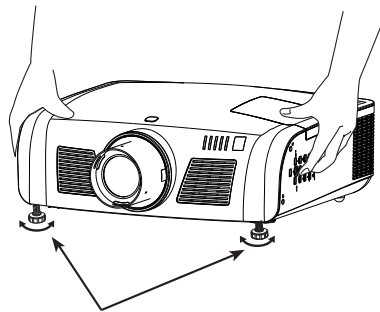

Adjustable feet

Lens installation

Follow the instructions below to install the lens upon replacing or using the optional lens. For the specification of optional lens, contact your dealer.

Removing the lens

- 1 Shift the lens to the center with the lens shift function.(Page 28)
- 2 Turn off the projector, and unplug the AC power cord.
- 3 Press and hold the lens release button on the top cabinet,rotate the lens counterclockwise until the lens cannot be rotated. Draw it out slowly from the projector.



Caution

Do not drop the lens when handling.

Installing the lens

- 1 Remove the lens protective cover.
- 2 Align the red point on the lens with that on the projector to install the lens.
- 3 Rotate the lens clockwise slowly until it clicks.Make sure that the lens is installed completely in the projector.



Caution

While installing the lens, do not hold the release button.

Notes on lens installation:

- Do not touch or remove any part except lens and its relative part. This may cause a malfunction, electric shock, fire or other hazards.
- Make sure the mode of the lens is compatible with your projector before installing or replacing the lens.
- For information about the lens and its installation, contact the local dealer.

Installing the rubber cap

When using the projector in dusty weather or environment, please install the rubber cap to protect the projector lens or optical components from dust accumulation, otherwise, the quality of the projected image will be affected. The rubber cap is made of the elastic material. While installing, put the large opening end into the projector lens on the decoration ring first, then open the small opening end to avoid blocked the projection image.

Lens release button

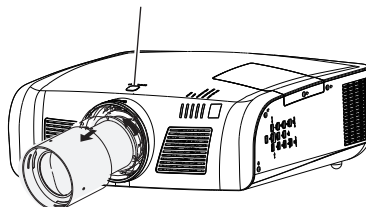

Red point

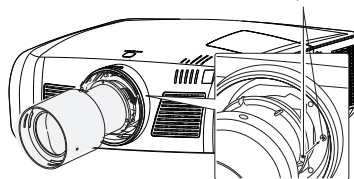

Decorative ring

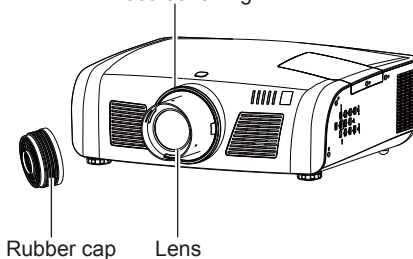

Rubber cap

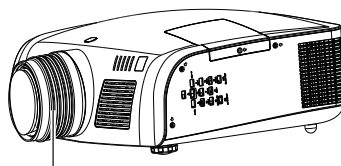

Installation

Lens shift adjustment

Projection lens can be moved from side to side and up to down.
This function makes the positioning of images easy on the screen.

The display position can be shifted upward up to 50% elevation of the display.

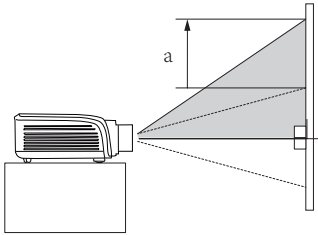

When the lens is shifted to top.

The display position can be shifted downward up to 50% elevation of the display.

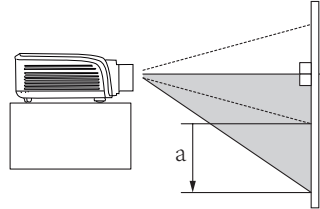

When the lens is shifted to bottom.

The display position can be shifted to the left up to 10% width of the display.

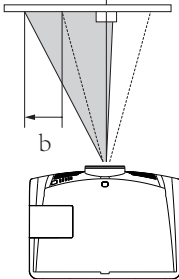

When the lens is shifted to leftmost.

The display position can be shifted to the right up to 10% width of the display.

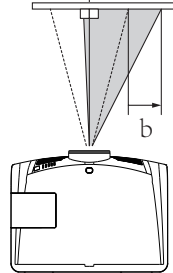

When the lens is shifted to rightmost.

50% elevation of the display and 10% width of the display.

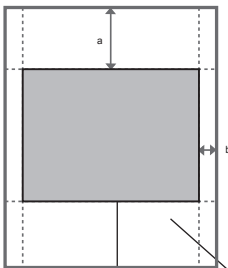

When the lens is shifted to the center.

Shifting range

Connecting to computer(Digital and analog RGB)

Cables used for connection:

- VGA cable
- DVI cable*
- HDMI cable*
- Serial crossover cable*
- BNC cable*

(*=Cables not supplied with the projector)

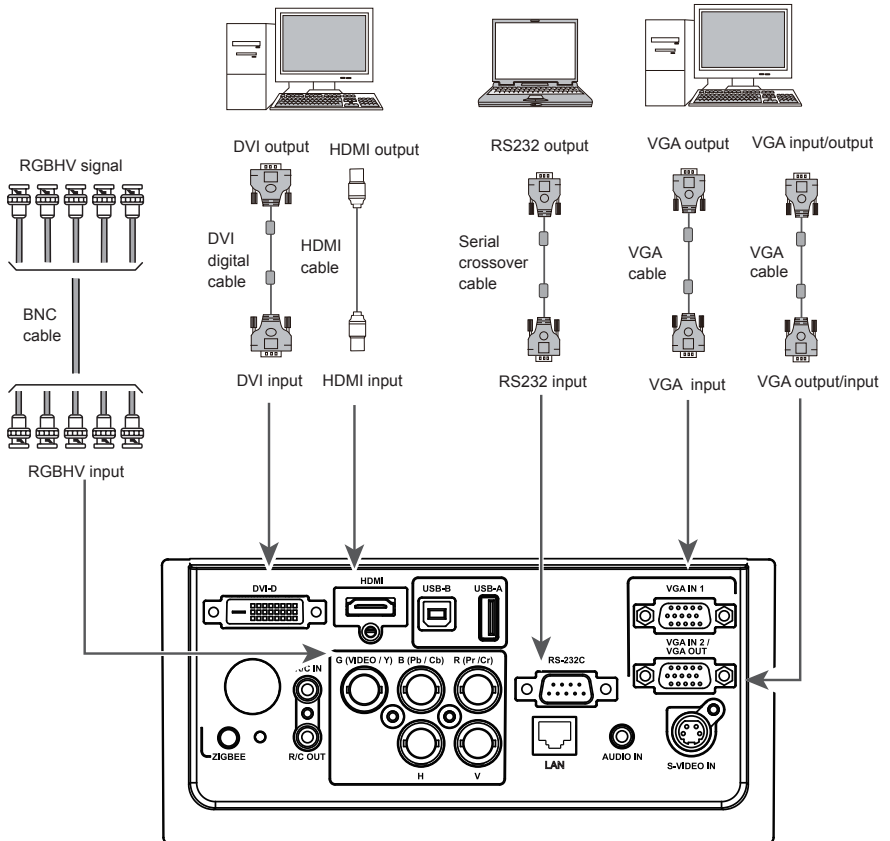

Unplug the power cords of both the projector and external equipment from the AC outlet before connecting the cables.

Installation

Connecting to video equipment (Video, S-Video)

Cables used for connection

- Video cable *
 - RCA cable *
 - BNC cable *
- (*=Cables not supplied with the projector)

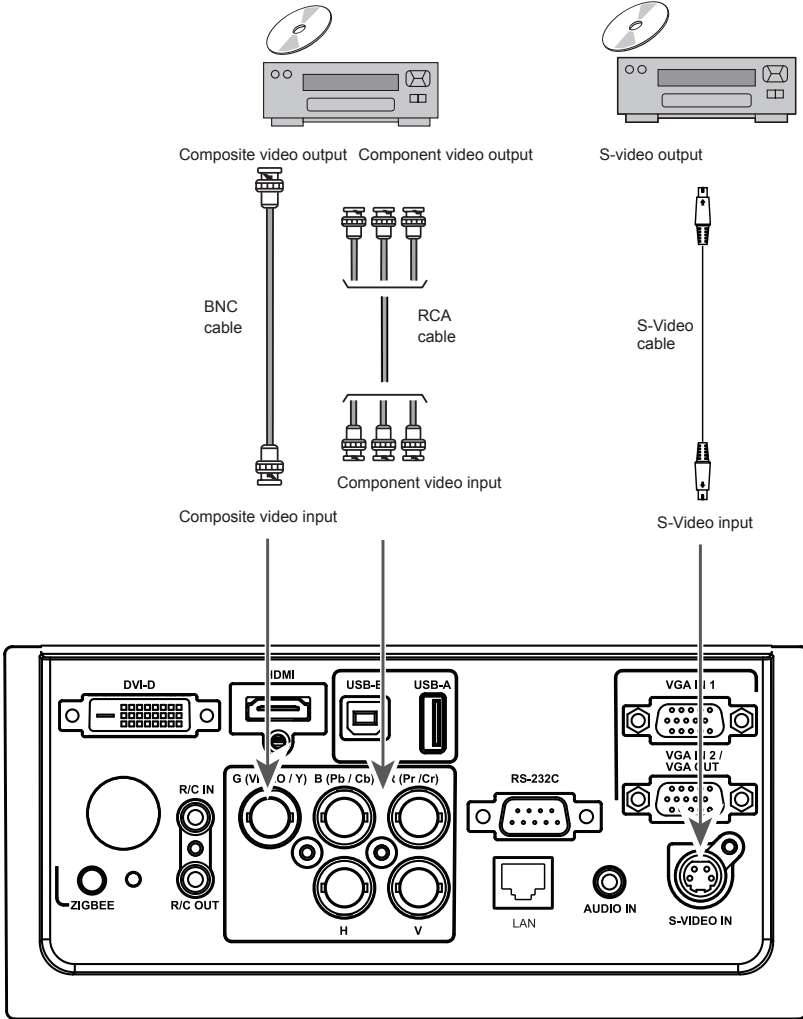

Unplug the power cords of both the projector and external equipment from the AC outlet before connecting the cables.

Connecting to USB device (USB-A, USB-B)

Connect the wireless network adapter to USB –A port

Cables used for connection

- USB-A cable *
- USB-B cable *

(*=Cables not supplied with the projector)

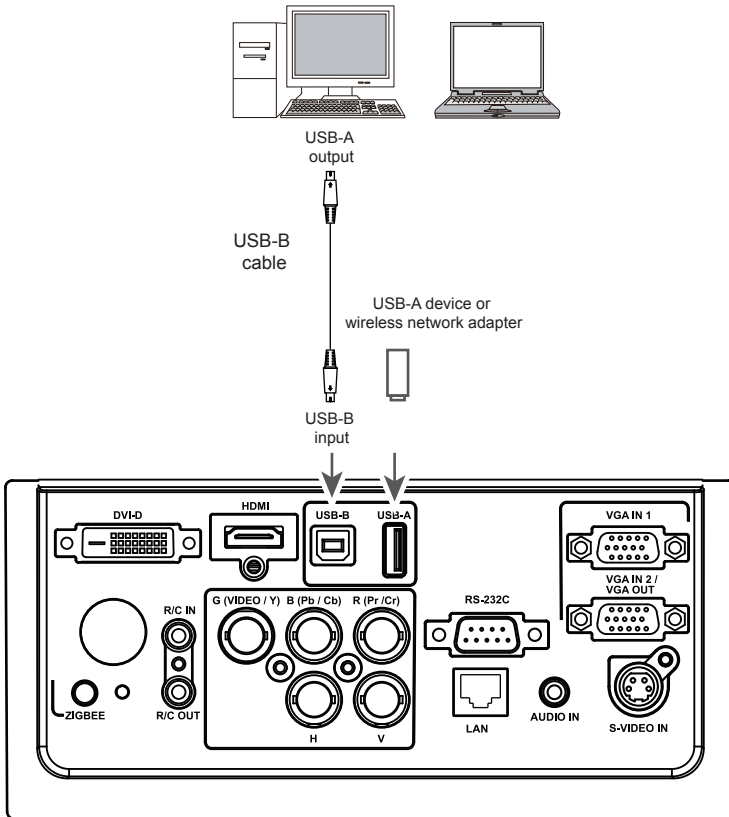

Unplug the power cords of both the projector and external equipment from the AC outlet before connecting the cables.

Installation

Connecting to audio equipment

Cables used for connection:

- Audio cable*

(*=Cables are not supplied with the projector)

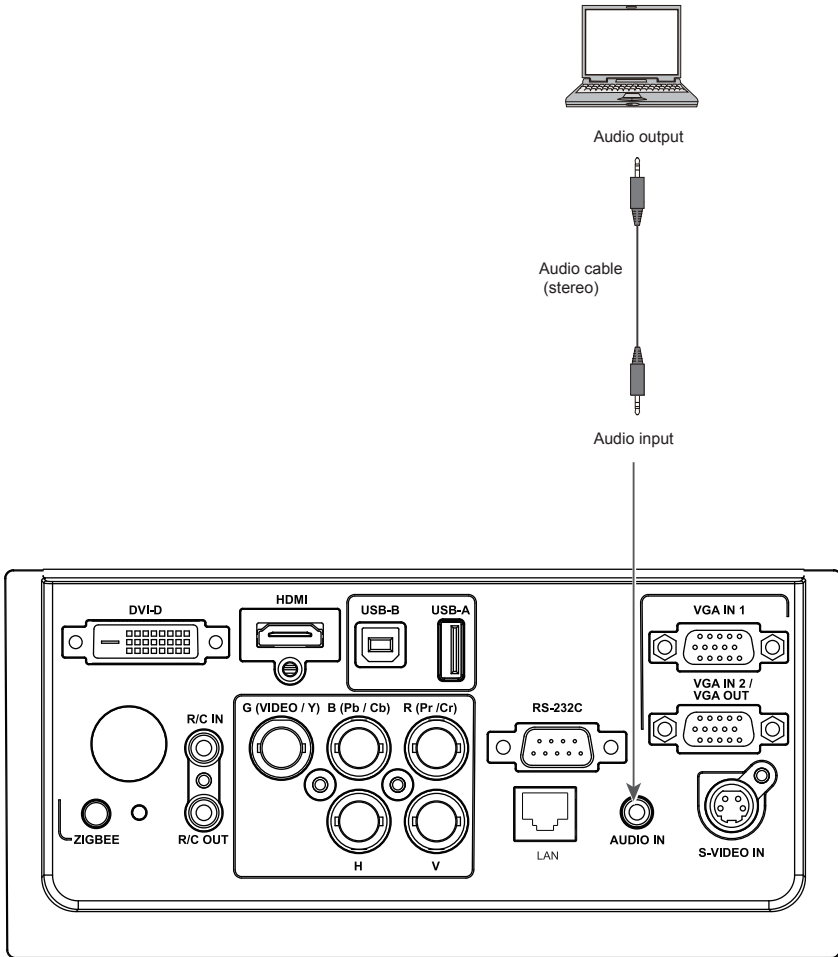

Unplug the power cords of both the projector and external equipment from the AC outlet before connecting the cables.

Connecting the AC power cord

This projector uses nominal input voltages of 100–240V AC and it automatically applies to different input voltages. It is designed to work with a single-phase power system having a grounded neutral conductor.

To reduce the risk of electrical shock, do not plug into any other type of power system. If you are not sure of the type of power being supplied, consult your authorized dealer or service station. Connect the projector with all peripheral equipment before turning it on.

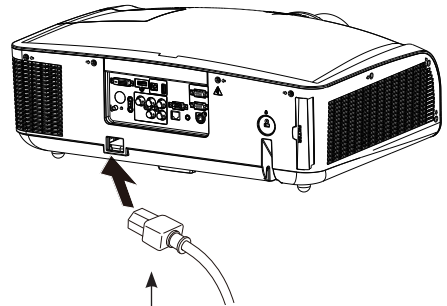

Connect the AC power cord (supplied) to the projector.



Note:

The AC outlet should be near this equipment and must be easily accessible.

✓ Note:

For safety, unplug the AC power cord when the projector is not in use. When the projector is connected to an outlet with AC power cord, it is in stand-by mode and consumes a little electric power.

Note on the power cord

AC power cord must meet the requirements of the country where you use the projector. Confirm the AC plug type with the chart below and proper AC power cord must be used. If the supplied AC power cord does not match, contact your sales dealer.

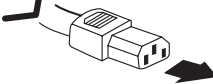
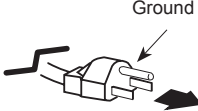
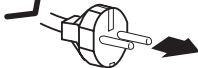
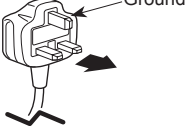
Projector side	AC outlet side		
	For the U.S.A. and Canada	For Continental Europe	For the U.K.
 <p>To power cord connector on your projector.</p>	 <p>To the AC outlet.</p>	 <p>To the AC outlet.</p>	 <p>To the AC outlet.</p>

✓ Note:

Using incorrect power cord may influence the product performance, or even cause hazards like an electric shock or fire. To ensure the product performance and security, please apply the cable of the same model with the original one.

Basic operation

Turn on the projector

1. Complete peripheral connections (with a computer, VCR, etc.) before turning on the projector.
2. Connect the projector's AC power cord into AC outlet. The POWER indicator turns red.
3. Press the POWER button on side control or on the remote control. The POWER indicator becomes green and the cooling fans start to work. The preparation display appears on the screen and the countdown starts.
4. If the projector is locked with a PIN code, a PIN code input dialog box appears. Enter the PIN code as instructed below.

✓ Note:

- When the logo select is set to be "Off" the logo will not be displayed on the screen. (Page 51)
- When the Display function is set to be "Off", the logo and countdown will not be displayed on the screen. (Page 50)
- During the countdown period, all operations are invalid except shutdown.

Enter a PIN code

Select a number by pressing ▲▼ button, and then press ► button to fix the number and move the cursor. The number changes to "*". If you fixed an incorrect number, move the cursor to the number you want to correct by pressing ◀ button, and then select the correct number by pressing ▲▼ button.

Repeat this step to complete entering a three-digit number.

After entering the three-digit number, move the cursor to "Set", then you can start to operate the projector.

If you entered an incorrect PIN code, the "PIN code" and the number (***) turn red. Enter the correct PIN code all over again.

What is PIN code?

PIN (Personal Identification Number) code is a security code that allows the person who knows it to operate the projector. Setting the PIN code can prevent unauthorized use of the projector. A PIN code consists of a three-digit number. Refer to the PIN code lock function in the Advanced setting menu on pages 55 for PIN code lock operation of the projector.



Start-up display

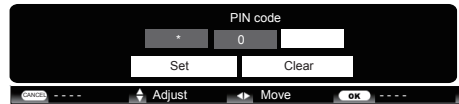

Move the cursor to Set, and press SELECT.



Caution on handling the PIN code
If you forget your PIN code, the projector can no longer be started. Take a special care in setting a new PIN code. Write down the number in a column on page 74 of this manual and keep it properly. Should the PIN code be missing or forgotten, consult your dealer or service center.

Turn off the projector

1. Press the POWER button on side control or on the remote control, and "Power off?" appears on the screen.
2. Then, press the POWER button again in 4 seconds. The POWER indicator starts to flash red, and the cooling fans keep running (You can select the level of fans' quietness and running speed.). Now you can unplug the AC power cord after the fans stop running, otherwise, the service life of the projector will be affected or the projector will can not be turned on or turn on abnormal.
- 3 When the projector has cooled down enough to be turned on again, the POWER indicator stops flashing.

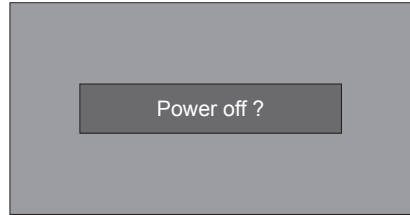

"Power off ? " disappears after 4 seconds.



To maintain the lamp life, once you turn the projector on, wait at least 5 minutes before turning it off.



Do not operate the projector continuously without reset. Continuous use may result in shortening the lamp life. Turn off the projector and let it standby for about an hour in every 24 hours.

✓ **Note:**

- When the On start function is "On", this projector is turned on automatically by connecting the AC power cord to an AC outlet .
- The running speed of cooling fans is changed according to the temperature inside the projector.
- Do not put the projector in a case before it is cooled enough.
- If the WARNING TEMP indicator flashes, see "Warning Temp". (page 58)
- While the POWER indicator is flashing, the lamp is being cooled down and the projector cannot be turned on. Wait until the POWER indicator turns red to turn on the projector again.
- The fan rotation will terminate directly if the AC power cord is unplugged immediately after the projector is turned off.
- The projector can be turned on after the POWER indicator turns red. The waiting time to restart will be shortened when the normal power-off processing for fan cooling is completed, comparing with the time the AC power cord is immediately unplugged after the power-off.

Basic operation

How to operate the on-screen menu

The projector can be adjusted or set via the on-screen menu, each main menu can be divided into several levels of submenus, and submenus are also divided into several levels of secondary submenus.

For each adjustment and setting procedure, refer to the respective sections in this manual.

Side control

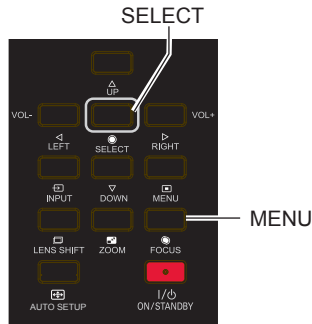

Remote control

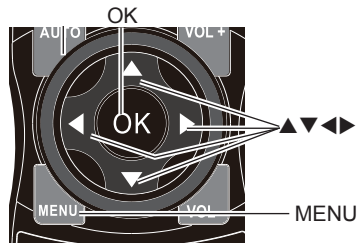

Menu

- 1 Press the MENU button on the side control or the remote control to show the screen menu.
- 2 Press ▲▼ buttons to select an entry in the main menu and then press OK or ► button to enter the submenu.
- 3 Press ▲▼ buttons to select your required item, and then press OK or ► button to set or enter the submenu.
- 4 Press ▲▼◀▶ button to adjust settings or switch among the items. Press the OK button for corresponding operation and then return to the submenu.
- 5 Press ◀ button to return to the previous menu. Press MENU on the remote control again to exit the on screen menu.

Screen menu

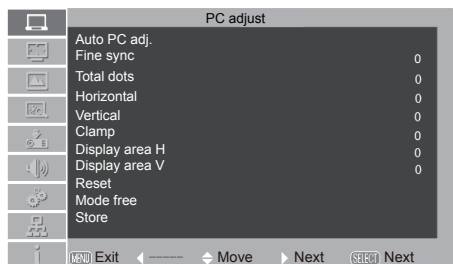

Menu bar

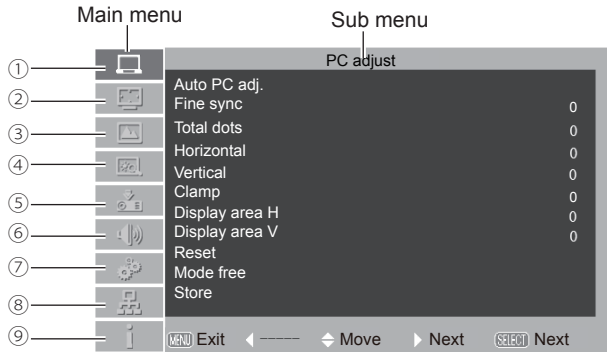

- ① **PC adjust menu**
Adjust computer parameters to match with VGA input signal format: **Auto PC adj.**, **Fine sync**, **Total dots**, **Horizontal**, **Vertical**, **Clamp**, **Display area H**, **Display area V**, **Reset**, **Mode free**, **Store**.
- ② **Screen menu**
If a computer is selected as a signal source, the following setup options for the image size are available: **Normal**, **Wide**, **True**, **Full**, **Custom** or **Digital zoom +/-** .
If video equipment is selected as a signal source, the following setup options for the image size are available: **Normal**, **Wide** or **Custom** (for XGA models) / **Normal**, **Full**, **Wide** or **Custom**(for WXGA models).
- ③ **Image select menu**
The available image modes are: **Dynamic**, **Normal**, **Cinema**, **Blackboard (green)**, **Colorboard** or **User Image**.
- ④ **Image adjust menu**
If a computer is selected as a signal source, the following image adjusting options are available: **Contrast**, **Brightness**, **Color temp.**, **White balance (R/G/B)**, **Sharpness** and **Gamma**.
If video equipment is selected as a signal source, the following image adjusting options are available: **Contrast**, **Brightness**, **Color**, **Tint**, **White balance (R/G/B)**, **Sharpness**, **Gamma**, **Noise reduction** and **Progressive**.
- ⑤ **Input menu**
Select an input source from **HDMI**, **DVI**, **VGA IN 1**, **VGA IN 2**, **Component**, **S-video**, **Video**, **RGBHV**, **Network**, **Image Viewer**, **USB Autorun**.
- ⑥ **Sound menu**
Adjust the volume level or mute the sound.
- ⑦ **Setting menu**
Configure operation settings of the projector.
- ⑧ **Network menu**
Access the network function.
- ⑨ **Information menu**
Display the system information of the projector.

Basic operation

Auto setup

This function is available just by pressing the AUTO SETUP button on the side control or AUTO button on the remote control. The system then automatically performs various settings in the setup menu, including Input search and Auto PC adjust.

Lens shift adjustment

1. Perform the lens shift adjustment with LENS SHIFT button on side control or on the remote control.
2. Lens shift appears on the screen. Press point ▲▼◀▶ button to adjust the screen to desired position without any image distortion. The screen may deviate up-and-down from the central axis of lens shift at most 50% top and bottom or at most 10% left-and-right.
3. Press and hold LENS SHIFT button on side control or remote control for over 5 seconds to move the lens back to central position.

√ Note:

- When the lens is not under shift adjustment, the arrow displays in green.
- When the lens is under shift adjustment, the arrow turns yellow.
- When the lens shift reaches its greatest extent, the arrow turns red.

Zoom adjust

1. Perform zoom adjustment with ZOOM button on side control panel or on the remote control.
2. "Zoom" appears on screen. Press ▲▼button to zoom in or zoom out the image.

Focus adjust

1. Perform focus adjustment with FOCUS button on side control panel or on the remote control.
2. "FOCUS" appears on screen. Press ▲▼button to adjust the focus of the image.

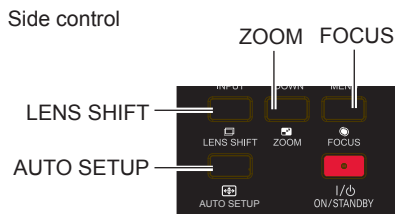

Remote control

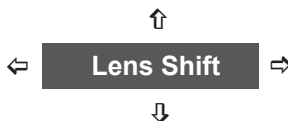
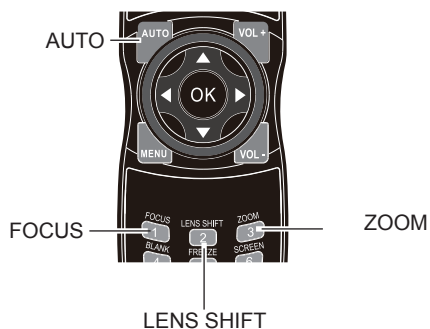

Keystone correction

If a projected image has keystone distortion, follow the steps below to manually correct the keystone distortion.

Press **KEYSTONE** button on the remote control. The keystone dialog box appears. Correct keystone distortion with **▲▼◀▶** buttons. Keystone adjustment can be stored.

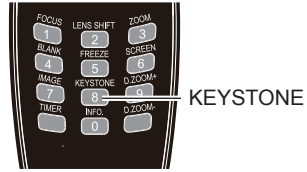

Horizontal / vertical keystone correction:

Reduce the upper width with **▲** button.

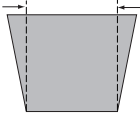

Reduce the lower width with **▼** button.

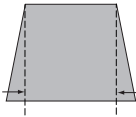

Reduce the left width with **◀** button.

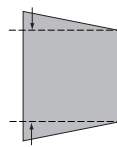

Reduce the right width with **▶** button.

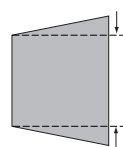

Corners:

Press **▼▶** button to correct upper left keystone distortion.

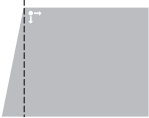

Press **◀▼** button to correct upper right keystone distortion.



Press **◀▲** button to correct lower right keystone distortion.



Press **▲▶** button to correct lower left keystone distortion.

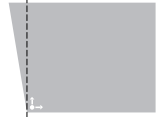

Keystone



- The arrows are white when there is no correction.
- The arrows that are used for correction turns red.
- The arrows disappear at the maximum correction.
- If you press the **KEYSTONE** button on the remote control once more while the keystone dialog box is being displayed, the keystone adjustment is canceled.
- The adjustable range can be limited depending on the input signal.

Basic operation

Sound adjust

Direct operation

Volume

Press the VOL +/- button on the side control panel or on the remote control to adjust the volume.

Side Control Panel

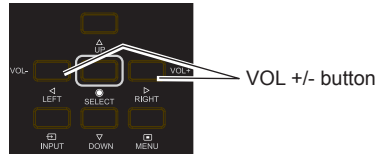

Remote control

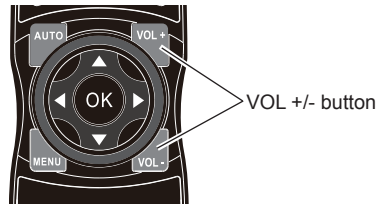

Menu operation

- 1 Press MENU button on the remote control to display the on screen menu.
Press ▼ button to the Sound menu icon.
Press OK or SELECT button to enter the submenu entry.
- 2 Press ▲▼ button to select Volume and then press OK or SELECT button.
- 3 Press ▲▼ button to select Volume or Mute to adjust.

Volume

Press ▲ to turn up the volume and ▼ to turn down the volume.

Mute

Press OK or SELECT button to switch the mute function on/off.

Sound menu



Remote control operation

Using the remote control for some frequently used operations is advisable. Just pressing one of the buttons enables you to make the desired operation quickly without calling up the on-screen menu.

FOCUS

Press FOCUS button on the remote control to adjust the focus of the image.

FREEZE

Press FREEZE button to freeze the image on the screen. To cancel the freeze function, press the FREEZE button again.

IMAGE

Press IMAGE button on the remote control to select the image mode you desire.

LENS SHIFT

Press LENS SHIFT button on the remote control to adjust the projector lens location.

D.ZOOM +/-

Press D.ZOOM +/- button on the remote control to enter digital zoom mode.

Remote control

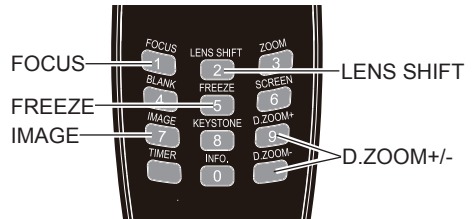

✓ *Note:*

See the next page for the description of other buttons.

Basic operation

BLANK

Press BLANK button to black out the image.
To restore to normal, press the BLANK button again.

The screen changes each time you press the button as follows:

Black out → Normal → Black out → Normal ...



“Blank” disappears after 4 seconds if there is no other button operation.

TIMER

Press TIMER button. The timer display “00:00” appears on the screen and the timer starts to count time (00:00–59:59).

To stop the Timer, press TIMER button. Press TIMER button again, and then the Timer display disappears.



Timer display

INFO.

Press INFO. button on the remote control to display current status information of the projector.

Remote control

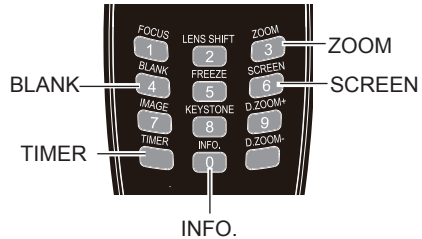

ZOOM

Press ZOOM button on the remote control to zoom in or zoom out the image.

SCREEN

Press SCREEN button on the remote control to select the screen size you desire.

Input select(Analog:VGA IN 1/VGA IN 2/RGBHV)

Direct operation

- Press INPUT button on the side panel to select VGA IN 1, VGA IN 2 or RGBHV.
- Press VGA or RGBHV button directly on the remote control.
- Press VGA button directly on the remote control to switch VGA IN 1 or VGA IN 2.

Side control



Remote control

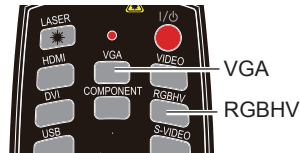

Menu operation

- 1 Press MENU button on the remote control to display the screen menu. Press ▲▼ button to select Input icon, then press OK button.
- 2 Press ▲▼ button to select VGA IN 1, VGA IN 2 or RGBHV, then press OK button.

Input menu

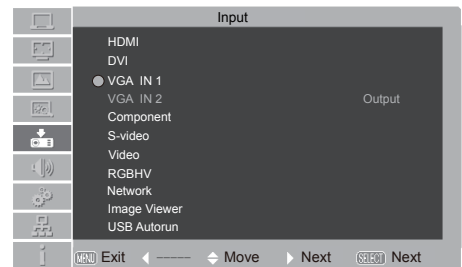

VGA IN 1 When input source is from computer connected to COMPUTER IN 1 terminal with VGA cable, please select VGA IN 1.

VGA IN 2 When input source is from computer connected to COMPUTER IN 2/MONITOR OUT terminal with VGA cable, please select VGA IN 2.

RGBHV When input source is from computer equipment connected to BNC terminal with BNC*5 cable, please select RGBHV.

✓ Note:

- VGA IN 2 can not be selected when using the VGA IN 2/ VGA OUT terminal as MONITOR OUT output.(Page 52)
- When the Input Search function is set to On in the Auto setup function, the input signal will be searched automatically.(Page 49)

Computer input

Input select(Digital:HDMI/DVI/Network/Image Viewer/USB Autorun)

Direct operation

- Press INPUT button on control panel or remote control to select HDMI, DVI, Network, Image Viewer or USB Autorun .
- Press HDMI or DVI button on the remote control to select HDMI or DVI.

Menu operation

- 1 Press MENU button on the remote control to display the screen menu. Press ▲▼ button to select Input icon, then press OK button.
- 2 Press ▲▼ button to select HDMI, DVI, Network, Image Viewer, USB Autorun , then press OK button.

HDMI When input source is from equipment connected to HDMI terminal with HDMI cable, please select HDMI .

DVI When input source is from equipment connected to DVI terminal with DVI cable, please select DVI.

Network When input source is from network connected to LAN terminal with LAN cable or WIFI signal, please select Network. (*WIFI does not support hot plug.*)

USB Autorun When input source is from USB flash device connected to USB-B terminal, please select USB Autorun to project the images stored in USB flash device. Connect the USB flash device between computer and projector with USB cable.

Click "My Computer" on the desktop and select Mirage Presenter (CD driver) .

Side control

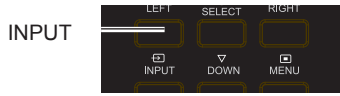

Remote control

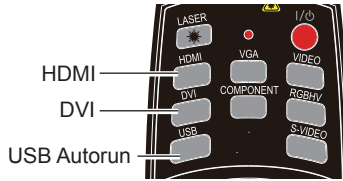

Input menu

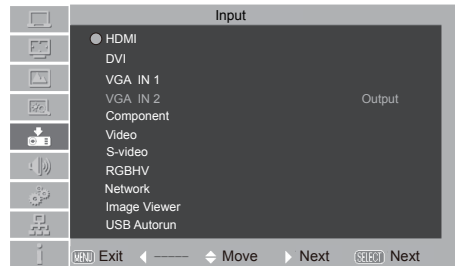

Double click "Mirage Presenter ", then you can project the computer image to the screen. Connect the audio cable, then you can hear sound.

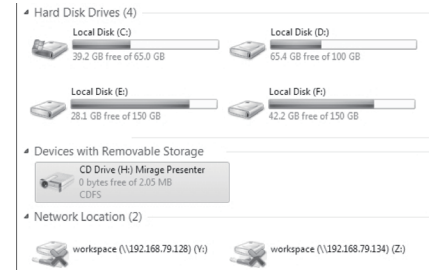
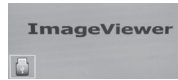

Image Viewer

When input source is from USB flash device connected to USB-A terminal, please select Image Viewer to project the images stored in USB flash device.

When inserting USB flash device into USB-A terminal, the device icon will appear on the screen.



Press OK button on remote control to enter the device and select the image you want to project.

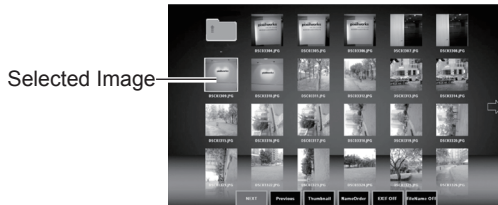

Selected Image

Select Exit icon and press OK button to exit Image viewer function.

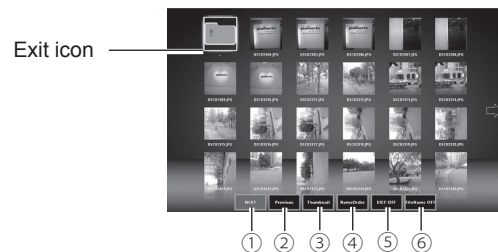

Exit icon

① **NEXT**

Move the option to right.

② **Previous**

Move the option to left.

③ **Thumbnail**

Enter the thumbnail display mode.

④ **NameOrder**

Sort by file or folder name

⑤ **EXIT ON/OFF**

ON/OFF Image rotation.

⑥ **FileName ON/OFF**

ON/OFF Filename is displayed in thumbnail mode.

✓ **Note:**

-When the Input Search function is set to On in the Auto setup function, the input signal will be searched automatically. (Page 49)

-Image Viewer only supports the flash device with FAT32 and FAT file system and the following image file formats: JPEG (JPG), Bitmap (BMP), Portable Network Graphic (PNG), Graphics Interchange Format (GIF) and Tagged Image File Format (TIFF).

Computer input

Computer system select

The projector automatically tunes to various types of computers with its function of Multi-scan system and Auto PC Adjustment. If a computer is selected as a signal source, the projector automatically detects the signal format and tunes to project proper images without any additional setting.

One of the following messages may appear when:

Auto

When the projector cannot recognize the connected signal conforming to the provided PC systems, Auto is displayed on the System Menu box and the Auto PC Adjustment function works to display proper images. If the image is not projected properly, a manual adjustment is required.

There is no signal input from computer. Check the connection between your computer and projector.

VGA system menu

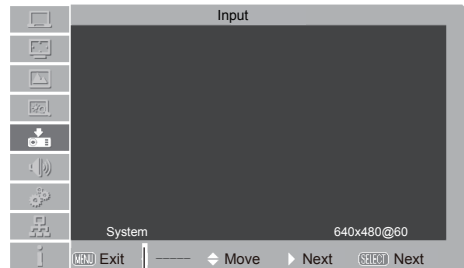

The PC system menu displays the selected system.

Select computer system manually

The system can also be selected manually.

- 1 Press MENU button on the side control panel or remote control to display the on screen menu. Press ▲▼ button to select the input source icon, and press OK button.
- 2 Press ▲▼ button to select System and press the OK button.
- 3 Press ▲▼ button to select your required system, and then press the OK button.

√ Note:

When HDMI , DVI or RGBHV is selected, System menu is disable.

Auto PC adjustment

Auto PC Adjustment function is provided to automatically adjust Fine sync, Total dots, Horizontal and Vertical to conform to your computer.

Menu operation

Auto PC adjustment

- 1 Press MENU button on side control panel or remote control to display the on screen menu. Press ▲▼ button to select the PC adjust icon and press OK button.
- 2 Press ▲▼ button to select Auto PC adj., and then press OK button.

PC adjust menu

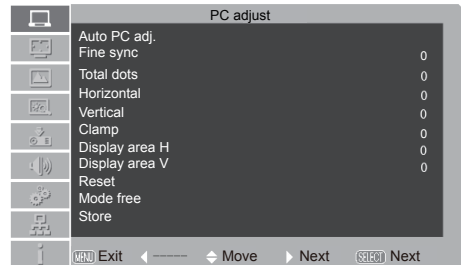

To store the adjusted parameters

The system parameters adjusted in the Auto PC Adjustment can be stored in the projector.(Page 38)

√ Note:

- Total dots and horizontal & vertical positions of some computers cannot be fully adjusted with this Auto PC Adjustment function. When the image is not provided properly with this function, manual adjustments are required.
- The Auto PC Adjustment cannot be operated when 480i, 575i, 480p, 575p, 720p, 1035i or 1080i is selected in the PC System Menu.

Computer input

Manual adjustment via PC

Some computers employ special signal formats which may not be tuned by Multi-scan system of this projector. Manual PC Adjustment is provided for you to precisely adjust several parameters to match those signal formats. The projector has five independent memory areas to store those parameters manually adjusted, which allows you to recall the setting for a specific computer.

- 1 Press MENU button to display the on screen menu. Press ▲▼ to select the PC Adjustment icon and press OK button.
- 2 Press ▲▼ button to select the item to be adjusted and then press OK button to pop up the corresponding dialog box. Press ◀▶ to set the value.

Fine sync

To cut off flicker from the image displayed by pressing ◀▶ to adjust the value.(from 0 to 31).

Total dots

Press ◀▶ to adjust the total dots for a cycle so that it can match the image on computer.

Horizontal

Press ◀▶ to adjust the horizontal image position.

Vertical

Press ◀▶ to adjust the vertical image position.

Clamp

Press ◀▶ to adjust the clamp level. When the image has dark bars, try this function for adjustment.

Display area H

Press ◀▶ to adjust the horizontal area displayed by the projector.

Display area V

Press ◀▶ to adjust the vertical area displayed by the projector.

Reset

To reset the adjusted data, select Reset and press OK. A confirmation box appears and then select Yes. All adjustments will return to their previous figures.

Mode free

To clear the adjusted data, select Mode free and then press OK. Move OK to highlight the Mode you want to clear and then press OK.

Store

To store the adjusted data, select **Store** and then press OK. Move the red arrow indicator to one of the Mode 1 to 5 in which you want to store, and then press OK.

PC adjustment menu

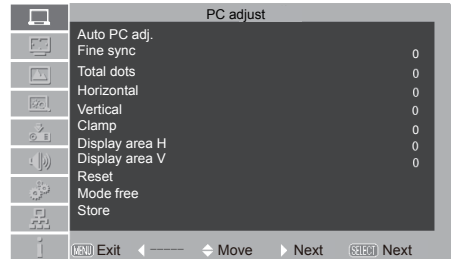

√ Note:

If you select 480i, 575i, 480p, 575p, 720p, 1035i or 1080i from the system menu, the functions of both horizontal image and vertical image will be disabled.

Image Select

Direct operation

Press IMAGE button on the remote control to select your required image quality.

Menu operation

1. Press MENU button to display the screen menu. Press ▲▼ to select the Image select icon and press OK button.
2. Press ▲▼ to select your required image mode and then press OK.

Dynamic

For viewing images in a bright room.

Normal

Normal image quality preset by the system on the projector.

Cinema

For watching movies with multiple gray scale levels.

Blackboard (Green)

For viewing the image projected on a blackboard (green). by enhancing the image quality. This is mainly effective on a green colored board instead of a black colored board.

Colorboard

For images projected onto the red, blue, yellow, or green wallpaper.

User Image

Image quality preset by the user in the Image adjustment menu.

Remote control

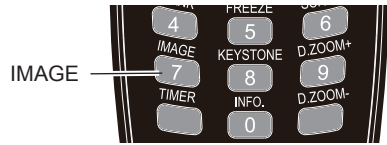
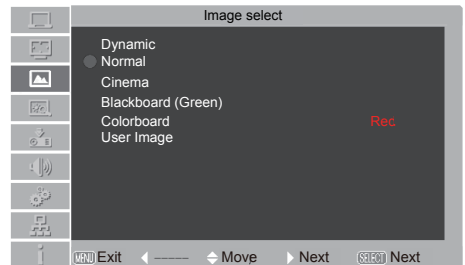

Image select menu



Computer input

Image adjust

1 Press MENU button to display the screen menu, press ▲▼ to select image adjust icon and press OK button.

2 Press ▲▼ to select the setting item, then press OK button, adjust dialogue box appears, press ◀▶ to set the value.

Contrast

Press ◀ to decrease the contrast and ▶ to increase it.

Brightness

Press ◀ to decrease the brightness and ▶ to increase it.

Color temp

Press ◀▶ to select your desired color temperature.(Low, Mid and High)

Red(White balance)

Press ◀ to lighten the red tone and ▶ to deepen it.

Green(White balance)

Press ◀ to lighten the green tone and ▶ to deepen it.

Blue(White balance)

Press ◀ to lighten the blue tone and ▶ to deepen it.

Sharpness

Press ◀ to decrease the sharpness of an image and ▶ to increase it.

Gamma

Press ◀▶ to adjust the gray scale level for better balance of contrast.

Image adjust menu

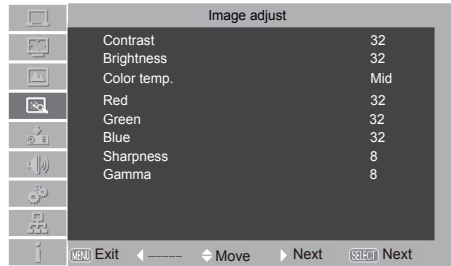

Screen size adjust

The screen size can be reset to the value as you desire.

Direct operation

Press SCREEN button on the remote control to select your required screen quality.

Menu operation

1 Press MENU button to display the screen menu.

2 Press ▲▼ to select your required item and then press OK button.

Normal

To project images in the same aspect ratio with the input signals.

Wide

To provide an image with an aspect ratio of 16:9 by expanding the image width uniformly.

True

Provide images in original size. When the original image size is larger than the screen size, the projector enters display area selection mode automatically. Press ▲▼◀▶ to select a display area. The arrow turns red upon adjustment and disappears upon the maximum limit.

Full

To provide an image to fit the screen.

Custom

Adjust the proportion and position of the screen manually.

When selecting this item, press ► and the corresponding interface appears on the screen. Press ▲▼ button to adjust your required item.

Scale H / Scale V: Adjust the horizontal/vertical screen scale.

H&V: When set to "On", the aspect ratio is fixed. The Scale V appears dimmed and becomes unavailable. Adjust Scale H, and then the screen scale is automatically modified based on the aspect ratio.

Position H / Position V: Adjust the horizontal/vertical screen position.

Common: Save the adjusted scale to all the inputs. Press OK at Common to display a confirmation box. To save the scale, press OK. When Custom is selected, the saved scale is used.

Reset: Reset all the adjusted values. Press OK at Reset to display a confirmation box. To set, press OK at "Yes".

Remote control

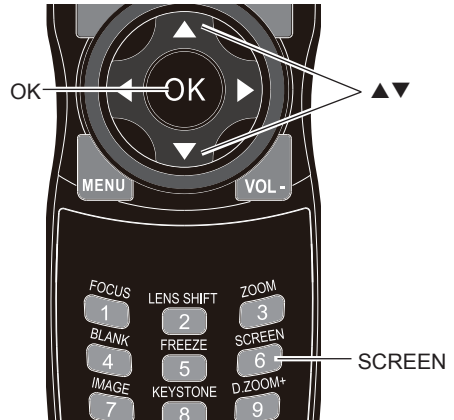

Screen menu

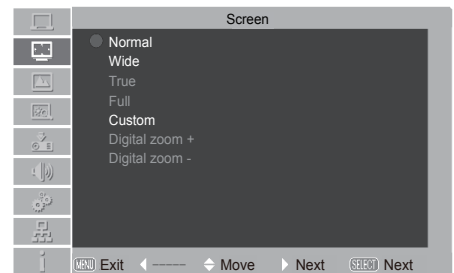

Computer input

Digital zoom +

After you select the digital zoom +, the on-screen menu will disappear, while the information on digital zoom + appears. You can press SELECT button on the side control panel or OK button on the remote control to zoom in the image size, and press ▲▼◀▶ to move the image horizontally and vertically.

The moving is effective only when the image is larger than the size of the screen.

Digital zoom -

After you select the digital zoom -, the on-screen menu will disappear, while the information on digital zoom - appears. You can press SELECT button on the side control panel or OK button on the remote control to zoom out the image size.

To return to original screen size, select the screen size from menu "Screen Size Adjust", or re-select input source from menu "Input Select", or press OK button to adjust the screen size.

✓ Note:

- *The projector does not support images with resolution higher than 1920x1200. If the resolution of your PC screen is so, please re-set to lower resolution before connecting to the projector.*
- *Image data other than XGA (1024 x 768) will be modified to those applicable to the screen size in the initial mode.*
- *If no signal is detected in the PC system menu, options of True, Full and Digital zoom + are not available.*

Input select (Component, S-video, Video)

Direct operation

Press INPUT button on the side control panel or press Component, Video or S-video button on the remote to select Component, Video or S-video.

Side control panel

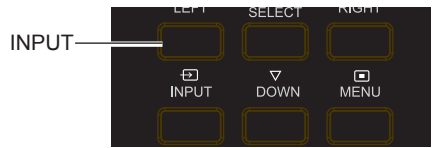

Remote control

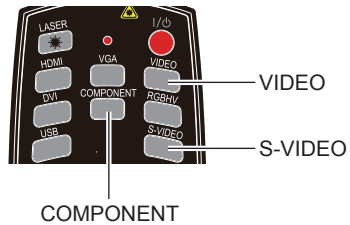

Menu operation

1 Press MENU button on the remote control to display the screen menu. Press ▲▼ button to select Input icon, then press OK button.

2 Press ▲▼ button to select Component, Video or S-video, then press OK button.

Input menu

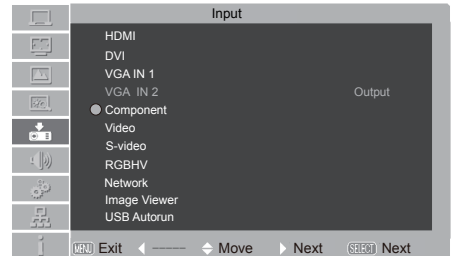

Component Select Component when the input source is from the video equipment connected to Y, Cb/Pb and Cr/Pr terminals with a component cable.

Video Select Video when the video input signal is connected to VIDEO terminal.

S-video Select S-video when the video input signal is connected to S-VIDEO terminal.

Video input

Video system select

- 1 Press MENU button on the remote control to display the screen menu. Press ▲▼ button to select Input icon, then press OK button.
- 2 Press ▲▼ button to select Component, Video or S-video, and then press OK button.
- 3 Press ▲▼ button to select System, and press the OK button. Press ▲▼ button to select your required system, and then press the OK button.

Video or S-video

Auto

The projector automatically detects an incoming video system, and adjusts itself to optimize its performance. When Video System is PAL-M or PAL-N, select the system manually.

PAL/SECAM/NTSC/NTSC4.43/PAL-M/PAL-N

If the projector cannot reproduce proper video images, select a specific broadcast signal format from PAL, SECAM, NTSC, NTSC 4.43, PAL-M and PAL-N.

Component

Auto

The projector automatically detects an input video system, and adjusts itself to optimize its performance.

Component video signal format

If the projector cannot reproduce proper video images, select a specific broadcast signal format from 480i, 575i, 480p, 575p, 720p, 1035i and 1080i.

Video system menu(Video or S-video)

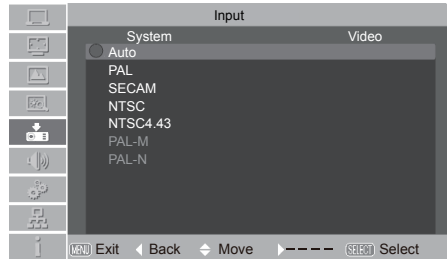

Video system menu(Component)

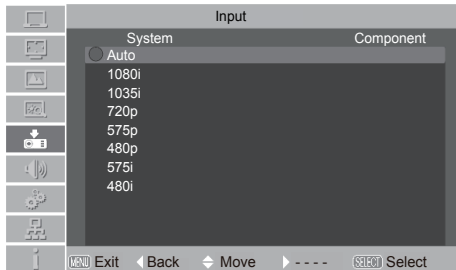

Image Select

Direct operation

Press IMAGE button on the remote control to select your required image quality.

Menu operation

1. Press MENU button to display the screen menu. Press ▲▼ to select the Image Select icon and press OK button.
2. Press ▲▼ to select image mode you desire and then press OK.

Remote control



Dynamic

For viewing images in a bright room.

Normal

Normal image quality preset by the system on the projector.

Cinema

For watching movies with multiple gray scale levels.

Blackboard (Green)

For viewing the image projected on a blackboard (green) by enhancing the image quality. This is mainly effective on a green colored board instead of a black colored board.

Colorboard

For images projected onto the red, blue, yellow, or green wallpaper.

User Image

Image quality preset by the user in the Image adjustment menu.(Page 46)

Image select menu

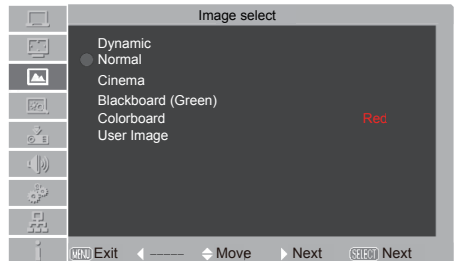

Video input

Image adjust

1 Press MENU button to display the screen menu, press ▲▼ to select image adjust icon and press OK button.

2 Press ◀▶ to select the item and press OK button, adjust dialogue box appears. Press ◀▶ to set the value.

Contrast

Press ◀ to decrease the contrast and ▶ to increase it.

Brightness

Press ◀ to decrease the brightness and ▶ to increase it.

Color

Press ◀ to decrease the Chroma and ▶ to increase it.

Tint

Press ◀▶ to select the appropriate tone for the image.

Red(White balance)

Press ◀ to lighten the red tone and ▶ to deepen it.

Green(White balance)

Press ◀ to lighten the green tone and ▶ to deepen it.

Blue(White balance)

Press ◀ to lighten the blue tone and ▶ to deepen it.

Sharpness

Press ◀ to decrease the sharpness of an image and ▶ to increase it.

Gamma

Press ◀▶ to adjust the gray scale level for better balance of contrast.

Noise reduction

To reduce noise interference on the screen. Select the function to get smoother images.

Progressive

An interlaced video signal can be displayed in a progressive image. Select one of the following options:

Off.....Disabled.

L1.....For a motion image.

L2.....For a still image.

Film...For watching a film. With this function, the projector reproduces images faithful to the original film quality, reducing distortion.

Image adjust menu

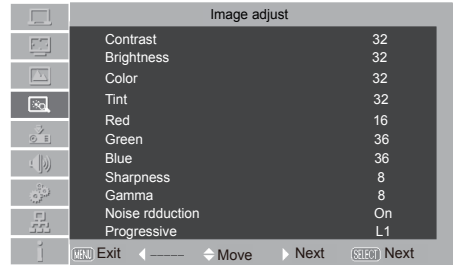

Screen size adjust

The screen size can be reset as you desire.

- 1 Press MENU button to display the screen menu. Press ▲▼ button to select screen icon and then press OK button.
- 2 Press ▲▼ to select the item you desire and then press OK button.

Normal

To project images in the same aspect ratio with the input signals.

Full

To provide an image to fit the screen.

Wide

To provide an image with an aspect ratio of 16:9 by expanding the image width uniformly.

Custom

Adjust the proportion and position of the screen manually.

Press ► button at Custom and the Custom appears on the screen. Press ▲▼ button to adjust your required item.

Scale H/Scale V: Adjust H/V screen scale.

H&V: When set to "On", the aspect ratio is fixed. The Scale V appears dimmed and becomes unavailable. Adjust Scale H, and then the screen scale is automatically modified based on the aspect ratio.

Position H/Position V: Adjust the H/V image position.

Common: Save the adjusted scale to all the inputs. Press OK button at Common to display a confirmation box. To save the scale, press OK button at "YES". When Custom is selected, the saved scale is used.

Reset: Reset all the adjusted values. Press OK button at Reset to display a confirmation box. To set, press OK button at "YES".

✓ Note:

- If no signal is detected, the system will be automatically set as normal state and the adjustment prompt box disappears.
- The Scale H/Scale V and Position H/Position V shall be adjusted according to the input signal.

Remote control

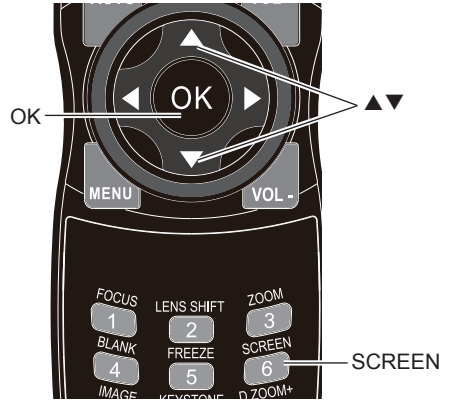

Screen menu

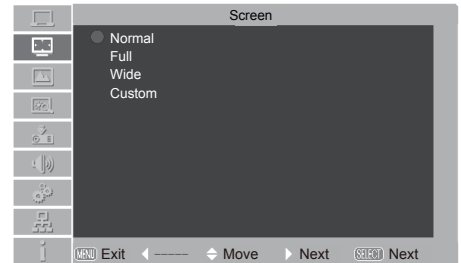

Setting

Setting

The projector has Setup menu that allows you to set the other various function described as follows.

- 1 Press MENU button to display the screen menu. Press ▲▼ button to select Setting icon and then press OK button.
- 2 Press ▲▼ to select the desired item to be adjusted, and then press ► to switch the items.
3. Press ▲▼ button to select desired item and press OK button.



Language

The language used in screen menu is available in Traditional Chinese, Simple Chinese, English, French, Spanish, Portuguese, German, Italian, Japanese, Korean, Russian, Finnish, Dutch, Thai, Vietnam, Turkish, African, Indonesian, Farsi and Arabian.

Setting menu

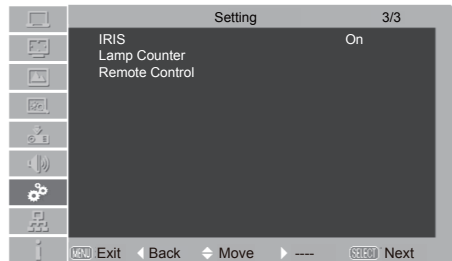
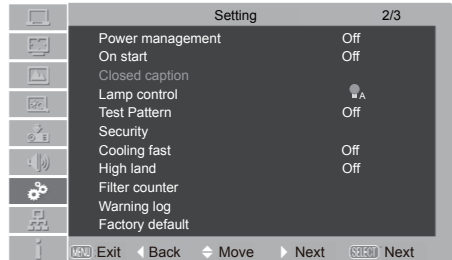
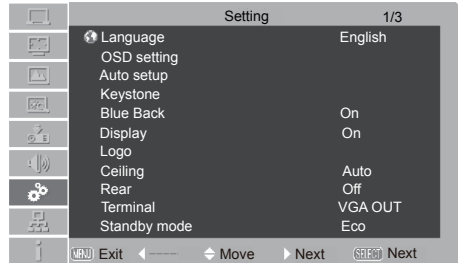

OSD setting

This item is used to set the position, translucent or background color of the screen menu.

Menu position

This function enables you to change the position for displaying the screen menu. Select Menu position, and press Select button. Every time you press OK button, the screen position will change as follows:

upper left → upper right → Center → lower left
 → lower right → upper left → ...

Translucent

This function enables you to change the transparency for displaying screen menu. Press ▲▼ button to select Off, High, Mid or Low.

Background color

This function enables you to change the background color for displaying screen menu. Press ▲▼ to select from 0-6.

Auto setup

Allows you to perform input search, auto PC adj. , press the AUTO SETUP button on the side control or AUTO button on the remote control. The functions can be switched based on the steps below.

Input search

Allows you to automatically detect input signals. It stops when a signal is found. Press ▲▼ to select an option below:

Off.....Disabled.

On.....Enabled. This function is used to detect input signals automatically , and stops when finding a signal.

Auto PC adj

On.....Press the AUTO SETUP button on the side control panel or AUTO button on the remote control to enable Auto PC adj. function automatically.

Off.....Disable Auto PC adj. function.

OSD setting menu

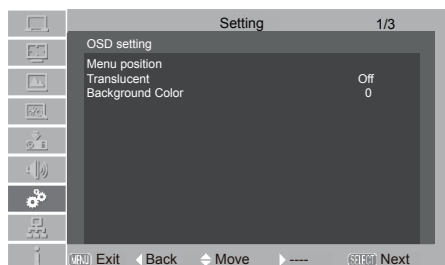

Auto setup menu

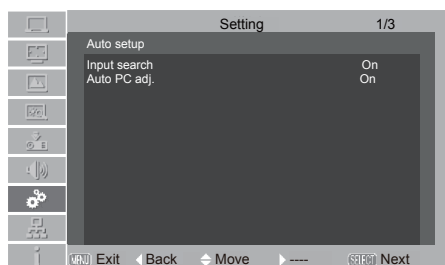

✓Note:

- Only the last selected input source can be detected.
- If the INPUT button on the side control or on the remote control is pressed during Input search is in progress, Input search will stop and go back to the previous input signal.
- Fine sync., Total dots, Horizontal and Vertical position of some computers cannot be fully adjusted with the Auto PC Adjustment function. When the image is not provided properly with this operation, manual adjustments are required.

Setting

Keystone

This function is used to reset the keystone correction after the AC power cord is unplugged. Press ▲▼◀▶ to select the items below:

Keystone

- Store.....Store the keystone correction even when the AC power cord is unplugged.
- ResetReset the keystone correction when the AC power cord is unplugged.

H/V Keystone

Press ▲▼◀▶ to correct keystone distortion in horizontal and vertical position.

Corner

Press ▲▼ button on the remote control to select Corner and press OK button. Corner correction dialogue window appears on the screen.

Press ▲▼◀▶ buttons to correct corner keystone distortion. Correcting order is as follows:

upper left → upper right → lower right → lower left → ...

Press ▼▶ button to correct upper left keystone distortion.

Press ◀▼ button to correct upper right keystone distortion.

Press ◀▲ button to correct lower right keystone distortion.

Press ▲▶ button to correct lower left keystone distortion.

Blue back

Enable to select the screen background of the projector when there is no signal detected. Press ▲▼ button on the remote control to switch on/off.

OnEnable the blue background for projection.

OffDisable the blue background.

Display

Enable to decide whether to display the on-start displays. (Including countdown)

Press ▲▼ button on the remote control to switch on/off.

On Display startup screen.

Off Display the input image instead of the on-start screen.

Keystone menu

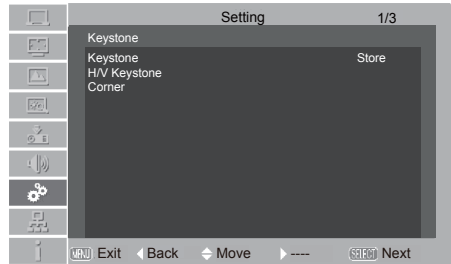

Corners:

Press ▼▶ button to correct upper left keystone distortion.

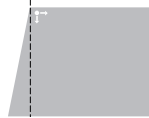

Press ◀▼ button to correct upper right keystone distortion.



Press ◀▲ button to correct lower right keystone distortion.



Press ▲▶ button to correct lower left keystone distortion.

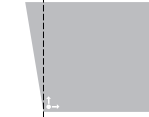

Logo (Logo and Logo PIN code settings)

This function allows you to customize the screen logo with Logo select, Logo PIN code lock and Logo PIN code change functions.

Logo select

This function decides on the starting-up display from among following options.

Press ▲▼ button on the remote control to select from Default and Off:

Default Show the factory-set logo.

Off Show the countdown display only.

Logo PIN code lock

This function prevents an unauthorized person from changing the screen logo.

Off The screen logo can be selected default or off freely from the Logo select Menu.

On The screen logo cannot be changed without a Logo PIN code.

If you want to change the Logo PIN code lock setting, press the OK button and the Logo PIN code dialog box appears. Enter a Logo PIN code by following the steps below.

Password resetting

Press ▲▼ buttons to enter a number. Press the ► button to fix the number and move the red frame pointer to the next box. The number changes to “*”. If you fixed an incorrect number, use the Point ◀ button to move the pointer to the number you want to correct, and then press ▲▼ enter the correct number.

Repeat this step to complete entering a three-digit number.

After entering the three-digit number, move the pointer to Set. Press the SELECT button so that you can start to operate the projector.

Logo PIN code change

Logo PIN code can be changed to your desired three- digit number. Press the SELECT button to select Logo PIN code change. Logo Pin code dialog box appears, use the Point ▲▼ buttons to enter the correct code. The New Logo PIN code input dialog box appears. Set a new Logo PIN code, confirmation box appears, choose yes to set the new Logo Pin code.

Be sure to note the new Logo PIN code and keep it on hand. If you lost the number, you could no longer change the Logo PIN code setting.

If you entered an incorrect Logo PIN code, Logo PIN code and the number (***) will turn red for a moment. Enter the correct Logo PIN code all over again.

Caution:

When you have changed the logo pin code, write down the new pin code in column of the logo pin code no. Memo on page 74, and keep it securely. Should the logo pin code be lost or forgotten, the logo pin code setting can no longer be changed.

LOGO menu

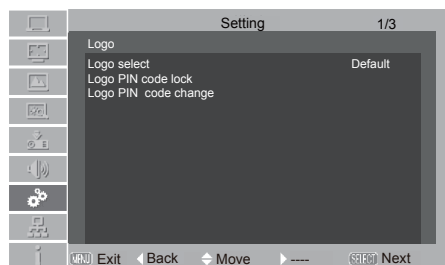

Setting

Ceiling

This function is used to project the image from a ceiling-mounted projector.

Press ▲▼ button on the remote control to select the item you desire.

On.....The image will be top/bottom and left/right reversed.

Auto.... The projector automatically identifies its vertical or inverse state.

OffDisable this function.

Rear

When the function is set to On, the image is left/right reversed. Enable to project the image to a rear projection screen.

Press ▲▼ button on the remote control to select the item you desire.

On.....The image will be left/right reversed.

OffDisable this function.

Terminal

The VGA IN 2/VGA OUT terminal can be used as computer input or monitor output.

Press ▲▼ to select VGA IN 2 or VGA OUT.

VGA IN 2VGA IN 2 input.

VGA OUT.....VGA output.

Terminal menu

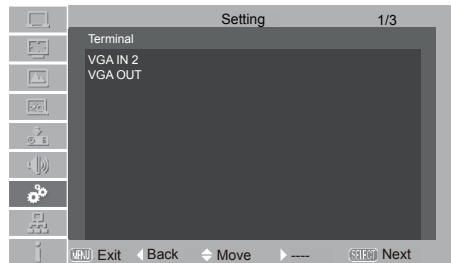

Standby mode

This function is available when operating the projector via network.

Press ▲▼ button on the remote control to select the item you desire.

EcoIn this state, network function, VGA OUT is disable after turning off the projector. No command but POWER ON is enable for RS232 after turning off the projector.

Normal ..Supply the power to the network function even after turning off the projector. You can turn on/ off the projector via network or modify network environment while the projector is turned off.

Power management

For reducing power consumption as well as maintaining the lamp life, the Power management function turns off the projection lamp when the projector is not operated for a certain period.

Select one of the following options:

Ready When the lamp has been fully cooled down, the POWER indicator changes to green blinking. In this condition, the projection lamp will be turned on if the input signal is reconnected or any button on the side control or remote control is pressed. The projector will be power off while press the Power button on the side control or remote control.

Shut down When the lamp has been fully cooled down, the power will be turned off.

Off Power management function is off.

Timer If the input signal is interrupted and no button is pressed for more than 30 seconds, the timer display with No signal appears. It starts the countdown until the lamp is turned off. Press ▲▼ buttons to set the Timer (1-30min.)

Ready countdown. Set the time that ready status transfers to standby status automatically. (0-30min. 0 Min: not transfer automatically) In ready status, press POWER button to switch to standby status, and press any other button to turn on the projector.

On start

Enable the projector to be turned on automatically just by connecting the AC power cord to an outlet when this function is set to On.

Power management menu

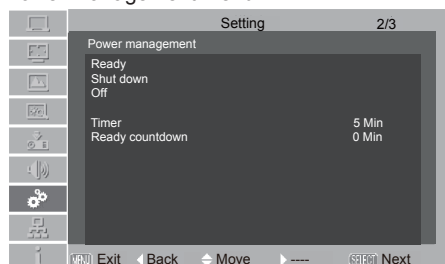

Power management



Time left before Lamp is off.

√ **Note:**

Factory default is Ready: 5 Min.

Ready countdown: 0 Min.

Setting

Closed Caption

Allows the subtitle to be displayed for the audio contents or other information. If the input source contains closed caption, you can enable this function and change the channel.

Closed caption

Press ▲▼ to select OFF, CC1, CC2, CC3 or CC4.

Color

Press ▲▼ to select Color or White.

Closed caption menu

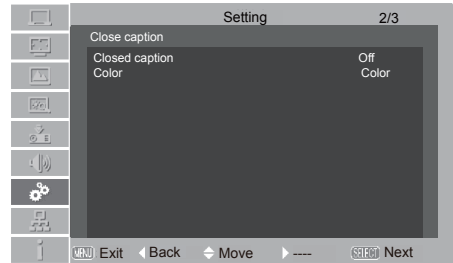

√ Note:

Only under the following circumstances you can select Closed Caption:

- The input is composite video signal or S-Video in the NTSC system.
- The system should be set to NTSC or Auto in the video system.
- The icon of Closed Caption appears dimmed when unavailable.
- Closed Caption cannot be selected when the screen menu and Timer is displayed.

Lamp control

Change the brightness of the screen.

- NormalNormal brightness.
- Auto.....Adjust the lamp brightness according to the input signal.
- EcoLower brightness, reducing power consumption and extending the lamp life.

Test Pattern

This function is used to set the internal test signal.

Press ▲▼ to select Off or 1-12.

Security (Key lock and PIN code lock)

This function allows you to use the Key lock and PIN code lock function to set the security for the projector operation.

Key lock

This function locks the side control and remote control buttons to prevent operation by unauthorized persons. Select Key lock and then press the SELECT button, and select the desired item by pressing ◀▶ button.

- Off Unlocked.
- Projector Lock the operation of the side control. To unlock, use the remote control.
- Remote Control Lock the operation of the remote control. To unlock, use the side control.

If the side control accidentally becomes locked and you do not have the remote control nearby or there is something wrong with your remote control, contact the dealer where you purchased the projector or the service center.

PIN code lock

This function prevents the projector from being operated by unauthorized persons and provides the following setting options for security.

- Off Unlocked.
- On Enter the PIN code every time turning on the projector.

Whenever you change the PIN code lock setting or the PIN code (the three-digit number), you are required to enter the PIN code. The "111" is set as the initial PIN code at the factory.

If you want to change the PIN code lock setting, press SELECT button and the PIN code dialog box appears.

Enter a PIN code

Press ▲▼ buttons to enter a number. Press ▶ button to fix the number and move the red frame pointer to the next box. The number changes to "*". If you fixed an incorrect number, press ◀ button to move the pointer to the number you want to correct, and then press ▲▼ enter the correct number.

Repeat this step to complete entering a three-digit number.

After entering the three-digit number, move the pointer to "Set". Press the SELECT button so that you can start to operate the projector.

If you entered an incorrect PIN code, PIN code and the number (***) will turn red for a moment. Enter the correct PIN code all over again.

Change the PIN code lock setting

Press ◀▶ buttons to select Yes or No, and then press the SELECT button to make a choice.

PIN code change

The PIN code can be changed to your desired three-digit number. Press SELECT button to select PIN code change. Pin code dialog box appears, Press ▲ buttons to enter the correct code. The New PIN code input dialog box appears. Set a new PIN code.

Caution:

When you have changed the pin code, write down the new pin code in column of the pin code no. Memo on page 74, and keep it securely. If you forget your pin code, the projector can no longer be started.

Security menu

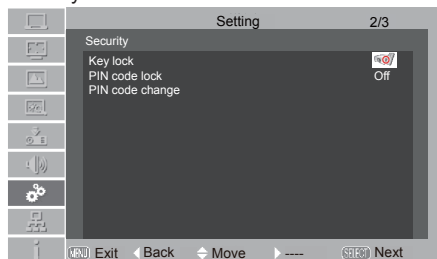

Setting

Cooling fast

This function provides the following options in the cooling fans' operation after turning off the projector.

Off..... Normal operation.

On Faster and louder than Normal, cooling time is shorter.

High land

Enable to control the fan through the Setup menu.

You can select the running speed of the fan according to the altitude of the location where the projector is installed.

Off.....Normal speed. Set it so if the projector is operated at a lower altitude.

On.....Faster than Off. Set it so if the projector is operated at a higher altitude because fans will produce weaker effects.

Filter counter

This function is used to set a frequency for the filter cleaning.

When the projector reached a specified time between cleanings, a Filter warning icon appears on the screen, notifying the cleaning is necessary. After cleaning the filter, be sure to select filter counter reset and set the timer. The Filter warning icon will not turn off until the Filter counter is reset.

Filter counter.....The time that filter used.

Timer.....Frequency for filter cleaning.

Filter counter reset....Reset the filter counter.

Filter counter menu

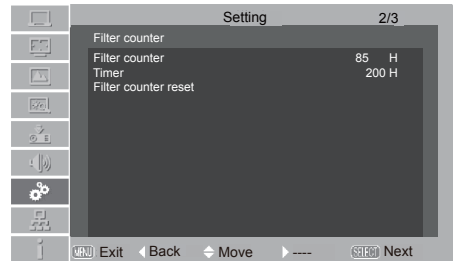

Warning log

Recording abnormal operations, facilitating to diagnosing errors. The log lists the latest 9 warning messages in time sequence.(The latest warning message is arranged at the top of the warning log list.)

✓ *Note:*

When Factory Default is selected, all log records will be deleted.

Factory default

This function returns all setting values except for the User logo, PIN code lock, Logo PIN code lock, Lamp counter and Filter counter to the factory default settings.

IRIS

This function is used to increase the contrast of the image.

On.... Enable Iris function, increase the contrast of the image.

Off....Disable Iris function.

Lamp Counter

This function is used to display the cumulative lamp operating time and reset the lamp counter.

When the total lighting time of a lamp exceeds the recommended total hours of use, the Lamp replacement icon (page 61) will appear on the screen, indicating that the end of lamp life is reached.

When replacing the projection lamp, reset lamp counter. See "Resetting the Lamp Counter" on page 62.

Remote control code

The projector is assigned 10 different remote control codes (Code 0-9).

The remote control code should be the same one from the projector and the remote control. As setting the remote control as Code 7 to operate the projector, the remote control code on the projector also must be switched to Code 7.

Change the projector's code: Select "Remote control" in setting menu. Choose the code.

Change the remote control code: Press the OK and the number key (0-9) on the remote control for more than 5 seconds to switch the code.

✓ Note:

- The default remote control code is Code 0.
- If the remote control code set on the projector and remote control is different, it will not execute any operation. In this case, switch the remote control code to the same one with the projector.
- The remote control code will be reset after the battery is removed for a long period of time.

The information menu is used to detect signal of projected image and running state.

Menu operation

Press MENU button to display the screen menu. Press ▲▼ to select information icon, the information menu will appear and the information is displayed. Shown as the right image.

See below for displayed information.

Input

The selected input source is displayed.

H-sync freq .

The horizontal frequency of the input signal is displayed in KHz or - - - -KHz when no signal.

V-sync freq .

The vertical frequency of the input signal is displayed in Hz or - - - - Hz when no signal. Numbers of Hz doubles when during Interlace.

Screen

The selected screen size is displayed.

Language

The selected language is displayed.

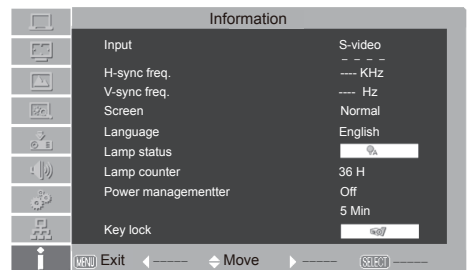

Lamp status

The selected lamp mode is displayed.

Lamp Time

Display the cumulative used time of the lamp.

Power management

Off, Ready or Shut down is displayed.

Key lock

Display Off, Remote Control or the Projector.

Maintenance and cleaning

WARNING TEMP indicator

The WARNING TEMP indicator shows the state of the function which protects the projector. Check the state of the WARNING TEMP indicator and the POWER indicator to take proper maintenance.

The projector is shut down and the WARNING TEMP indicator is blinking red.

When the temperature inside the projector exceeds the normal temperature, the projector is automatically shut down to protect internal components. The POWER indicator is blinking while the projector is being cooled down. When the projector has cooled down enough (to its normal operating temperature), it can be turned on again by pressing the POWER button.

✓ *Note:*

The WARNING TEMP indicator continues to blink even after the temperature inside the projector returns to normal. When the projector is turned on again, the WARNING TEMP indicator stops blinking.

Check the items below:

- Did you provide appropriate space for the projector to be ventilated?
Check the installing condition to see if ventilation slots are not blocked.
- Has the projector been installed near the duct or vent of an air conditioning?
Move the installation of the projector away from the duct or vent.
- Are the air filters clean? Clean the air filters periodically.

The projector is shut down and the WARNING TEMP indicator lights red.

When the projector detects an abnormal condition, it is automatically shut down to protect the internal components and the WARNING TEMP indicator lights red. In this case, unplug the AC power cord and plug it, and then turn on the projector once again to verify operation. If the projector cannot be turned on and the WARNING TEMP indicator lights red, unplug the AC power cord and contact the service station for servicing and maintenance.



Caution

Do not leave the projector with the AC power cord connected under an abnormal condition. It may result in fire or electric shock.

Indicator

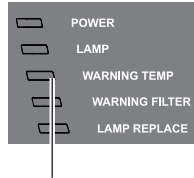

WARNING TEMP indicator blinks red.

Indicator

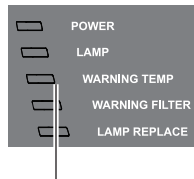

WARNING TEMP indicator lights red.

Cleaning the air filter

The air filter prevents dust from accumulating on the surface of the optical elements inside the projector. Should the air filter become clogged with dust particles, it will reduce cooling fans' effectiveness and may result in a buildup of internal heat and adversely affects the life of the projector. If the Filter warning icon appears on the screen, the air filter should be cleaned immediately. Clean the air filter following the steps below.

- 1 Turn off the projector, and unplug the AC power cord from the AC outlet.
- 2 Remove the air filter.
- 3 Gently clean the filter with a brush.
- 4 Reinstall the filter into the projector properly.



Caution

Do not operate the projector with the air filter removed. Dust may accumulate on the optical elements, degrading image quality. Do not put any small objects into the air intake vents. Otherwise, it may result in malfunction of the projector.

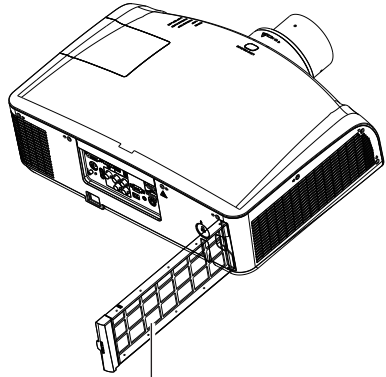

Air filter

Resetting the filter counter

Be sure to reset the filter counter after cleaning or replacing the filter.

1. Press Menu on the remote control to display the on screen menu. Press ▲▼ to select the icon for the setting menu. Then press ► or press OK.
2. Press ▲▼ to select Filter counter, and then press ► or press Select. Press ▲▼ to select Filter counter reset, then press OK. At the time, you will see the prompt information "Filter counter Reset?" displayed on the screen. Select Yes.
3. When another dialog box pops up, you should select Yes and reset the filter.

Recommendation

We recommend avoiding dusty/smoky environments when you operate the projector. Usage in these environments may cause poor image quality.

When you use the projector under dusty or smoky conditions, dust may accumulate on the lens, LCD panels, or optical elements inside the projector. When the symptoms above are noticed, contact your authorized dealer or service station for proper cleaning.

Replacement Filter Type

ORDER REPLACEMENT FILTER

Replacement filter can be ordered through your dealer. When ordering a filter, give the following information to the dealer.

Model No. of your projector: LC-XN200, LC-WXN200, LC-XN200L, LC-WXN200L.

Maintenance and cleaning

Lens cover

When moving the projector or the projector is not under use for a long time, please put on the lens cover.

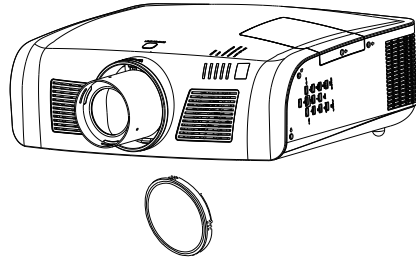

Clean the projector lens

Unplug the AC power cord before cleaning.

Gently wipe the projection lens with a cleaning cloth that contains non-abrasive camera lens cleaner, or use a lens cleaning paper or commercially available air blower to clean the lens.

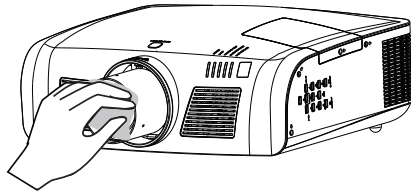

Avoid using an excessive amount of cleaner. Abrasive cleaners, solvents, or other harsh chemicals might scratch the surface of lens.

Clean the cabinet

Unplug the AC power cord before cleaning.

Gently wipe the projector surface with a soft dry cleaning cloth. When the cabinet is heavily soiled, use a small amount of mild detergent and finish with a soft dry cleaning cloth. Avoid using an excessive amount of cleaner. Abrasive cleaners, solvents, or other harsh chemicals might scratch the surface of the cabinet.

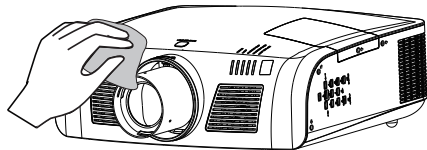

When the projector is not in use, put the projector in a pouch to protect it from dust and scratches.

Replace the lamp

When the projection lamp of the projector reaches its end of life, the Lamp replacement icon appears on the screen and LAMP indicator lights yellow. Replace the lamp with a new one of the same type promptly. The timing when the LAMP indicator should light is depending on the lamp mode.

Indicator

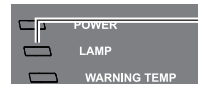

Lamp icon

When the projection lamp of the projector reaches its end of life, LAMP indicator lights yellow.

Lamp Replace



CAUTION

As temperature inside the projector is high, you should cool the projector for at least 45 minutes before you open the lamp cover.



CAUTION

When the lamp isn't illuminated, it may indicate that the lamp has been damaged.

When you replace the lamp in a projector installed on the ceiling, you should stand beside the lamp cover other than under it; for the broken glass may fall down to hurt you. To do that, remove the lamp cover gently to avoid being hurt by the dropped glass. If glass drops into your eyes or mouth, you should see the doctor immediately.



CAUTION

For the sake of safety, only use the lamp of the same model. Never drop the lamp onto the ground nor touch the glass bulb! The glass can shatter and hurt.

To replace the lamp, follow the steps below:

1. Power off the projector and unplug the power cord. Then let the projector cool for at least 45 minutes.
2. Loosen the screws on the lamp cover and open the cover.
3. Make sure the lamp is well protected and remove three screws. Hold the handle and take out the lamp.
4. Install a new lamp with the same model and tighten the three screws. Make sure the installation is correct. Put lamp cover in place and then tighten the screws.
5. Plug the AC power cord and power on the projector.

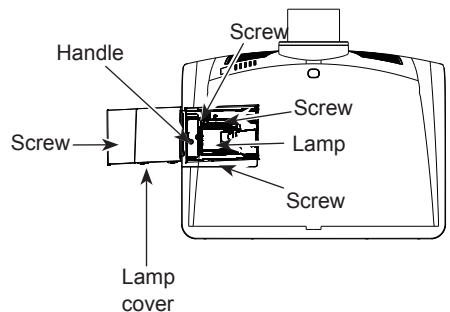

Maintenance and cleaning

Resetting the Lamp Counter

Be sure to reset the Lamp counter after the lamp is replaced. When the Lamp counter is reset, the LAMP REPLACE indicator stops lighting and the Lamp replacement icon disappears.

- 1 Press the MENU button to display the On-Screen Menu. Press ▲▼ buttons to select Setting icon and then press ► or the SELECT button.
- 2 Press ▲▼ buttons to select LAMP counter reset and then press SELECT button. Lamp replacement counter Reset? appears. Select Yes to continue.
- 3 Another confirmation dialog box appears, select Yes to reset the Lamp counter.

√ **Note:**

Do not reset the Lamp counter without implementing lamp replacement. Be sure to reset the Lamp counter only after replacing the lamp.

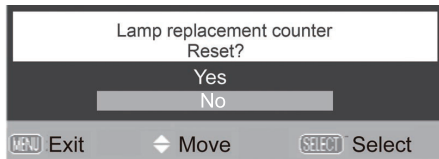
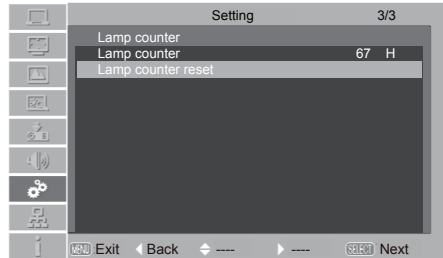

Replacement Lamp Type

ORDER REPLACEMENT LAMP

Replacement lamp can be ordered through your dealer. When ordering a projection lamp, give the following information to the dealer.

Model No. of your projector: LC-XN200, LC-WXN200, LC-XN200L, LC-WXN200L



LAMP HANDLING PRECAUTIONS

This projector uses a high-pressure lamp which must be handled carefully and properly. Improper handling may result in accidents, injury, or create a fire hazard.

- Lamp life may differ from lamp to lamp and according to the environment of use. There is no guarantee of the same life for each lamp. Some lamps may fail or terminate their life in a shorter period of time than other similar lamps.
- If the projector indicates that the lamp should be replaced, i.e., if the LAMP REPLACE indicator lights up, replace the lamp with a new one IMMEDIATELY after the projector has cooled down. (Follow carefully the instructions in the Lamp Replacement section of this manual.) Continuous use of the lamp with the LAMP REPLACE indicator lighted may increase the risk of lamp explosion.
- A Lamp may explode as a result of vibration, shock or degradation as a result of hours of use as its lifetime draws to an end. Risk of explosion may differ according to the environment or conditions in which the projector and lamp are being used.

IF A LAMP EXPLODES, THE FOLLOWING SAFETY PRECAUTIONS SHOULD BE TAKEN .

If a lamp explodes, disconnect the projector's AC plug from the AC outlet immediately. Contact an authorized service station for a checkup of the unit and replacement of the lamp. Additionally, check carefully to ensure that there are no broken shards or pieces of glass around the projector or coming out from the cooling air circulation holes. Any broken shards found should be cleaned up carefully. No one should check the inside of the projector except those who are authorized trained technicians and who are familiar with projector service. Inappropriate attempts to service the unit by anyone, especially those who are not appropriately trained to do so, may result in an accident or injury caused by pieces of broken glass.

Appendix

Troubleshooting

Before calling your dealer or service center for assistance, check the items below once again.

- Make sure you have properly connected the projector to peripheral equipment.
- Make sure all equipment is connected to the AC outlet and the power is turned on.
- If the projector does not project an image when it is connected to a PC, restart the PC.

Problems	– Solutions
No power	<ul style="list-style-type: none">- Plug the power cord of the projector into the AC power outlet.- Check whether the power indicator turns red.- Only when the power indicator turns red then you can power on the projector again.- Check the Warning Temp indicator. If it is blinking red, you can't power on.(P58)- Check the projection lamp.(P61)- Unlock the "key lock" function.(P55)
No initial displaying	<ul style="list-style-type: none">- Make sure both Display and count-down functions are enabled.(P50,P53)
Initial displaying is inconsistent with factory defaults	<ul style="list-style-type: none">- Make sure the item Default or Off is not selected in Logo select.(P51)
Input signals are automatically switched (can't be switched)	<ul style="list-style-type: none">- Adjust the search function of input source properly.
When input is pressed during startup, a filter icon appears.	<ul style="list-style-type: none">-This icon warns that the filter needs to be replaced.
An icon of non-input mode or lamp mode appears	<ul style="list-style-type: none">-This icon indicates the replacement of lamp or warns for the filter.
Ambiguous images	<ul style="list-style-type: none">- Adjust the focus.- Set a more proper projection distance.- Check whether the lens needs to be cleaned.- When moved from a environment with low temperature to the one with higher temperature, water will be condensed on the lens. If so, you have to wait till the condensed water disappears.
Image turns over leftward/ rightward Image turns over upward/ downward	<ul style="list-style-type: none">- Check the function of "ceiling/rear".(P52)- Check the function of "ceiling".
Image not bright enough	<ul style="list-style-type: none">- Check whether the contrast or brightness is adjusted correctly.(P40,46)- Check whether the image mode is properly selected.(P39,45)- Check the function of lamp brightness adjusting.(P54)- Check the lamp replace indicator. If the indicator is illuminated, it means the service life of the lamp is over. You should replace the lamp with a new one of the same model immediately.
No image	<ul style="list-style-type: none">- Check the connection between PC or video equipment with the projector.- Check whether the signal from PC is correct. If connected to certain laptops, the settings of their monitors need to be changed.You can refer to the operating instructions of the PC for such modification.- Images can show up only about 20 seconds after the projector is powered on.- Check the input signal, color system, video system or PC system mode.- Make sure that the temperature doesn't exceed the permitted operating temperature (41°F–95°F [5°C–35°C]).- If blank function is enabled, no image will appear on the screen. You can then press BLANK key or other keys.(P33)

Problems	– Solutions
Abnormal color	<ul style="list-style-type: none"> - Check the input signal, color system, video system or PC system mode. - Make sure the blackboard(green) is not selected in the item “Image select”.
Some information can't be seen in the operation.	<ul style="list-style-type: none"> - Check the function of display.
Automatic adjustment through PC can't be effective.Auto PC Adjustment is available only in analog signal	<ul style="list-style-type: none"> - Check the signal of input source. Automatic adjustment through PC won't be effective when 480p, 575p, 720p,480i, 575i, 1035i or 1080i is selected.
Settings can't be saved after the system is powered off.	<ul style="list-style-type: none"> - Make sure you have selected “store” after you changed the settings. Some settings can't be saved if “store” is not selected.
Ineffective power control	<ul style="list-style-type: none"> - When the system is standstill, or no-display function is enabled, the power control is ineffective.
Ineffective icon selection	<ul style="list-style-type: none"> - Check the wiring and the signal of input source, and make sure there is signal.
Ineffective automatic setting	<ul style="list-style-type: none"> - Make sure all functions in automatic setting are enabled. - Make sure the function of ceiling is not enabled.
Distorted image or no image	<ul style="list-style-type: none"> - Check and adjust the PC menu or on-screen menu.
The PIN code dialog box popes up in the startup process	<ul style="list-style-type: none"> - A PIN code is set for locking.
Remote control doesn't work	<ul style="list-style-type: none"> - Check the battery. - Make sure there is no obstacle between the projector and the remote control. - To use the remote control, keep it within 5 meters away from the projector. - Make sure the code of the remote control is consistent with the projector. - Unlock the key through the setup menu.
The indicator is illuminated or flashes	<ul style="list-style-type: none"> - Check the state of the projector according to the indicator.
Exclamatory mark appears on the screen	<ul style="list-style-type: none"> - Ineffective operation. You should operate the system correctly.
The side control panel doesn't work	<ul style="list-style-type: none"> - Unlock the keys on the side control panel through the item “security” in the setup menu.
PIN code lock for startup animation, key lock and PIN code lock can't be unlocked.	<ul style="list-style-type: none"> - Contact the local distributor or the repair center.

Warning:

High voltages are used to operate this projector. Do not attempt to open the cabinet.

If problems still persist after following all operating instructions, contact the dealer where you purchased the projector or the service center. Specify the model number and explain about the problem. We will advise you how to obtain service.

Appendix

Indicator and projector state

Check the indicator to know about the state of projector.

Indicator					State of projector
POWER RED/GREEN	LAMP GREEN	LAMP REPLACE YELLOW	WARNING TEMP RED	WARNING FILTER RED	
●	●	●	●	●	In power-off state (AC power cord not inserted).
○	○	-	●	-	In normal working state.
◐	●	-	●	-	In standby state. Press POWER to power on the projector
◑	●	-	●	-	Ready to get in standby mode or the projection lamp is being cooled. Before you power on the projector, you should wait till the lamp is cool enough and the power indicator stop flashes.
◑	●	-	●	-	In Power manage state.
◐	●	-	◑	-	Internal temperature is too high. Can't be powered on.
◐	●	-	◑	-	When the internal temperature of projector is restored to the normal value, the power indicator is illuminated red, and you can power on the projector. Meanwhile, the indicator Warning Temp stops flashing.
-	-	◐	-	-	The service life of the lamp is over. You should replace it with a new one in time.
◑	◑	◑	◑	◑	Can't be powered on because error is detected. You should unplug the power cord. Then insert it again and power on the projector. If the projector is powered off again, you should cut off the power and contact the local distributor or repair center. In this case, stop the projector. Otherwise, electric shock or fire may occur.
-	-	-	-	◐	Filter cleaning counter reach the time

○ ...Green ◐ ...Red ◑ ...Yellow - ...Normal operating

◑ ...Flash green ◑ ...Flash red ◑ ...Flash yellow ● ...Off

**When the projection lamp reaches its end of life, LAMP REPLACE indicator lights yellow.
Please replace the lamp with a new one.*

Compatible computer specifications

This projector can receive all analog computer formats that DCLK less than 160MHz and digital computer formats that DCLK less than 140MHz.

Detailed resolution and corresponding field frequency are listed in the following table.

Input source	Signal format	Resolution	Field Frequency (Hz)
PC	VGA	640x480	60Hz
	VGA	640x480	68Hz
	VGA	640x480	72Hz
	VGA	640x480	75Hz
	VGA	640x480	85Hz
	SVGA	800x600	56Hz
	SVGA	800x600	60Hz
	SVGA	800x600	72Hz
	SVGA	800x600	75Hz
	SVGA	800x600	85Hz
	MAC 16	832x624	75Hz
	XGA	1024x768	60Hz
	XGA	1024x768	70Hz
	XGA	1024x768	75Hz
	XGA	1024x768	85Hz
	XGA+	1152x864	75Hz
	WXGA	1280x768	60Hz
	WXGA	1280x768	75Hz
	WXGA	1280x768	85Hz
	WXGA	1280x800	60Hz
	WXGA	1280x800	75Hz
	WXGA	1280x800	85Hz
	WXGA	1366x768	60Hz
	QVGA	1280x960	60Hz
	QVGA	1280x960	85Hz
	SXGA	1280x1024	60Hz
	SXGA	1280x1024	75Hz
	SXGA	1280x1024	85Hz
	SXGA+	1400x1050	60Hz
	SXGA+	1400x1050	75Hz
UXGA	1600x1200	60Hz	
WSXGA+	1680x1050	60Hz	
WUXGA	1920x1200	60Hz	
Component	480i	720x480i	60Hz
	576i	720x576i	50Hz
	483p	720x483p	60Hz
	576p	720x576p	50Hz
	720p	1280x720	50Hz
	720p	1280x720	60Hz
	1080i	1920x1080i	50Hz
	1080p	1920x1080i	60Hz

Input source	Signal format	Resolution	Field Frequency (Hz)
HDMI	VGA	640x480	60Hz
	VGA	640x480	68Hz
	VGA	640x480	72Hz
	VGA	640x480	75Hz
	VGA	640x480	85Hz
	SVGA	800x600	56Hz
	SVGA	800x600	60Hz
	SVGA	800x600	72Hz
	SVGA	800x600	75Hz
	SVGA	800x600	85Hz
	MAC 16	832x624	75Hz
	XGA	1024x768	60Hz
	XGA	1024x768	70Hz
	XGA	1024x768	75Hz
	XGA	1024x768	85Hz
	XGA+	1152x864	75Hz
	WXGA	1280x768	60Hz
	WXGA	1280x768	75Hz
	WXGA	1280x768	85Hz
	WXGA	1280x800	60Hz
	WXGA	1280x800	75Hz
	WXGA	1280x800	85Hz
	WXGA	1366x768	60Hz
	QVGA	1280x960	60Hz
	QVGA	1280x960	85Hz
	SXGA	1280x1024	60Hz
	SXGA	1280x1024	75Hz
	SXGA	1280x1024	85Hz
	SXGA+	1400x1050	60Hz
	SXGA+	1400x1050	75Hz
UXGA	1600x1200	60Hz	
WSXGA+	1680x1050	60Hz	
WUXGA	1920x1200	60Hz	
Video/S-video	NTSC	NTSC	-
	PAL	PAL	-
	SECAM	SECAM	-

√ Note:

The specification is subject to change without any prior notice.

Appendix

Menu Tree

HDMI Input/VGA Input//Component Input/S-video Input/Video Input/ RGBHV Input/Network Input/Image Viewer Input/USB Autorun Input

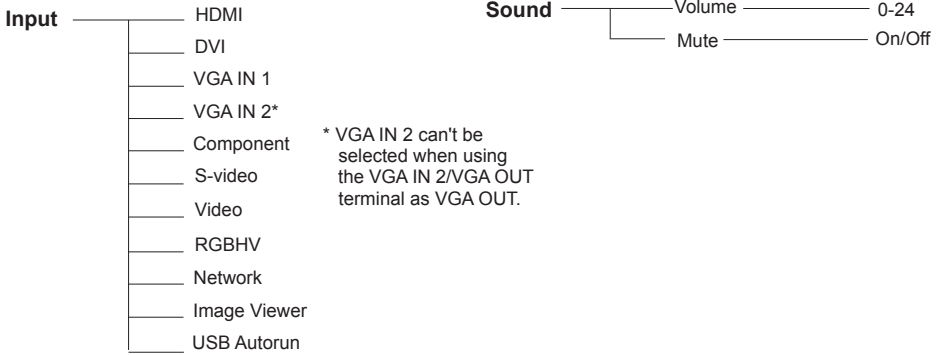

VGA Input/HDMI Input/RGBHV Input/Network Input/ Image Viewer Input/USB Autorun Input

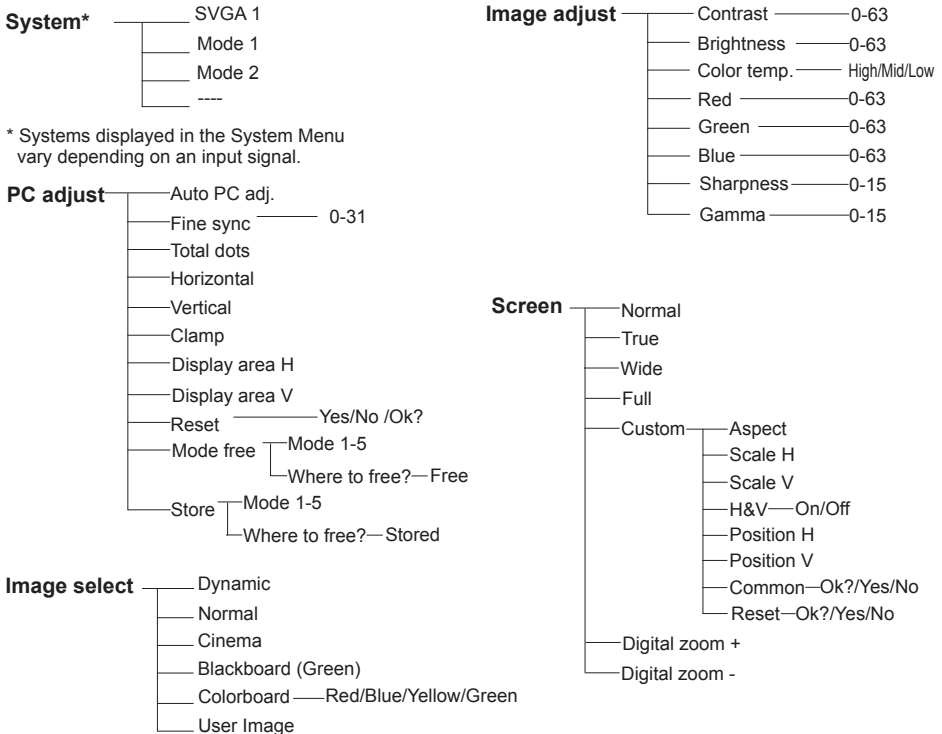

Component Input/S-video Input/Video Input

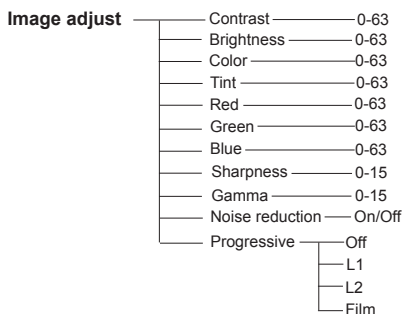
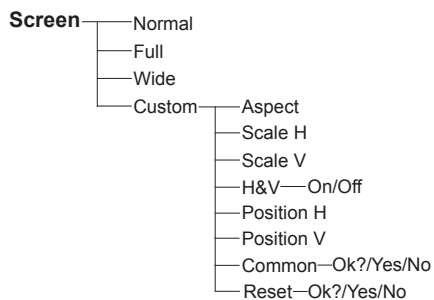
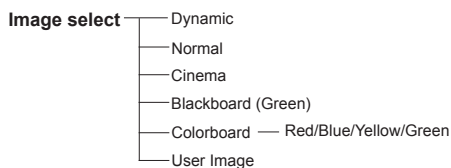
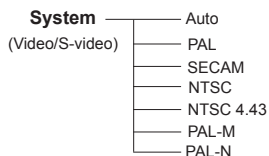
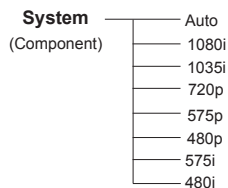

Appendix

HDMI Input/VGA Input/Component Input/S-video Input/Video Input/ RGBHV Input/Network Input/Image Viewer Input/USB Autorun Input

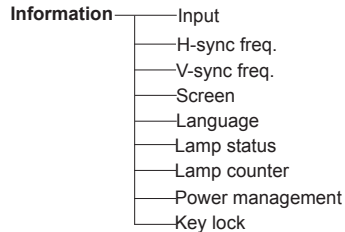
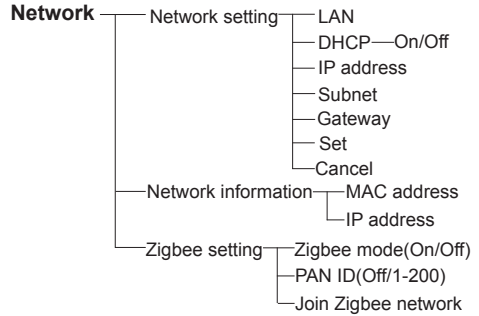
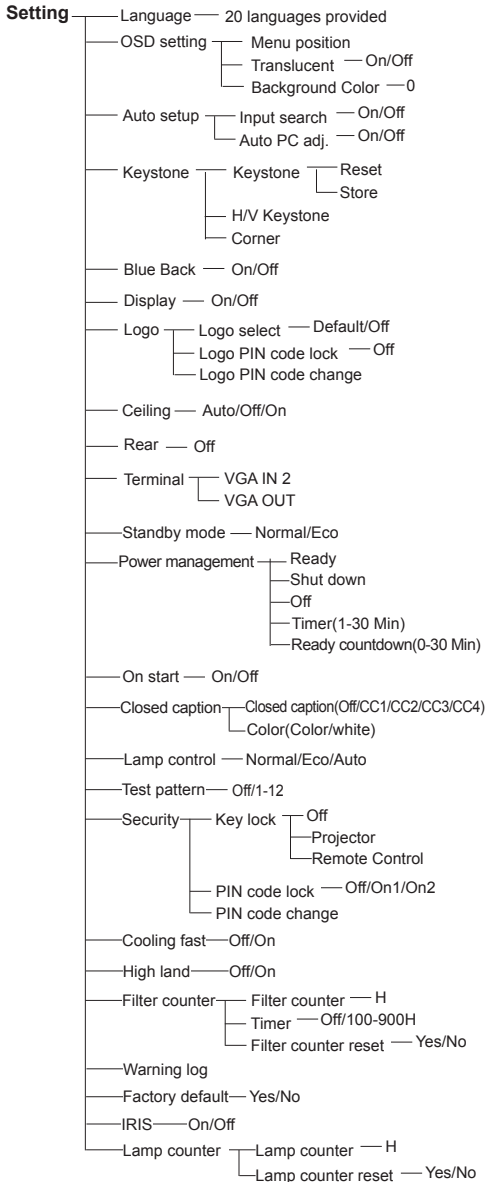

Technical Specifications

Mechanical properties

Dimensions (W×H×D)	535mmx465mmx191mm
Net Weight	10.6Kg (with Lens) / 9.69Kg (without Lens)
Adjustable foot	5'

LCD resolution

LCD system	0.79" TFT, active matrix, 3-panel (LC-XN200, LC-XN200L) 0.75" TFT active matrix, 3-panel (LC-WXN200, LC-WXN200L)
LCD resolution	1024X768 (LC-XN200, LC-XN200L) / 1280X800(LC-WXN200, LC-WXN200L)

Compatible signals

Color standard	PAL, SECAM, NTSC, NTSC4.43, PAL-M and PAL-N
HDTV signal	480i, 480p, 575i, 575p, 720p, 1035i, 1080i and 1080p
Scanning frequency	Horizontal frequency: 15 kHz–100 KHz; Vertical frequency: 50–120 Hz

Optical elements

Image size (diagonal lines)	40"-300", adjustable
Projection distance	4:3 1.38m-10.36m(W) 2.35m-17.62m(T)
Lens	16:10 1.30m-10.10m(W) 2.20m-17.20m(T) F=1.7-2.3, f=27.7-45.5mm; Electric zooming and focusing; Zoom times: 1.7
Lamp power	350W (Normal)/264W(ECO)
Contrast Ratio	2000:1
Aspect Ratio	4:3 (LC-XN200, LC-XN200L) / 16:10 (LC-WXN200, LC-WXN200L)

Terminal

S-Video	S-Video Mini Din 4pin x1
BNC/VIDEO terminal	BNC x 5 (G or Video/Y, B or Pb/Cb, R or Pr/Cr, HV and V)
VGA IN 1 terminal	Mini D-sub 15 pin x1
VGA IN 2/MONITOR OUT terminal	Mini D-sub 15 pin x1
DVI terminal	Digital (DVI-D) 24 pin x1
HDMI terminal	HDMI A type 19 pin (the number of HDMI terminals varies from model to model. See the real product.)
AUDIO IN	USB-Ax1 / USB-Bx1
Wired remote control input terminal/	3.5mm Mini Type Stereo x1
Wired remote control output terminal	Mini Jack x2
CONTROL terminal	D-sub 9 pin x1
LAN terminal	100 Base-TX (100Mbps)/10 Base-T (10Mbps), RJ45

Power

Voltage and power consumption	AC 100–240 V (Max 7A), 50/60 Hz
Fuse	10A/250V
Internal audio AMP	7W * 1, single channel
Internal speaker	10W RMS 8ohm, *1

Operating Environment

Operating temperature	41°F-95°F (5°C-35°C)
Storage Temperature	14°F-140°F (-10°C-60°C)
High land	2000 m

Remote control

Battery	AA or LR6 1.5V ALKALINE TYPE x 2
Operating Range	16.4' (5 m)±30
Dimensions	48mm (W) x 26mm (H) x 160mm (D)
Net Weight	67g (including batteries)

Accessories

Owner's Manual(CD)	WiFi Dongle
Quick Start Guide	Zigbee Antenna
Remote control and batteries	Zigbee Dengele
AC power cord (US Type x 1 / Euro Type x 1)	Rubber gaskte
Rubber Cap	
VGA cable	

*(Optional lens please see the next page in detail)

- The aforesaid specification is subject to change without prior notice.
- Liquid crystal panel is made on the basis of high standard, where 99.99% of the pixels are effective. Due to the nature of the liquid crystal panel, a fraction of the pixels (0.01% or less) may be ineffective.

Appendix

	Short Lens	Short Zoom Lens	Standard Lens	Long Zoom Lens	Long Zoom Lens
Part No.	AH-24721	AH-24711	AH-24741	AH-24771	AH-24781
Code	LNS-W21	LNS-W20	LNS-S20	LNS-T20	LNS-T21
Power or Manual	Fixed	Power zoom	Power zoom	Power zoom	Power zoom
Iris (F)	2	1.8-2.3	1.74-2.37	1.82-2.34	1.83-2.35
Focal Length (f)	13.05	20.35-27.66	26.85-45.43	45.6-73.8	73.9-117.1
Throw distance ratio	0.8:1	1.25-1.70	1.70-2.89	2.89-4.60	4.60-7.36
Lens shift U/D	0% (Fixed)	±50% (Powered)	±50% (Powered)	±50% (Powered)	±50% (Powered)
Lens shift R/L	0% (Fixed)	±10% (Powered)	±10% (Powered)	±10% (Powered)	±10% (Powered)
Max diameter	108mm	115mm	108mm	108mm	108mm
Length	135.9mm	165.5mm	145.7mm	169.6mm	166.0mm
Weight	1.08Kg	1.2Kg	0.85Kg	1.18Kg	1.2Kg

Configurations of terminals

VGA IN 1/VGA IN 2/VGA OUT (Analog)

Terminal: Analog RGB (D-sub 15 pin)

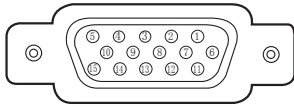

1	Red (Input/Output)	9	-----
2	Green (Input/Output)	10	Ground (field synchronizing)
3	Blue (Input/Output)	11	Ground
4	-----	12	DDC data
5	Ground (line synchronizing)	13	Horizontal synchronizing (compound sync.) Input/output
6	Ground (red)	14	Vertical synchronizing Input/output
7	Ground (green)	15	DDC Clock
8	Ground (blue)		

RS232 terminal (D-SUB-9 pin)

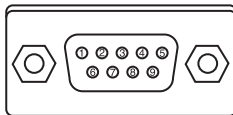

1	-----
2	RXD
3	TXD
4	-----
5	GND
6	-----
7	-----
8	-----
9	-----

LAN terminal

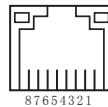

1	TX +	5	-----
2	TX -	6	RX -
3	RX +	7	-----
4	-----	8	-----

HDMI terminal (HDMI Type A 19 pin)

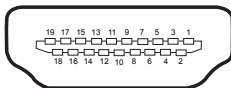

1	TMDS Data2+	11	TMDS Clock Shield
2	TMDS Data2 Shield	12	TMDS Clock-
3	TMDS Data2-	13	CEC
4	TMDS Data1+	14	Reserved (N.C. on device)
5	TMDS Data1 Shield	15	SCL
6	TMDS Data1-	16	SDA
7	TMDS Data0+	17	DDC/CEC Ground
8	TMDS Data0 Shield	18	+5V Power
9	TMDS Data0-	19	Hot Plug Detect
10	TMDS Clock+		

DVI terminal (DVI-D, 24 pin)

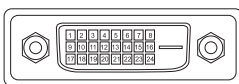

1	TMDS Data 2-	9	TMDS Data 1-	17	TMDS Data 0-
2	TMDS Data 2+	10	TMDS Data 1+	18	TMDS Data 0+
3	TMDS Data 2 Shield	11	TMDS Data 1 Shield	19	TMDS Data 0 Shield
4	-----	12	-----	20	-----
5	-----	13	-----	21	-----
6	DDC Clock	14	+5V Power	22	TMDS Clock Shield
7	DDC Data	15	Ground (for +5V)	23	TMDS Clock +
8	-----	16	Hot Plug Detect	24	TMDS Clock -

USB-B terminal

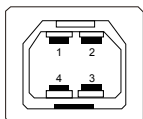

1	V Bus
2	Data -
3	Data +
4	GND

S-VIDEO(4 pin)

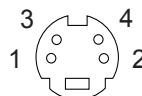

1	CND	Y brightness_GND
2	CND	C color_GND
3	Y	Brightness
4	C	Color

Appendix

Content of hazardous substances and elements

Name of parts		Hazardous substances and elements					
		Pb	Hg	Cd	Cr6+	PBB	PBDE
Body	Plastic parts	○	○	○	○	○	○
	Metal parts	○	○	○	○	○	○
	Optical parts	×	×	○	○	○	○
	PCB assembly	○	○	○	○	○	○
	Other parts	×	○	○	○	○	○
Accessories	Remote control	×	○	○	○	○	○
	Cable	×	○	○	○	○	○

○: It means that contents of hazardous substances in all homogeneous materials in this part don't exceed "Required Limitations" specified in SJ/T11363-2006.
 ×: It means that contents of hazardous substances in at least one homogeneous material in this part exceed "Required Limitations" specified in SJ/T11363-2006.

Dimensions

Unit: mm

↘ Screw Holes for Ceiling Mount
 Screw: M6
 Depth: 10.0

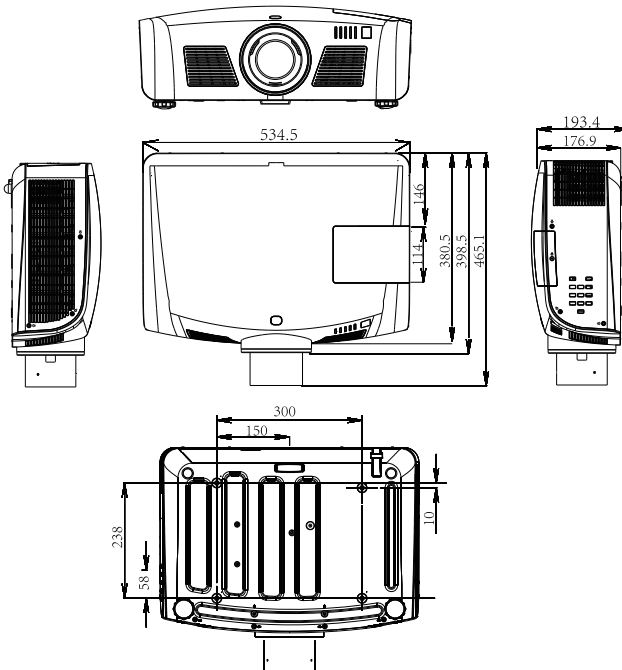

PIN code memorandum

Write down the PIN code number in the column below and keep it with this manual securely. If you forgot or lost the number and unable to operate the projector, contact the service center.

PIN code lock

Factory default PIN code 111*

--	--	--

Locking startup-animation PIN code

Factory default PIN code 111*

--	--	--

*If this 3-digit number is changed, the factory default number will be ineffective.

Network Control Instructions

LAN control

Function : PC controls projector via LAN.

Preparation:

1. Equipments: PC, projector, LAN cables
2. Connection procedures:

Connect the projector to routers or switches of the LAN by direct or cross cable. If it fails to connect PC and projector by parallel cable, please switch to cross cable as suggested.

3. After the computer is booted and the projector is plugged in, indicator lights of LAN interface and computer interface will flash continuously.

Operation procedures:

- 1 Turn on the projector.
- 2 Obtain network address. DHCP set is displayed as on and obtain network address automatically. If familiar with network, you can set DHCP as close and obtain network address manually.
- 3 Enter network settings menu.

- (1) Press MENU button on side control or remote control to display screen menu. Press ▲▼ button to select network icon.

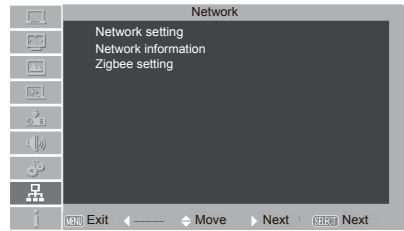

- (2) Press SELECT button on the side control panel or ► button on the remote control to enter the network setting.

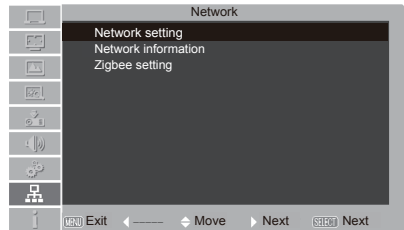

- (3) Press ▲▼ button to select Network settings and press OK/SELECT button.
- (4) Press ▲▼ button to set DHCP as on.
- (5) Press ▲▼ button to "Set" and press OK/SELECT button. "Please wait..." appears.

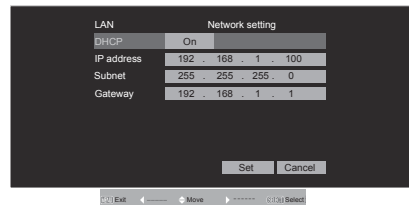

✓ Note:

- When connecting to wireless network, please check the SSID/ ESSID and IP address in "Network information".
- WIFI does not support hot plug, do not plug WIFI at boot time.

Network Control Instructions

4 Check IP address

Enter network menu and select network information. Press OK button to check IP address.

5 Input the IP address into the address bar.

Format: http:// IP address/.

(If wireless network is used, please open the wireless connecting in computer, find the SSID displayed in "Network information", then input the IP address obtained from "Network information" into the address bar.)

6 Settings in network management: Projector Information, LAN Setting, Projector Status and Control, E-mail setting and Security setting.

Projector Information: To view the current state of the network and information of projector.

√ Note:

This projector is compatible with Crestron Room View® and AMX Device Discovery System.

**Crestron is a registered trademark of Crestron Electronics, Inc.*

**AMX is a registered trademark of AMX LLC.*

If you set a password, the interface is shown as follows:

The screenshot shows the 'Web Management' interface with a sidebar on the left containing navigation links: Projector Information (selected), LAN Setting, Projector Status and Control, E-mail Setting, and Security Setting. The main content area is titled 'Projector Information' and displays the following details:

Model Name:	LW8000+
Projector Name:	D63297
Location:	
Contact:	
Status:	Lamp ON
Lamp Hours:	42 hr
Operation Hours:	42 hr
IP Address:	192.168.1.15
MAC Address:	00:60:EB:07:F7:41
Admin Password:	Not Set!

At the bottom, there is a 'Language' dropdown menu set to 'English' and a 'Submit' button.

The screenshot shows the 'Web Management' interface with a 'Welcome to Web Management.' message. Below the message is an 'Administrator Password:' field with a masked password (●●●●) and a 'Login' button.

Projector Information
Projector Name: D63297
IP Address: 192.168.1.15

LAN Setting: Modify the network configuration parameters.

The screenshot shows the 'Web Management' interface with a sidebar on the left containing navigation links: Projector Information, LAN Setting (selected), Projector Status and Control, E-mail Setting, and Security Setting. The main content area is titled 'LAN Setting' and displays the following configuration options:

Model Name:	LW8000+
Projector Name:	D63297
Location:	
Contact:	

Below these fields is a 'Save' button. The network configuration section has two radio buttons: 'DHCP' (unselected) and 'Manual' (selected). The 'Manual' configuration includes the following fields:

IP Address:	192.168.1.15
Subnet Mask:	255.255.255.0
Gateway:	192.168.1.1
DNS:	0.0.0.0

Each of these fields has a 'Save' button. The 'Crestron Control System Device' section includes the following fields:

Crestron Control System Device	
IP Address:	255.255.255.255
Device ID:	7
Port:	41794

Each of these fields has a 'Save' button.

Network Control Instructions

Projector status and control: For the current view state and control of the projector.

The screenshot shows the 'Projector Status and Control' page. On the left is a navigation menu with options: Projector Information, LAN Setting, Projector Status and Control (selected), E-mail Setting, and Security Setting. The main content area is titled 'Projector Status and Control'. It includes a 'Projector Status' section with a 'Refresh' button, 'Projector Status' (Sleep Off), 'Auto Power Off (Min)' (0), and 'Alert Status'. Below this is an 'Image Control' section with a 'Casting Mount' dropdown (Fixed), 'Input' (HDMI), 'Color Mode' (Dynamic), 'All Mode' (On), 'Freeze' (On), and 'Aspect Ratio' (Normal). There are also sliders for Brightness, Contrast, Color, Sharpness, Tint, Red, Green, and Blue, each with a 'Set' button. At the bottom is an 'Audio Control' section with 'Volume' (12) and 'Mute' (Off).

E-mail setting: Configure your email, so that the projector failure, to send a notification email.

The screenshot shows the 'E-mail Setting' page. The left navigation menu is the same as in the previous screenshot. The main content area is titled 'E-mail Setting'. It features an 'E-mail Alert' section with 'Enable' and 'Disable' radio buttons (Disable is selected) and an 'E-mail Alert Test' button. Below are input fields for 'TO', 'CC', 'From', and 'Subject'. The 'SMTP Setting' section has an 'Out going SMTP server' field. The 'Alert Condition' section has checkboxes for 'Lamp warning', 'Lamp life reminder', and 'Temperature warning', with a 'Save' button at the bottom.

Security setting: The user can modify the login password. (the default is no password status)

The screenshot shows the 'Security Setting' page in its initial state. The left navigation menu is the same. The main content area is titled 'Security Setting' and includes a warning: 'Please set your password if you enable this feature for first-time. If password is set, you will require to enter with your password upon you connect to the Web Management.' The 'Administrator' section has 'Enable' and 'Disable' radio buttons (Disable is selected) and a 'Submit' button. Below are input fields for 'Password', 'New Password', and 'Confirm Password', each with a 'Submit' button.

This screenshot shows the 'Security Setting' page with the password fields masked. The 'Administrator' section now has 'Enable' and 'Disable' radio buttons (Enable is selected) and a 'Submit' button. The 'Password', 'New Password', and 'Confirm Password' fields are now filled with dots, and each has a 'Submit' button.

Wireless LAN control [ProjectorMe]

Function: Project PC images on the screen using wireless network.



Wireless network setup:

1. Inset the supplied WIFI dongle into the USB-A port.

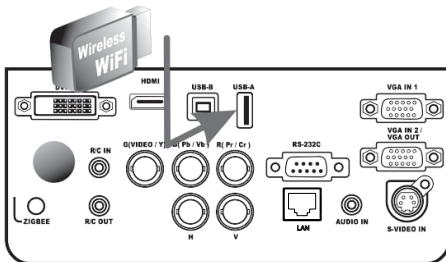

2. Please find "Network Display" and click "connect".

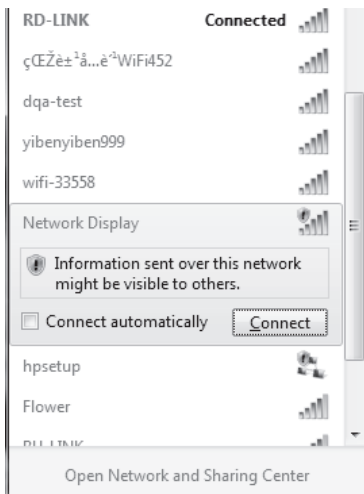

Network Control Instructions

ProjectorMe installation procedure:

1. Type the Wireless IP address of the projector in the address bar of the web browser.
(Please find the IP address from the Network information in the OSD.)

✓ *Note:* ProjectorMe only works on wireless network.

2. Click "Download".

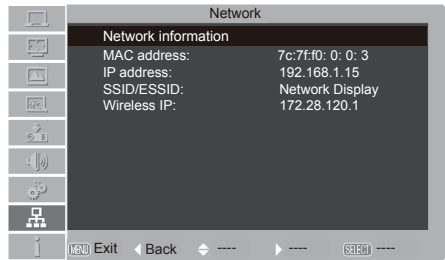
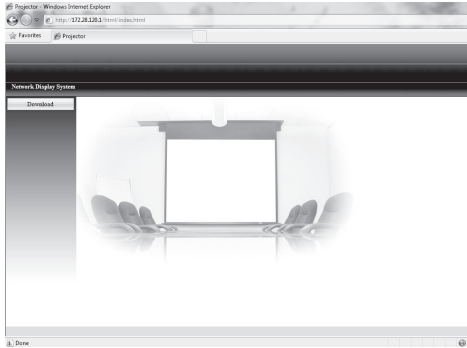

3. Click "Download". (Downloaded program can work with Windows7 without problem. Don't hesitate to click it with Windows7 PC.)

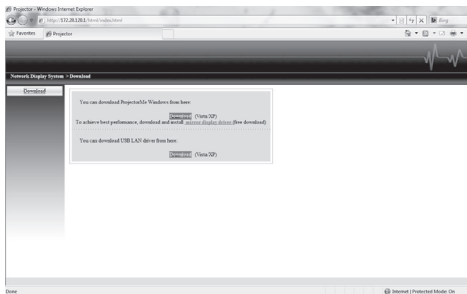

4. Click "RUN" to execute the program.

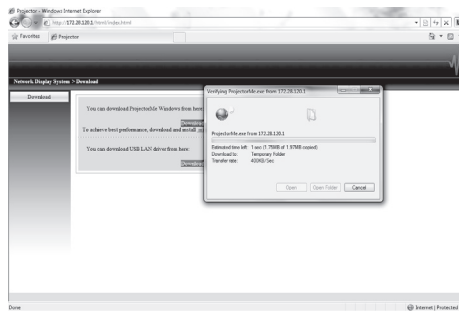
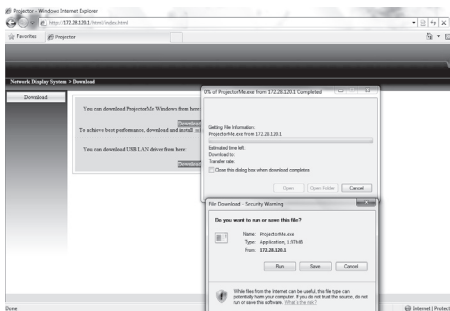

5. A message "Do you want to allow the following program to make changes to this computer?" will appear. Click "Yes". Then click "Next".

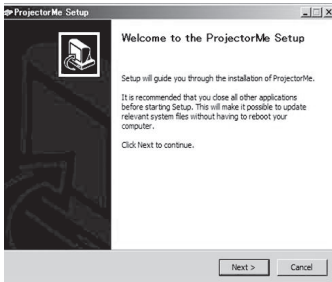

6. Click "I Agree".

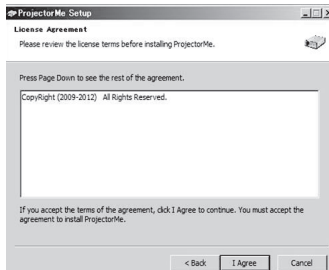

7. Click "Next".

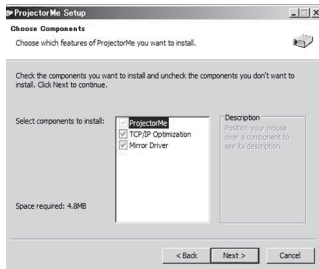

8. Click "Next".

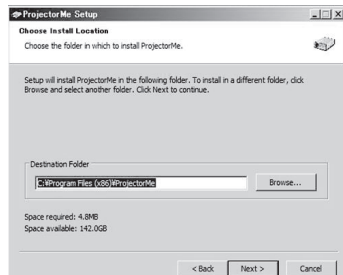

Network Control Instructions

9. Fill the name and password in the blank area, select the language, then click "Next".

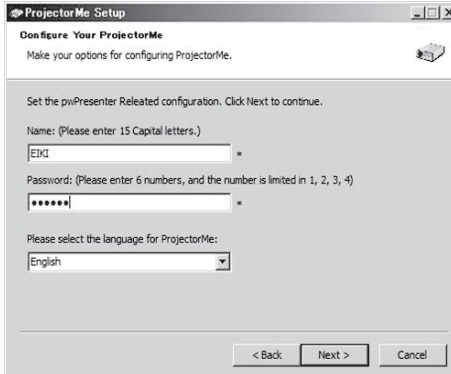

10. Click "Install" and wait till the installation has been done.

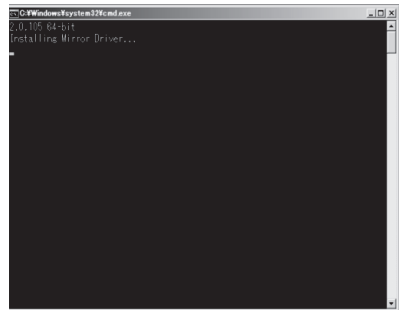
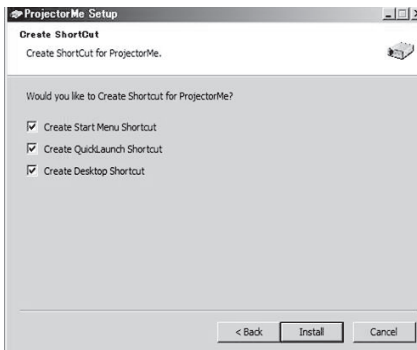

11. Click "Finish" to reboot the PC.
(End of insallation procedure)



Operation procedure:

1. Select "Network" as the input source on the projector.
2. Double-click "ProjectorMe" to launch the program.



3. Click "OK".

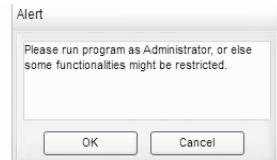

4. A message "Do you want to allow the following program to make changes to this computer?" will appear. Click "Yes".
5. ProjectorMe software will appear. Click "Search for projector".



6. Click "Search" to find available projectors automatically. (Or type the IP address in the blank area then click "Connect".)

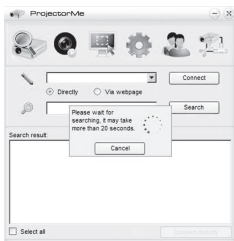

7. Click "OK".

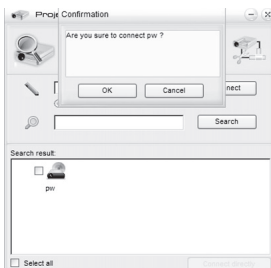

Network Control Instructions

8. Click "All", and then click "OK" to project the PC image on the screen.



✓Note: If fail to connect, please disable the firewall settings and try again.

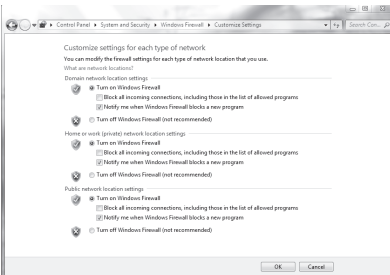
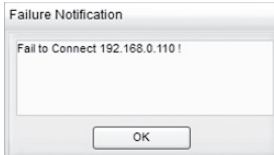

9. Click the cross button in the to right corner, then click "OK" to quit the program.
(End of operation procedure)

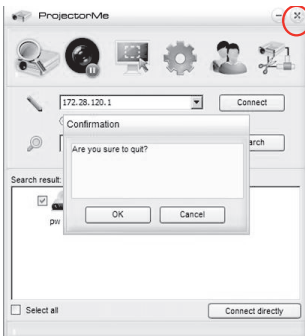

Icons in the tool bar

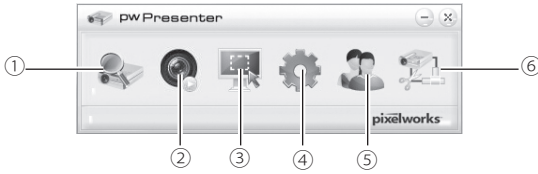

- ① Projector Search.
- ② Play / Pause
Play or pause the selected image.
- ③ Choose the capture mode
Set the capture mode from "FullScreen", "FixedSize" or "Alterable".



- ④ Parameters Setting
Basic Setting: Set language, region of capture image etc.
Advanced Setting: Set image quality, network port etc.

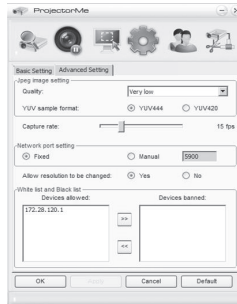
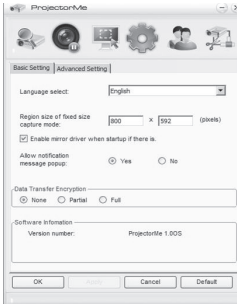

- ⑤ Network Display Management
Set device configurations and password.

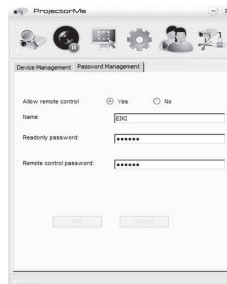
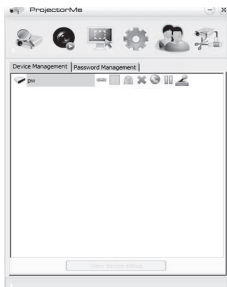

- ⑥ Disconnect the projector.

ZIGBEE Networking Instructions

ZIGBEE Networking

Function : Control the projector, KeyStone, LenzShift, Blending.

Preparation:

Equipments: PC 1 pcs, projector 1 pcs, ZIGBEE module 1 pcs, ZIGBEE antenna 1 pcs.

Computer configuration

■Note: For the first networking, you have to complete the PC configuration before power-on the projector. Such limitation will be disabled upon successful networking.

Please run as Administrator when operating in the WIN7 or WIN8 system.

1. Connect the zigbee antenna to the ZIGBEE port.
2. Insert the ZIGBEE module into PC, and a prompt appears in the lower right corner of the PC, as shown below:

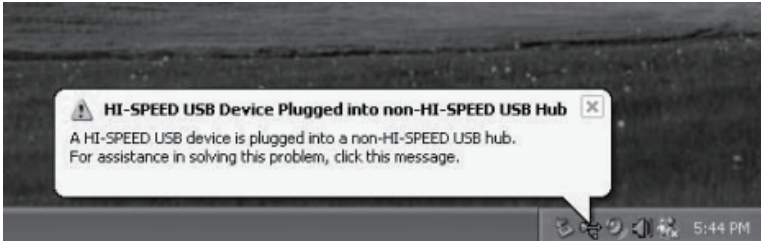

3. Install the driver, as shown below.

Open file "CP210x driver" in the CD ROM supplied with the projector, double-click "CP210xVCPInstaller.exe" under "CP210x driver" and click "Install" as below:

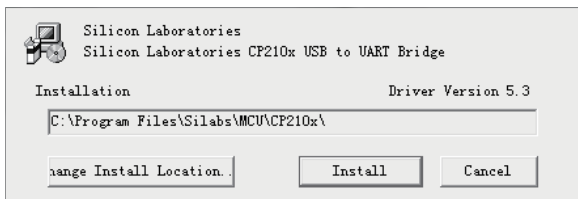

After clicking "Install", a prompt box of "Installation Successful" displays. Click OK and the driver installation is completed, as shown below:



4. Check COM port, click "My Computer", and click right button to select "Manage" as shown below:

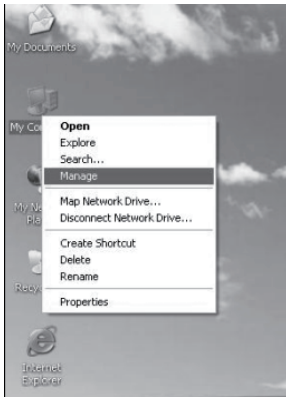

Open "Device Manager" to view "Port" item. A line of "Silicon Labs CP210x USB to UART Bridge (COM5)" appears. The COM5 is the port we are going to use.



5. Open file "projectorWLAN.exe" (If PC is Window7 or Window8 system, select "run as administrator" and "to compatibility mode"), a window shows as below:

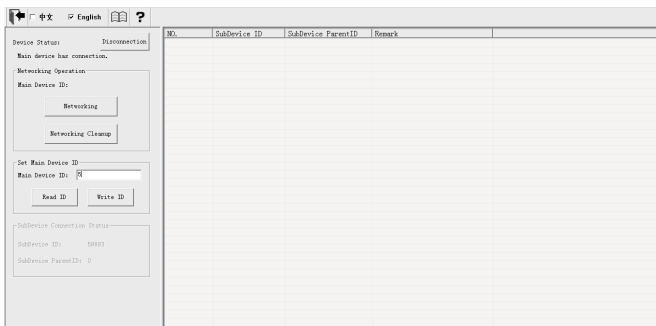

ZIGBEE Networking Instructions

- Power on the projector, press remote control or side control to find “Zigbee Setting” and press “OK” to enter.

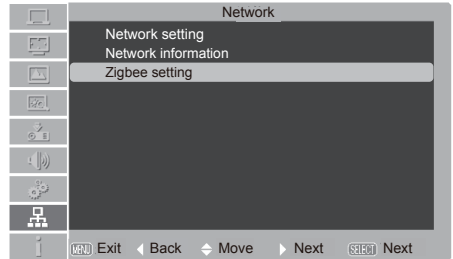

Set “Zigbee Mode” to “On”, and press “OK” button on remote control.

Set “PAN ID” to “7”, identical to the PC “PAN ID” and press “OK” button on remote control. If successful, the window will display "OK", otherwise it will display a red "NG".

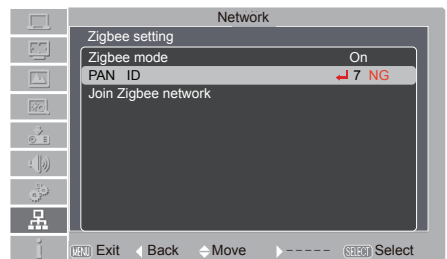
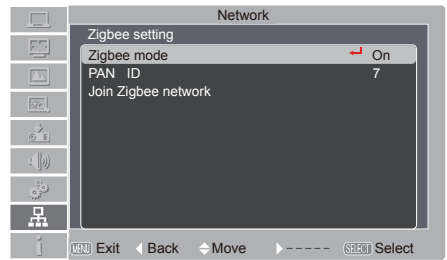

Connect network by selecting “Join Zigbee Network” in projector menu and pressing “OK” button on remote control

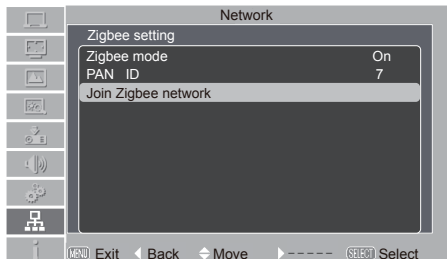

ZIGBEE Networking Instructions

After joining the network, a code will appear under "ID" item under the PC window, "28351" as shown below:

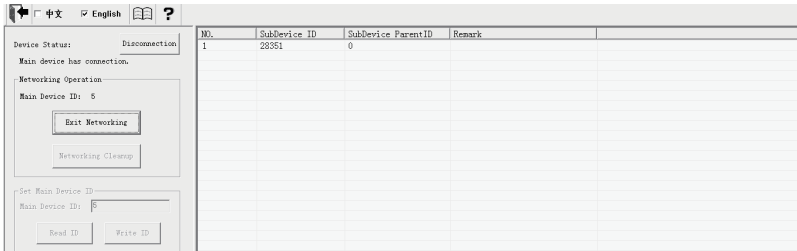

7. After successful networking, double click "28351" to perform such operations as "Standard, KeyStone, LenzShift and Blending", as shown below:

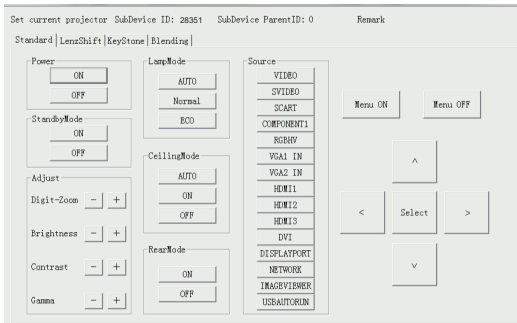

Standard:

- ① Adjust Digit-Zoom, Brightness, Contrast and Gamma.
- ② Control power-on/off.
- ③ Select LampMode, CeilingMode, RearMode, StandbyMode, Source.
- ④ Screen menu control.

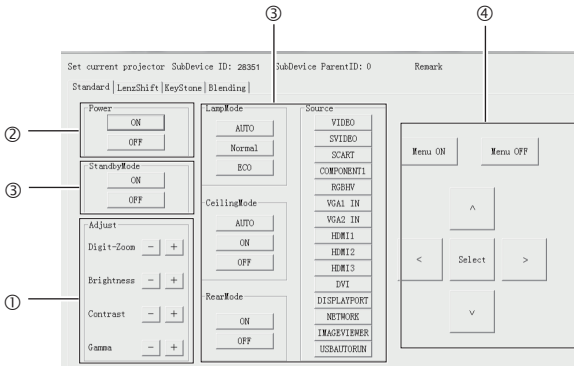

LenzShift:

- ① Control the projector lens shift upwards /downwards/leftwards and rightwards.
- ② Lens focus +/- adjust.
- ③ Lens zoom +/- adjust.

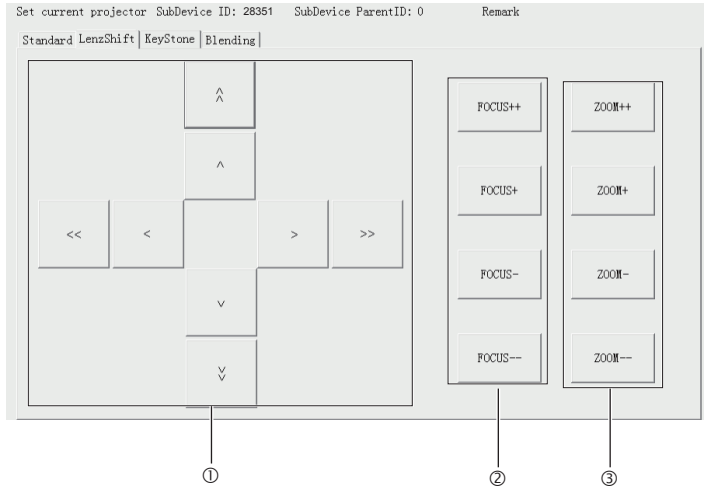

✓ Note:

- Lens Shift \uparrow \downarrow \leftarrow \rightarrow (slowly). Lens Shift $\hat{\uparrow}$ $\hat{\downarrow}$ $\hat{\leftarrow}$ $\hat{\rightarrow}$ (quickly).
- Focus +, Focus -, Zoom+, Zoom- (slowly). Focus++, Focus--, Zoom++, Zoom-- (quickly).
- Enter "LenzShift", when change the direction every time, please press "quickly" button first, then adjust "slowly" button.

KeyStone:

Perform keystone and corner correction.

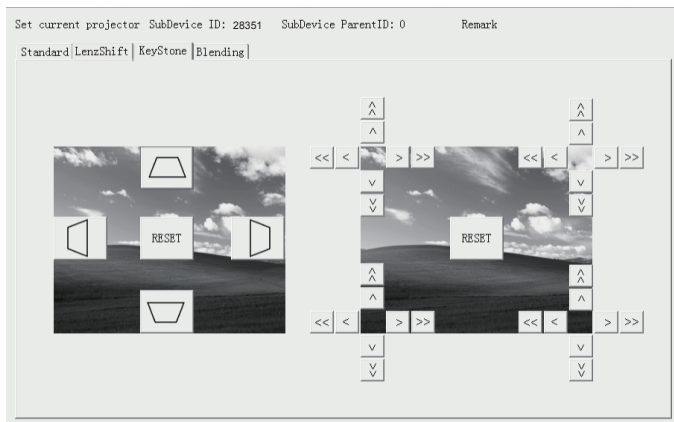

ZIGBEE Networking Instructions

Blending:

This function is used to set the items for screen blending.

Preparation:

Equipments: PC 1 pcs, the same model projector 2(n) pcs, ZIGBEE module 1 pcs, ZIGBEE antenna 2(n) pcs.

The screenshot shows a software window titled "Set current projector SubDevice ID: 28351 SubDevice ParentID: 0 Remark". The window has a tabbed interface with "Standard", "LenzShift", "KeyStone", and "Blending" tabs. The "Blending" tab is active. It contains several sections: "Set Splicing Number" with input fields for "Total number of H:" (value 2) and "Total number of V:" (value 1); "Set Parameter" with input fields for "Width of H-integration(0~400pixel):" (value 300), "Width of V-integration(0~300pixel):" (value 200), and "Gamma(0~γ):" (value 4), along with a "Welding line" checkbox and an "Advanced Gamma Set" button; "Set Local Position" with input fields for "H-Position:" (value 1) and "V-Position:" (value 1), and a "NO" dropdown menu with "1" selected; and three buttons at the bottom: "Reset", "Save and refresh basic fusion data", and "Save and refresh PW data".

Pattern HxV:

Indicates the number of projectors on Position H and Position V. For example: 2 projectors on Position H and 1 projector on Position V. Other number can be interpreted in this way too.

Local Position:

Indicates the place of this projector in Position H or Position V. For example, 2 projectors on Position H and 1 projector on Position V, We choose "1" in "Set Local Position No" of this projector to indicate that this projector is the first projector in horizontal direction.

Welding line:

The public projecting area for at least two projectors.

Width of V-integration:

Vertical integration with pixel width values are 0 to 300 pixels.

Width of H-integration:

It indicates the width of H-integration. Generally, input 300, subject to adjustment. The width ranges 0-400. The greater the value is, the wider the integration band will be. Take "2 projectors on Position H and 1 projector on Position V" blending (the right of the left projector image blending with the left of the right projector image). We choose "1" in "Set Local Position No" of this projector, and 300 in H-integration band width. It indicates that the right integration band width of the 1st projector in horizontal direction is 300; if we choose "2" in "Set Local Position No" of this projector, and 300 in horizontal integration band width, it indicates that the left integration band width of the 2nd projector in horizontal direction is 300.

Gamma:

It indicates the brightness and line fuzziness of the integration band. The value ranges from 0 to 7 subject to adjustment. The recommended value is 4.

R/G/B:

It indicates that the brightness of R, G and B may be adjusted. The value ranges from 0 to 1023. The greater the value is, the brighter it will be. This setting is used for adjusting the brightness difference between two or more than two projectors.

Note: After successful networking, it is no need to reset while use the projector after power is cut off. You only need to open file "projectorWLAN.exe".

Blending Debugging Setting

Here take two projectors as example to introduce the blending method.

1 Connect these two projectors by the aforesaid networking method (please refer to page 74-79). After successful connection, an interface as shown below appears under the PC window. Mark the left projector as "1" and the right projector as "2" in "Remark" column, as shown below. If you are not sure which one is the left one and which one is the right one, double click "28351" or "42852" in "ID" column to enter control interface. Press any key in that interface, and the projector will give corresponding reply. Doing so, you will be clear about which projector is the left one and which projector is the right one.

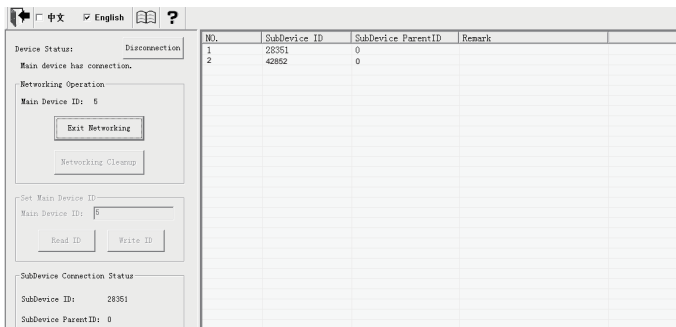

✓ Note:

- For the first projector, one end connected with computer through VGA IN 1, and the other end connected with the second projector through VGA IN 2/VGA OUT.
- Please set both of the two projector's "input source" are "VGA IN".
- When the first projector is networking successful, the second one only need set "Network". Set "PAN ID" to "5", identical to the PC "PAN ID"(please refer to page 76).

ZIGBEE Networking Instructions

- 2 Double click "28531" in "ID" column, a image appears as shown below. Select "Blending" → "Set Splicing Number" select "2 projectors on Position H and 1 projector on Position V" → "Set Local Position No" choose to "1" → Check "Welding line" to "on" → Set "Width of H-integration" to 300 (the default value of horizontal integration band width is 300, and the default value of vertical integration band width is 200. For this is horizontal blending, without using vertical integration band, it needs not to set the vertical integration band width) → adjust "Gamma" value → Click "Save and refresh PW data" as shown below.

Set current projector SubDevice ID: 28531 SubDevice ParentID: 0 Remark

Standard | LenzShift | KeyStone | Blending |

Set Splicing Number
Total number of H:
Total number of V:

Set Local Position
H-Position: V-Position:

NO	1	2

Set Parameter
Width of H-integration(0~400pixel):
Width of V-integration(0~300pixel):
Gamma(0~7):

Welding line [Advanced Gamma Set](#)

R 1023
G 1023
B 1023

Reset Save and refresh basic fusion data Save and refresh PW data

- 3 Set the other projector in the same way as described in step 2. Double click "42852" in "ID" column, a image appears as shown below. Select "Blending" → "Set Splicing Number" select "2 projectors on Position H and 1 projector on Position V" → "Set Local Position No" choose to "2" → Check "Welding line" to "on" → Set "Width of H-integration" to 300 (the default value of horizontal integration band width is 300, and the default value of vertical integration band width is 200. For this is horizontal blending, without using vertical integration band, it needs not to set the vertical integration band width) → adjust "Gamma" value → Click "Save and refresh PW data" as shown below.

Set current projector SubDevice ID: 42852 SubDevice ParentID: 0 Remark

Standard | LenzShift | KeyStone | Blending |

Set Splicing Number
Total number of H:
Total number of V:

Set Local Position
H-Position: V-Position:

NO	1	2

Set Parameter
Width of H-integration(0~400pixel):
Width of V-integration(0~300pixel):
Gamma(0~7):

Welding line [Advanced Gamma Set](#)

R 1023
G 1023
B 1023

Reset Save and refresh basic fusion data Save and refresh PW data

4. After the above operations completed, both projectors display an integration band frame, as shown below:

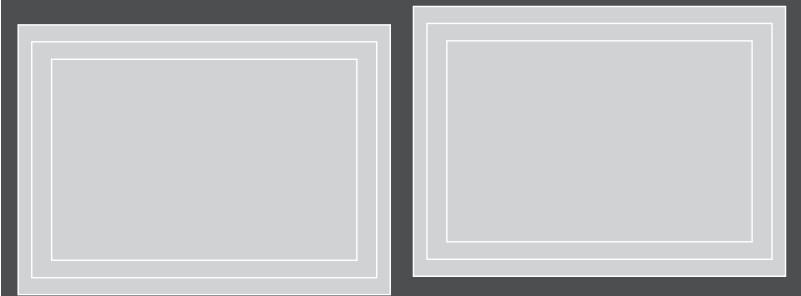

5. Regard the center of the projection screen as standard. Adjust the central integration line between these two projectors to the center line of such projection screen, as shown below:

Red line refers to center of the projection screen

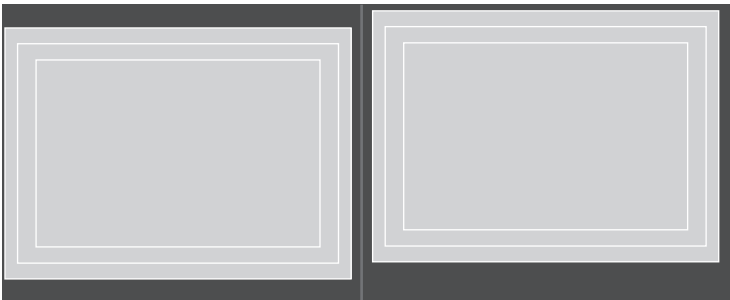

Center fusion line

Center line of the projection screen

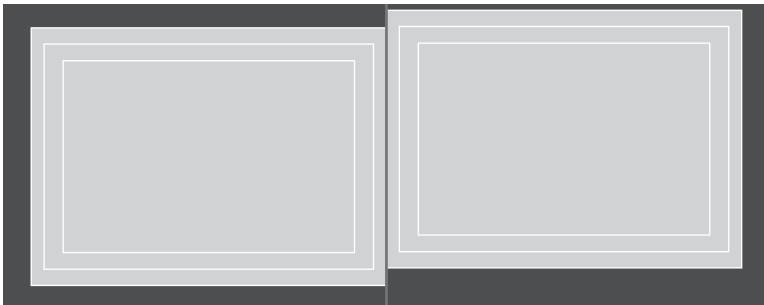

ZIGBEE Networking Instructions

- Adjust the lens up/down/left/right, focus and zoom under "LenzShift", as well as KeyStone and corner under "KeyStone" of the two projectors to achieve a integration band registration of two projectors, as shown below:

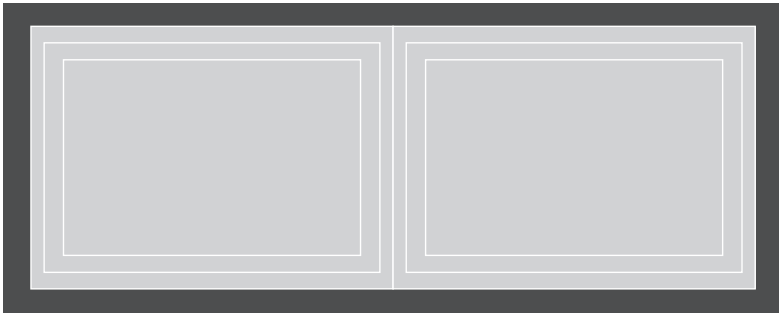

- Click "Welding line" to "off" → "Save and refresh basic fusion data" as shown below.

Set current projector SubDevice ID: 28351 SubDevice ParentID: 0 Remark

Standard | LenzShift | KeyStone | Blending |

Set Splicing Number
Total number of H:
Total number of V:

Set Parameter
Width of H-integration(0~400pixel):
Width of V-integration(0~300pixel):
Gamma(0~7):
 Welding line Advanced Gamma Set
R 1023
G 1023
B 1023

Set Local Position
H-Position: V-Position:

NO	1	2
1		

Reset Save and refresh basic fusion data Save and refresh PW data

Set current projector SubDevice ID: 42852 SubDevice ParentID: 0 Remark

Standard | LenzShift | KeyStone | Blending |

Set Splicing Number
Total number of H:
Total number of V:

Set Parameter
Width of H-integration(0~400pixel):
Width of V-integration(0~300pixel):
Gamma(0~7):
 Welding line Advanced Gamma Set
R 1023
G 1023
B 1023

Set Local Position
H-Position: V-Position:

NO	1	2
2		

Reset Save and refresh basic fusion data Save and refresh PW data

8. Input signal and you may see the effect after blending by two projectors, as shown below:



Note: After successful networking, there is no need to reset while use the projector after power is cut off. You only need to open file "projectorWLAN.exe".

How to disconnect ZIGBEE.

Click → "Reset" → "Save and refresh basic fusion data" → "Save and refresh PW data".

Set current projector SubDevice ID: 28351 SubDevice ParentID: 0 Remark

Standard | LensShift | KeyStone | Blending |

Set Splicing Number

Total number of H:

Total number of V:

Set Parameter

Width of H-integration(0~400pixel):

Width of V-integration(0~300pixel):

Gamma(0~7):

Welding line Advanced Gamma Set

R 1023

G 1023

B 1023

Set Local Position

H-Position: V-Position:

NO	1	2
1		

Reset Save and refresh basic fusion data Save and refresh PW data

✓Note:

- Remove the Rubber Cap on ZIGBEE antenna while you use, when you are not using, please install it.

EIKI

U.S.A.

EIKI International, Inc.
30251 Esperanza
Rancho Santa Margarita
CA 92688-2132
U.S.A.
Tel: 800-242-3454 (949)-457-0200
Fax: 800-457-3454 (949)-457-7878
E-Mail: usa@eiki.com

Deutschland & Österreich

EIKI Deutschland GmbH
Am Frauwald 12
65510 Idstein
Deutschland
Tel: +49-6126-9371-0
Fax: +49-6126-9371-14
E-Mail: info@eiki.de

China

EIKI (Shanghai) Co., Ltd.
LAKESIDE OASIS MIDDLE RING
BUSINESS CENTRE
Block 1, Room 606,
1628, Jin Sha Jiang Road
Shanghai, 200333
CHINA
Tel: 86-21-3251-3993
Service Hot line: 86-21-3251-3995
Fax: 86-21-3251-3997
E-mail: info@eiki-china.com

Australia

EIKI AUSTRALIA PTY LTD
Level 5, 11 Queens Road, Melbourne,
Victoria 3004
Tel: +61 (03) 8530 7048
Fax: +61(03) 9820 5834
E-Mail: sales@eiki.net.au

Canada

EIKI CANADA - Eiki International, Inc.
P.O. Box 156, 310 First St. - Unit 2,
Midland, ON, L4R 4K8, Canada
Tel: 800-563-3454 (705)-527-4084
Fax: 800-567-4069 (705)-527-4087
E-Mail: canada@eiki.com

Eastern Europe

EIKI CZECH SPOL. s.r.o.
Nad Cementárnou 1163/4a
Praha 4, Podolí
147 00
Czech Republic
Tel: +420 241 410 928
+420 241 403 095
Fax: +420 241 409 435
E-Mail: info@eiki.cz

South East Asia

EIKI Industrial (M) Sdn Bhd
No. 11, Nouvelle Industrial Park,
Lorong Teknologi B, Taman Sains Selangor
1, Kota Damansara PJU5,
47810 Petaling Jaya, Selangor Darul Ehsan,
Malaysia
Tel: +603-6157-9330
Fax: +603-6157-1320
E-Mail: sales@eiki.my

Japan & Worldwide

EIKI Industrial Company Limited.
6-23 Teramoto, Itami-shi, Hyogo,
664-0026 JAPAN
Tel: +81-72-782-9492
Fax: +81-72-781-5435

WorldWide Website <http://www.eiki.com>