

PjNET-50 OWNER'S MANUAL

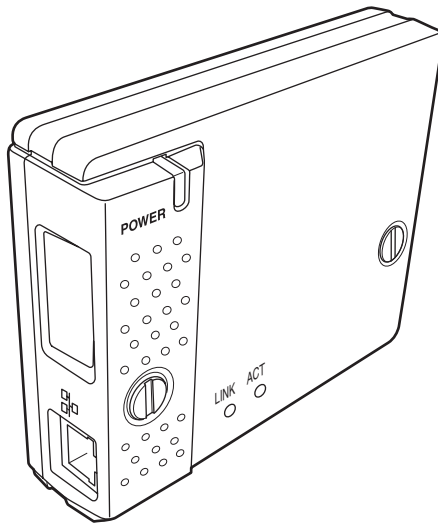

Pj-to NetDirector

Network Capture 3

Network Viewer 3

Network Communication

XG250/XG300/XG400,SXG400 Series

Compliance

Federal Communication Commission Notice

This equipment has been tested and found to comply with the limits for a Class B digital device, pursuant to part 15 of the FCC Rules. These limits are designed to provide reasonable protection against harmful interference in a residential installation. This equipment generates, uses and can radiate radio frequency energy and, if not installed and used in accordance with the instructions, may cause harmful interference to radio communications. However, there is no guarantee that interference will not occur in a particular installation. If this equipment causes harmful interference to radio or television reception which can be determined by turning the equipment off and on, the user is encouraged to try to correct the interference by one or more of the following measures:

- Reorient or relocate the receiving antenna.
- Increase the separation between the equipment and receiver.
- Connect the equipment into an outlet on a circuit different from that to which the receiver is connected.
- Consult the dealer or an experienced radio/TV technician for help.

Use of shielded cable is required to comply with class B limits in Subpart B of Part 15 of FCC Rules.

Do not make any changes or modifications to the equipment unless otherwise specified in the instructions. If such changes or modifications should be made, you could be required to stop operation of the equipment.

Model Numbers	: PjNET-50
Trade Name	: EIKI
Responsible party	: EIKI International, Inc.
Address	: 30251 Esperanza Rancho Santa Margarita CA 92688-2132
Telephone No.	: 800-242-3454 (949-457-0200)



CAUTION ON USE IN NETWORK

- When you receive an alert e-mail from the projector, you must check the projector immediately. Fire or accident may result if the projector is used in an abnormal condition.
- When you install the projector at remote location and use it through the network, you must perform the safety inspections periodically. In this case you must pay attention to the change of environment in which you installed the projector. It may cause fire or an accident depending on the change of environment.

CAUTION

Eiki International, Inc. assumes no responsibility for the loss or damage of data or damage of the computer caused by using this product.



The CE Mark is a Directive conformity mark of the European Community (EC).

NOTES ON Lithium Battery (CALIFORNIA USA ONLY)

This product uses a Lithium Battery which contains Perchlorate Material - special handling may apply. See www.dtsc.ca.gov/hazardouswaste/perchlorate

Notas acerca de pilas de litio (SOLO PARA CALIFORNIA, EE.UU.)

Este producto usa una pila de litio que contiene el material perclorato – puede ser necesario una manipulación especial.

Consulte la página www.dtsc.ca.gov/hazardouswaste/perchlorate

Contents

Compliance	2
Federal Communication Commission Notice.....	2
Chapter 1 Preparation	7
Features.....	8
Operating environment of Pj-to NetDirector	11
Before use.....	12
Chapter 2 Installation.....	15
Flow of installation.....	16
[1] Name and function of each part.....	17
[2] Installation and network configuration.....	18
Mounting	18
Connection of LAN cable	19
Network configuration.....	20
Network PIN code setting	22
How to enter the numbers with the remote control 10-key buttons	23
Notice about system construction.....	24
[3] Installing the software.....	25
Network Viewer & Capture 3 Installation	25
File Converter 2 Installation.....	27
Chapter 3 Basic Setting and Operation.....	29
Login the setting page of the projector	30
1 Enter the IP address.....	30
2 Select a display mode and login.....	30
3 Display of main setting page.....	31
How to use the setting page	32
Initial setting.....	34
Network PIN code setting	35
PJLink and password setting.....	35
Date and time setting	36
Network configuration.....	37
E-mail setting	38
Examples: Type and contents of alert mail	40
SNMP setting.....	42
Chapter 4 Controlling the Projector	45
Power control and status check.....	46
Controls.....	48
Input.....	48
System.....	49
Image adjustment.....	50
Sound	51
Menu	51
PC adjustment.....	52
Setting up the projector	53
Save the controls and settings.....	55
Store/free the settings.....	55
Check the saved items.....	56
Load a control set	56
Timer setting	57
How to set the timer.....	57
Check the timer events.....	58
Change the event mode.....	58
Projector information.....	60
Multi-control.....	62
Controlling and setting the multi-projectors.....	62

Start/stop the multi control.....	63
Register the projector.....	64
Confirmation of registered projector.....	64
Change the mode of the registered projector.....	65
Status.....	65
Conf. & Change page in the light mode.....	66
Controlling all together.....	66
Setting all together.....	66
Viewer auto setting all together.....	67
Chapter 5 Network Capture.....	69
About Network Capture function.....	70
Launching the Network Capture 3.....	70
Commands on the task bar.....	70
Parameter set up.....	71
Using the Real Time Capture.....	72
Registering the computers.....	72
[1] Control by the computer.....	73
[2] Control by the web browser.....	74
[3] Control by the projector.....	75
Advanced using example.....	76
Using the Network Communication.....	77
Settings before using the Network Communication.....	78
Description of capture editing window.....	79
How to use the Network Communication.....	81
Start the communication.....	81
Join the communication (only for Sub PC).....	81
Exit from the communication (only for Sub PC).....	81
End the communication.....	81
Acquire and release of editing authority.....	81
Edit capture image.....	82
Network Communication operation and change of state.....	84
Executing the forcing mode.....	85
Error information.....	86
Chapter 6 Network Viewer.....	87
Creating the available data [Network Viewer 3].....	88
[1] How to use the Network Viewer 3 (File Converter 1).....	88
[2] How to use the Network Viewer 3 (File Converter 2).....	92
Creating a program file [Program Editor].....	93
Procedure of making program.....	93
Setting up the display order and time of the images.....	95
Using the Network Viewer function.....	98
[1] Control by the web browser.....	98
[2] Control by the projector.....	102
Chapter 7 Appendix.....	105
Examples of connection.....	106
Web browser setting.....	108
Examples: OS/Browsers.....	109
Product specification.....	113
Port specification.....	114
Q&A.....	115



Chapter 1

Preparation

Describes features and operating environment of this product.

1

Features

Real Time Capture function (☞ p.72)

To display the screen image of the computer by the projector through the network in real time.

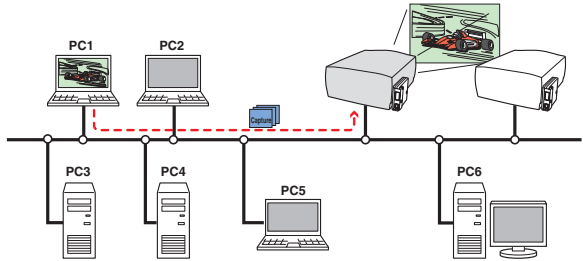

Network Communication function (☞ p.77)

To communicate by sharing the captured image of a computer with multiple computers and a projector. User can draw the text and figure on the captured image by using a drawing tool.

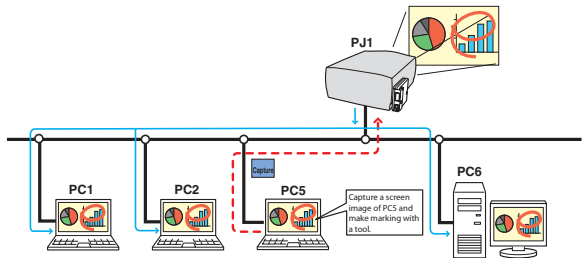

Network Viewer function (☞ p.87)

To acquire the JPEG image data from the file servers placed in the network and project them by the projector.

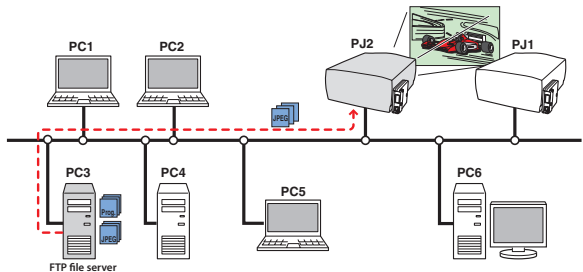

Web Management function (p.45)

With this function, you can monitor projector functions such as power status, lamp status, input mode, signal condition, lamp-use time, etc. through the network by using the web browser installed on your computer.

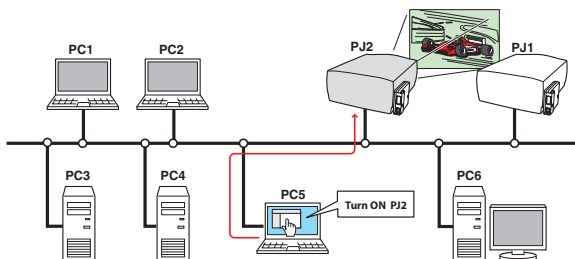

E-Mail Alert function (p.38)

The projector (Network Unit) sends messages to the registered e-mail addresses when a lamp abnormality or power failure occurs with the projector. This message describes how to solve the cause of the problems. You can take efficient action for quick recovery.

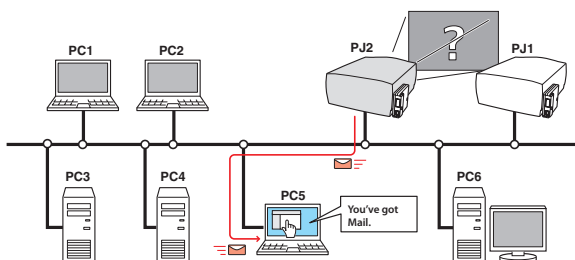

SNMP Agent function (p.42)

To send the information of the projector to the SNMP manager. Enables you to manage the projector condition with the supplied SNMP manager software.

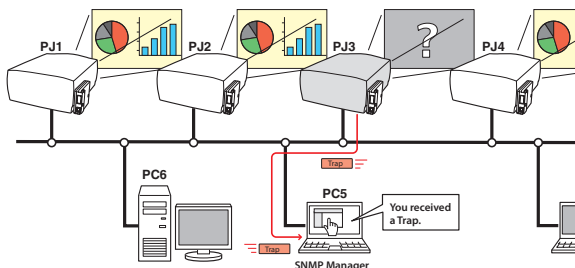

Multi-control function (p.62)

A single computer can control and set up the multiple projectors at the same time.

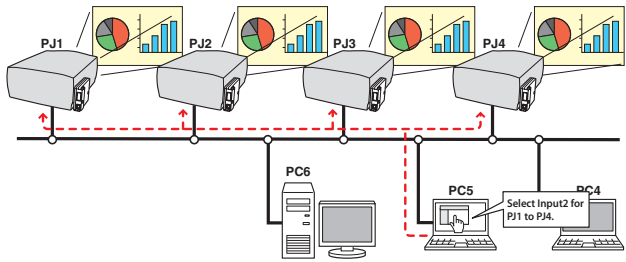

Automatic On/Off using Clock function (p.57)

Automatically turn on or off the projectors at specified date/day and time by using the clock function.

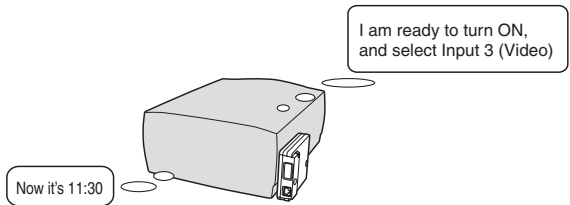

SNMP Manager function

A function to manage the condition of projectors in the network by using the SNMP protocol. The managing computer needs to provide an SNMP managing software. Refer to the owner's manual of the "PJ Network Manager" supplied separately for further details.

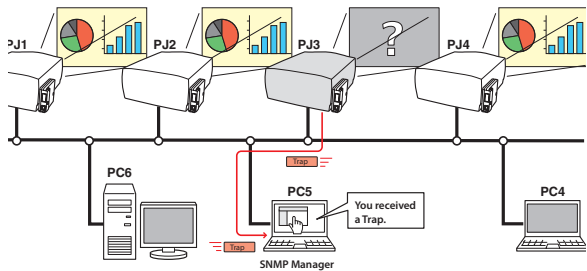

Operating environment of Pj-to NetDirector

To perform the managing and setting of the projector by using this product, the environment described below is required.

		Standard mode
Operating System		Windows 98, Windows Me, Windows NT4.0SP6 Windows 2000, Windows XP, Windows Vista (32bit version)
Computer environment	Recommended CPU	Higher than Pentium III 900MHz
	Memory	64MB (Minimum)/ 128MB or more(Recommended) 128MB or more for Windows XP 1GB or more for Windows Vista
	HDD free area	100MB or more
	Drive equipment	CD-ROM drive
	Display setting of computer	Support one of following resolutions; VGA (640 x 480), SVGA(800 x 600), XGA(1,024 x 768) Number of colors: Either of 16 bit (65,536 color 24/32 bit (16,77 million colors))
	Network card	The computer must provide a 10Base-T or 100Base-TX network card.
Web Browser*		Internet Explorer version 5.0, 5.5 or 6.0 Netscape Navigator version 6.2, 7.0 or 7.1 * Used to control and set up the projector. The layout of pages in the browser may slightly differ from each type of application or operating system you use.
Plug-Ins		Adobe Flash Player version 6.0,79,0(6.0r79) or later
Internet Mailer*		- Microsoft Outlook - Microsoft Outlook Express - Netscape Mail * Required the internet e-mail application software to receive an e-mail alert sent from this product. If you do not use the function E-mail Alert, this application is not required.
FTP Service *		- FTP server (Windows 2000 Professional or Windows XP Professional) * The FTP service provided with the Windows 2000 Professional or Windows XP Professional is required when using the Network Viewer function.

PDA restriction

The PDA can be used for the Light mode*1 only. The operating system of the PDA is PocketPC2002 or higher. The version of the Adobe Flash Player is 6.0,81,0 or higher.

*1 The "Light Mode" and "Standard Mode" will be explained on item "Display Mode" (p.30-32)

The limitation*1 of connection between this product and hub or computer

Suitable LAN cables are limited by length and type as follows;

Connection	Type of usable LAN cable	Maximum length
Network Unit - Hub	UTP Straight Cable with category 3 or 5 *2	100m
Network Unit - Computer	UTP Cross Cable with category 3 or 5*2	100m

*1 There may be other limitations depending on your network environment or LAN specification. Please consult your network administrator for further details.

*2 Category of LAN cable indicates the cable quality. Normally, a cable with category 3 or 5 is used for 10Base-T network, and a cable with category 5 is used for 100Base-TX network.

Before use

Package contains

The package contains following items. Check each item as you unpack the package. If you have any of the following items missing, contact the sales dealer.



Network unit 1 piece



Quick Setup Guide 1 piece
English/Japanese



Software CD-ROM 1 piece
Network Viewer & Capture 3 software
PJ Network Manager software



Document CD-ROM 1 piece
Pj-to NetDirector Owner's Manual
PJ Network Manager Owner's manual

Notice

Expression/Abbreviation

The word "projector" found in this manual means "projector provided with Network unit" unless otherwise noted.

The OS of the computer and the Web browser described in this manual is Windows XP Professional and Internet Explorer 6.0. In case of another OS or Web browser, some instruction procedures may differ from the actual operation depending on your computer environment.

Use of this manual

This manual does not provide the description of basic operation and functions for computer, web browser, projector and network. For instructions about each piece of equipment or application software, please refer to the respective booklet.

Trademarks

Ethernet is a registered trademark of Xerox Corporation. Microsoft, Windows, Windows NT, Windows XP and Windows Vista are registered trademarks of Microsoft Corporation. Internet Explorer is a registered trademark of Microsoft Corporation. Netscape Navigator and Netscape Communicator are trademarks or registered trademarks of Netscape Communications Corporation. JavaScript is a registered trademark of Sun Microsystems, Inc. PjLink is a registered trademark of JBMIA (Japan Business Machine and Information System Industries Association).

Other product or brand names in this manual are registered trademarks or trademarks of their respective owners.

* Unauthorized use of a part or whole of the contents in this manual is prohibited.

* The contents of this manual are subject to change without notice.

2

Chapter 2 *Installation*

Describes how to install the network unit and software, and configure the network.

Flow of installation

The following are instructions for attaching this product to the projector and connecting it to the network. Please review the entire procedure to become familiar with it.

1 Function of the network unit (☞ p.17)

Explains the name and functions of each part of the network unit.

2 Installation and network configuration (☞ p.18-24)

- 1** Mount this product onto the projector.
- 2** Connect the LAN cable and join it to the network.
- 3** Configure the network of the network unit.
- 4** Set the Network PIN code.

3 Installation of the software (☞ p.25-27)

Explains how to install the software Network Viewer & Capture 3 into your computer.

Set up is complete

The preparation is completed to control the projector connected to the network. At next step, set up and control the projector via the network by using the web browser installed on your computer. Please see chapter 3 "Basic setting and operation". (☞ p.29)

[1] Name and function of each part

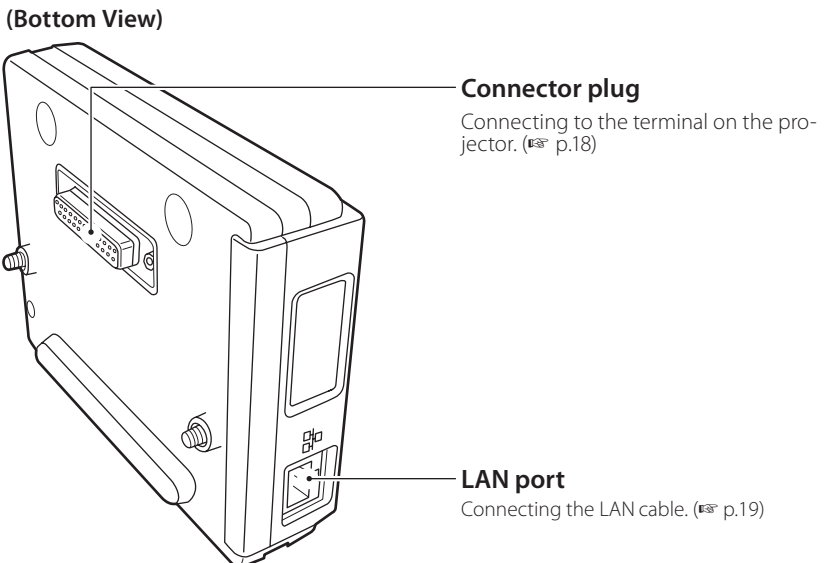
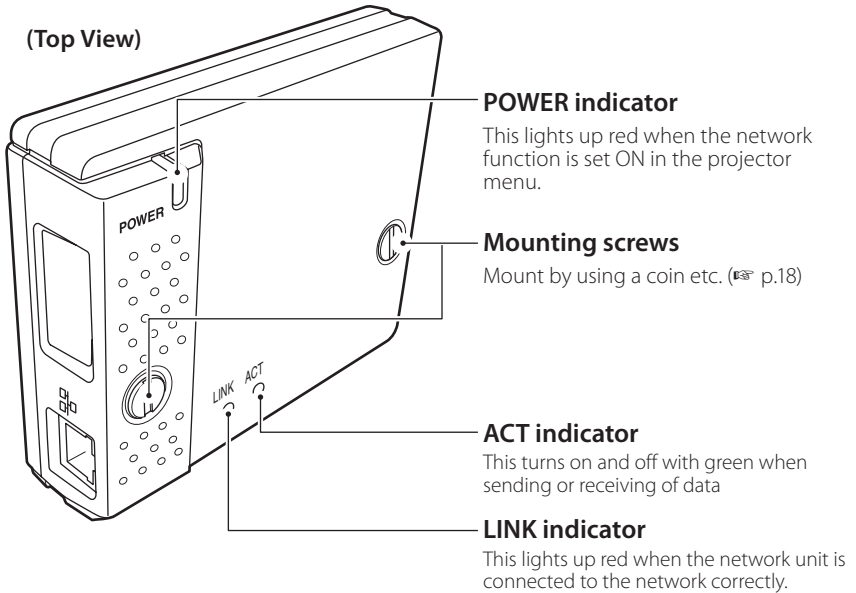

[2] Installation and network configuration

Mounting

1 Disconnect the AC plug from the projector.

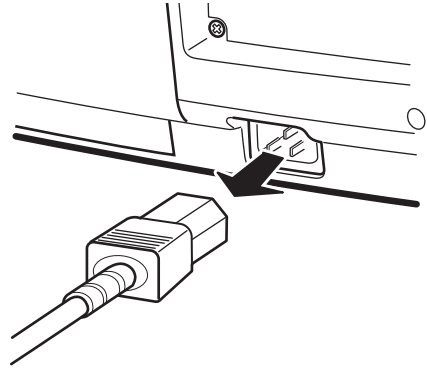

2 Remove the connector cover and screw covers (2 pieces) from the projector and insert plug on this product to the option connector.

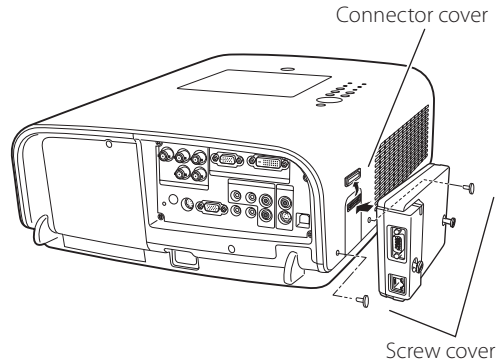

3 Tighten two screws by using a coin etc.

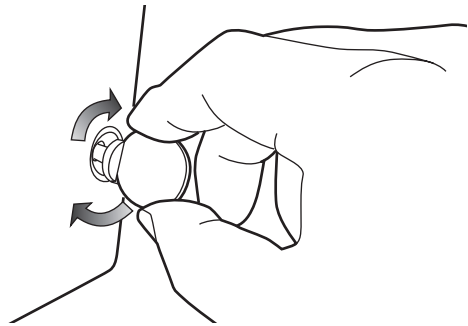

Caution

- ⚠ AC cord must be disconnected when mounting or removing this product otherwise it may damage the product.
- ⚠ Do not install multiple network units into a projector otherwise it may damage the product.
- ⚠ Connect the AC cord after connecting the LAN cable and computer.

Connection of LAN cable

To connect to the network, it is required to use the UTP (Unshielded Twisted Pair) straight cable with RJ-45 plug. There are two different types of cables depending on whether the network is constructed with 10Base-T or 100Base-TX. Prepare the Hub (10Base-T or 100Base-TX) to distribute the network cable if required.

1 Disconnect the AC plug from the projector.

2 Connect the UTP straight cable to the LAN port on the network unit.

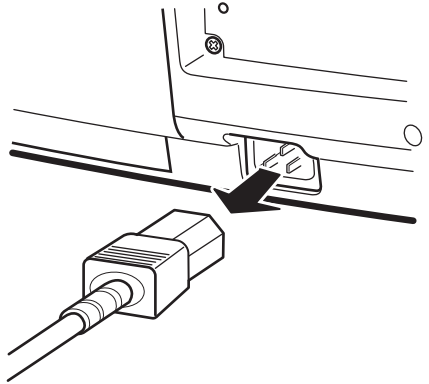

3 Connect the UTP straight cable to the hub.

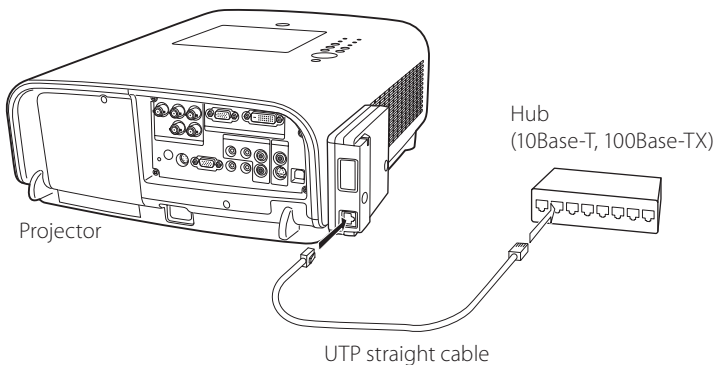

- ☞ Use the UTP cross cable when you connect the computer and projector directly not using the hub.
- ☞ When you connect the projector into the 10Base-T network, use cable with category 3 or 5. When you connect the projector into the 100Base-TX network, use cable with category 5.
- ☞ The length of cable between hub and projector should be less than 100m.

Network configuration

Confirmation of the network menu

When installing this product to the projector, the network on-screen menu items for this product are activated automatically. If not activated, the product may not have been installed correctly. Please check item "Mounting" (p.18).

Configure the network

Before performing the network configuration, prepare network address numbers (IP Address, Subnet Mask, Default Gateway, DNS) assigned to the projector. Ask your network administrator for the network address.

For example, the case where the following network address is set up is explained.

IP Address	: 192.168.1.201
Subnet Mask	: 255.255.255.0
Default Gateway	: 192.168.1.1
DNS	: 0.0.0.0

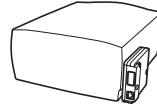

The default network configuration is set as follows.

IP Address	: 192.168.0.2
Subnet Mask	: 255.255.255.0
Default Gateway	: 0.0.0.0
DNS	: 0.0.0.0



1 Selection of network menu

Turn on the projector and display the menu on the screen. Select network icon from the main menu and then press **SELECT** button once. Check that the mode is "On". If not, change mode to "On" using the point buttons (◀▶).

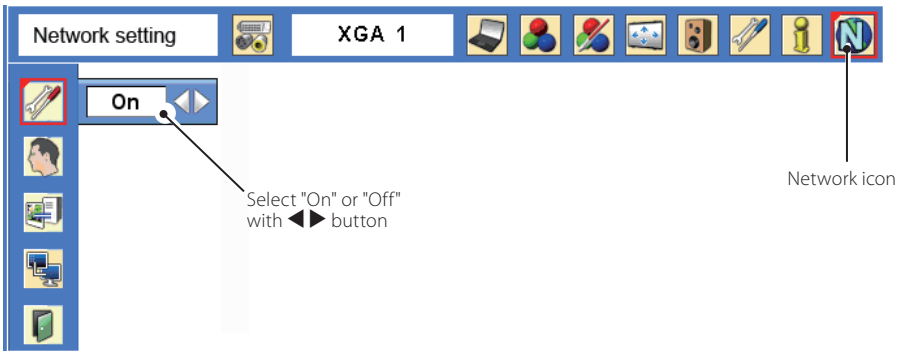

- ☞ The network unit begins restarting each time the mode is set "On".
- ☞ Change the mode to "On" then the "Please wait..." message will appear and after completing the operation, the message will disappear.

2 Configuration for IP Address/ Sub net/ Gateway*1/DNS*2

Press **SELECT** button again. The following network setting pallet appears on the screen. Enter the specified network addresses.

Network setting				
IP address	192	168	1	201
Subnet	255	255	255	0
Gateway	192	168	1	1
DNS	0	0	0	0
		Set		Cancel

The red frame moves sequentially left or right with ◀▶ button. The number up or down with ▼▲ button.

How to enter the numbers

There are 2 ways to enter the numbers, one is by using the point buttons (▼▲) on the remote control or on the projector, the other is by using the 10-key buttons on the remote control. For further information see "How to enter the numbers with the remote control 10-key buttons" (p.23).

3 Fixing the network configuration

After completing the entering of address, select "Set" and press **SELECT** button. The network unit starts re-booting and displays message "Please wait..." on the screen until the re-booting is complete. Do not disconnect the AC cord during this period. After that the network setting pallet will disappear on the screen.

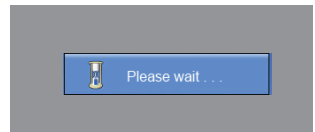

Completing of installation

Now the installation is complete. The IP address of this projector is set to "192.168.1.201".

Item	Description
IP address	Sets IP address of the projector
Sub net.....	Sets Subnet mask. Normally sets 255.255.255.0
Gateway*1	Sets IP address of the default gateway (Router)
DNS*2	Sets IP address of the DNS server. Must be set when using the e-mail function

☞ Refer to the projector's owner's manual for operation of the projector.

*1 In the network environments not using a Gateway or Router, the Gateway address should be set to [0.0.0.0].

*2 If you do not use the functions E-mail or DNS server, it is also set [0.0.0.0] for the DNS address.

Network PIN code setting

The Network PIN code can be set to restrict access to the setting page of the projector using the web browser.

 **Default Network PIN code [0000] means no Network PIN code is set.**

1 Displaying Network PIN code menu

Select network menu and then select "Network PIN code" sub menu. Press **SELECT** button twice to display the Network PIN code entry pallet.

* The number on the pallet is the current Network PIN code.

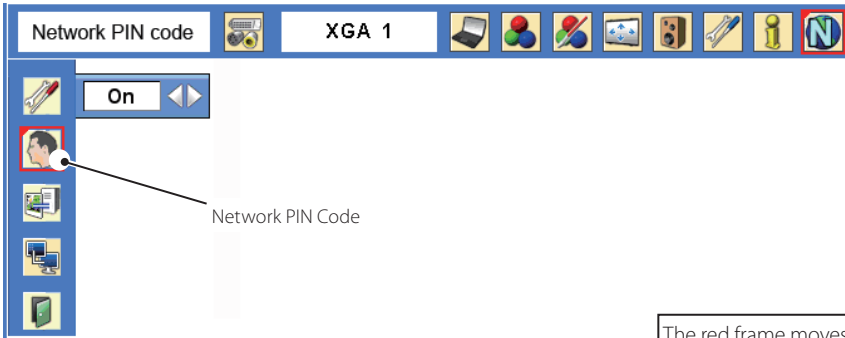

The red frame moves sequentially left or right with ◀▶ button. The number up or down with ▼▲ button.

2 Entering the Network PIN code

To enter the Network PIN code, use point buttons (◀▶ ▼▲) on the projector or the remote control.

3 Fixing the Network PIN code

After entering a 4-digit number, select "Set" by using point buttons (◀▶) and then press **SELECT** button.

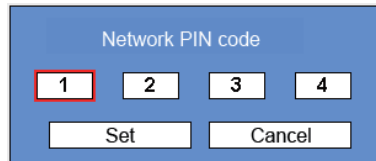

 The remote control 10-key buttons can be used for entering the Network PIN code. See item "How to enter the numbers with the remote control 10-key buttons" (p. 23)

 It is recommended to set up the Network PIN code when you connect the projector to the network. This setting is carried out through the projector's menu and also it can be set through the network using the web browser. For further information, refer to item "Initial Setting/Network PIN code setting" (p. 35).

 Valid characters for the Network PIN code are only numbers 0 to 9. The number "0000" means no Network PIN code is set.

 This Network PIN code is not to restrict the use of the projector. This Network PIN code is to set the security against the use of the projector through the network.

How to enter the numbers with the remote control 10-key buttons

During the network address input mode or the network PIN code input mode, some of the buttons on the remote control are operate as the 10-key input buttons.

- 1 Select a column with a red frame by using the point buttons ◀ or ▶.
- 2 Press 0 to 9 key assigned to the buttons to enter the numbers.
*To change the number in a column, enter the number again.
- 3 After entering the number in the column, press the point buttons ◀ or ▶ to move the red frame.
- 4 Repeat steps 1 to 3 for entering all the network address.

Network setting				
IP address	192	168	1	201
Subnet	255	255	255	0
Gateway	192	168	1	1
DNS	0	0	0	0
	Set		Cancel	

During the numbers input mode, these buttons operate as the 10 key buttons



Notice about system construction

For installation of multiple projectors into the same network with network unit.

Do not install multiple projectors with network units that have their default network settings to the same network. The use of the network units which have the default IP address set to the same network settings will cause IP addresses to collide and create a malfunction. When you install multiple projectors into the same network, configure the network with the following steps.

1. Change the IP address from the default IP address. To change the IP address, use the network setting menu on the projector. Please see item "Network configuration" for further information (☞ p.20).
2. Make sure that there is no network equipment set with the same IP address in the network before connecting to the network.
3. When installing other projectors, follow the above steps to change the IP address and connect to the network.

In case of installing the projector with network unit into the network constructed with the DHCP/BOOTP server.

This network unit does not support the DHCP/BOOTP server. The static IP address must be manually configured. To use this product in this network environment, set it up so that the DHCP/BOOTP server does not assign the IP address configured to this product for another device on the network. Please consult your network administrator for further information.

[3] Installing the software

It is required to install the software into your computer to use the Network Capture function and Network Viewer function. Please install the software as follows.

Note: To install the software into the computer with Windows 2000, Windows XP, Windows NT or Windows Vista, you should logon as administrator. Before installation, make sure that the other applications are closed, otherwise proper installation cannot be made.

Network Viewer & Capture 3 installation

- 1 Set the supplied Network Viewer & Capture 3 CD-ROM into the CD-ROM drive of your computer. Double click **SetupTool.exe** icon in the "Tool" folder in the CD-ROM.
- 2 Select "English [United States]" from the pull-down menu on the "Choose Setup Language" window and click **OK** button to start installing and then follow the installation wizards.

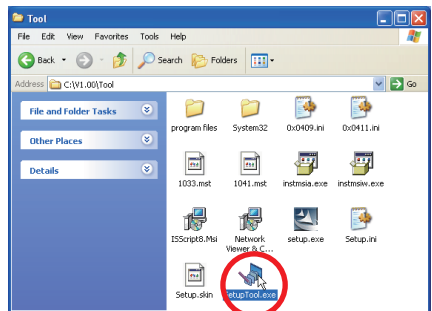
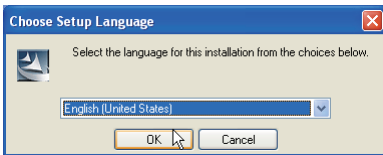
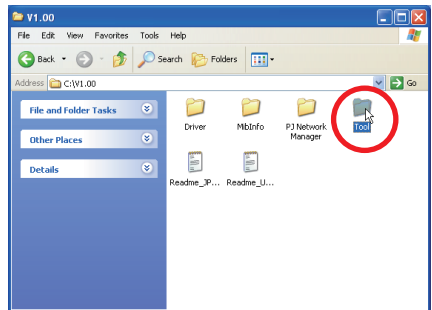

As the "License Agreement" will appear, read contents carefully and click **Yes** button if you agree to the license agreement to proceed with installing.

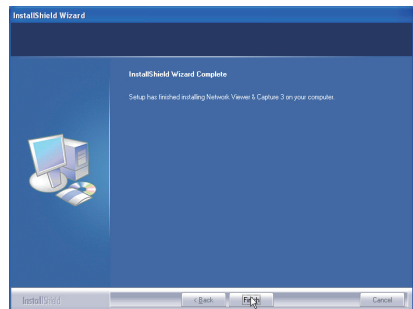
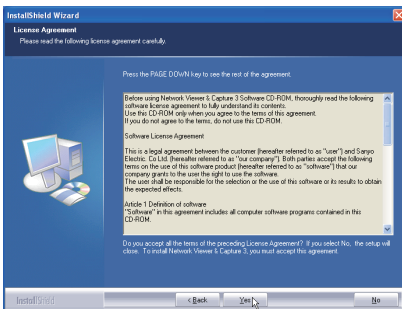

Installed software

The following 3 software are installed on your computer.

● **Network Capture 3:**

Capture the displayed image of the computer and serve it to the projector via the network.

This software is registered into "startup folder" of the computer and the capture icon stays on the task bar after booting the computer.



● **Network Viewer 3 (File Converter 1):**

Converts to the JPEG*1 data format which can be projected with the projector from the JPEG, bitmap and Power Point files.

● **Network Viewer 3 (Program Editor) :**

This is a tool to make the program which has a function to specify and order the projecting JPEG image data stored in the file servers.

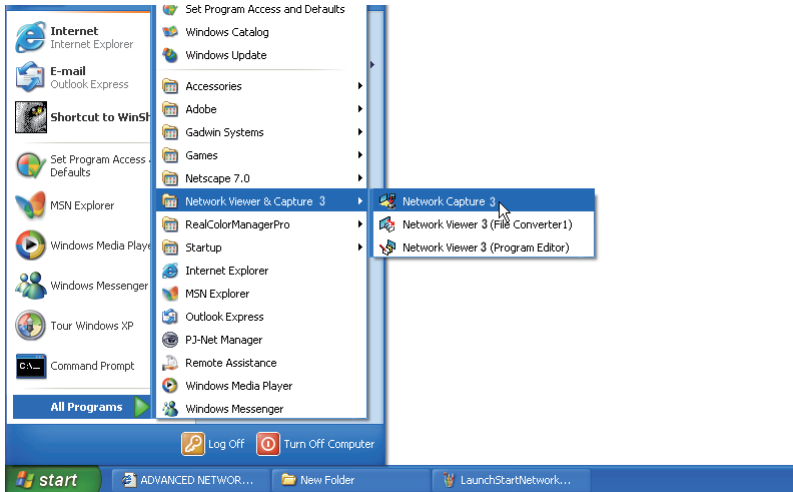

* When you install the Network Capture 3 software on Windows Vista, the warning dialog "User account control" will appear. In that case, click **Allow** button to proceed with installing.

* To uninstall these software, use "Add/Remove Program" from the control panel. (In case of Windows Vista, use "Programs and Features" from the control panel.)

*1 This product supports the JPEG image format. This file is needed to convert to the optimized JPEG file by using the File Converter 1 software previously. Refer to the item "Creating the available data [Network Viewer 3]" (p.88) about data converting for the projection.

File Converter 2 Installation

- 1 Set the supplied Network Viewer & Capture 3 CD-ROM into the CD-ROM drive of your computer. Double click **SetupDrv.exe** icon in the "Driver" folder in the CD-ROM.
- 2 Select "English [United States]" from the pull-down menu on the language selection window and then click **Install** button to start installing.

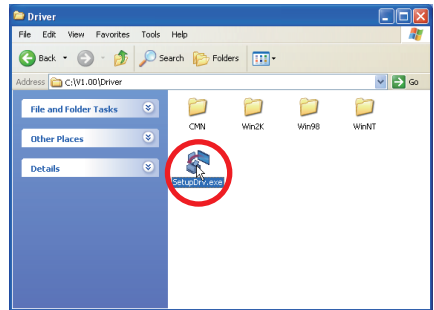
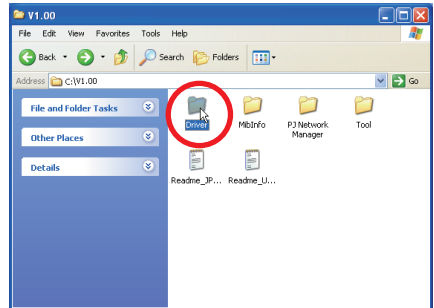
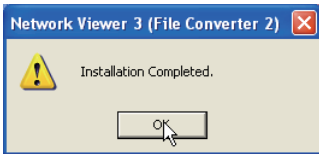
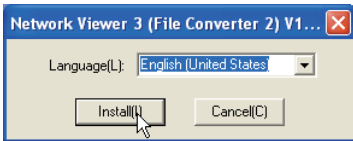

Installed software and places

Network Viewer 3 (File Converter 2) is installed in the "Printers and Faxes" folder in the "Control Panel".

● Network Viewer 3 (File Converter 2):

This is a kind of the printer driver to convert to the JPEG data optimized to project by the projector from any of the documents created by the application software.

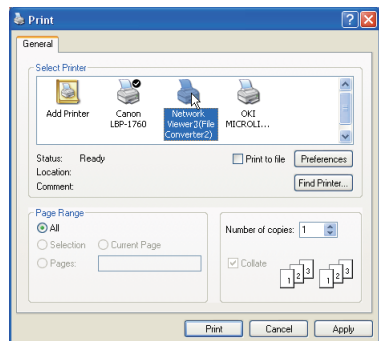

* To uninstall Network Viewer 3 (File Converter 2), just delete the "Network Viewer 3 (File Converter 2)" icon from the "Printers and faxes" folder.

3

Chapter 3 ***Basic Setting and Operation***

Describes basic operations and settings for controlling the projector by using the web browser. It is required that computer and projector is connected to the network and the network address is properly configured.

Login the setting page of the projector

1 Enter the IP address

Launch the web browser installed in your computer, enter the IP address into the "Address" on the browser and then press "Enter" key.

Enter the address (192.168.1.201) that you configured in item "Network configuration" (p.20). The default IP address is [192.168.0.2].

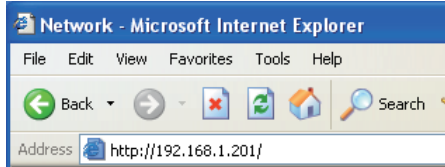

2 Select a display mode and login

This product provides 2 types of control mode, Standard Mode and Light Mode as the below. Select a proper mode to match your PC and network environment by clicking on the text link. Once you select your desired display mode, the setting page you selected display mode will be displayed automatically from the next login. To change the display mode, click "Top" on lower-right corner of the setting page (p.31).

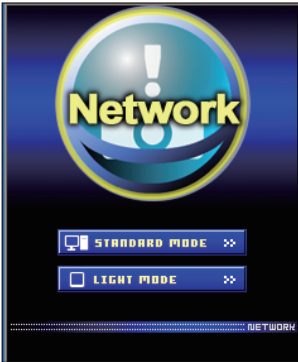

STANDARD MODE

For computer display, displays graphical menus and settings. This mode is recommended for standard use.

LIGHT MODE

Displays with 200 x 300 dots. This mode is optimized for use of the handheld computer, PDA, etc. It is also convenient if the network traffic is heavy. (This mode has some limitations on the network viewer and multi-control functions.)

If the setting page has set the password, the authentication window will appear. In this case type "user" onto the **User Name** text area and the login Network PIN code onto the **Password** text area and then click **OK** button.

* The entering User Name must be "user" and it can not be changed.

[Note]

When accessing the projector for the first time or the Network PIN code "0000" is set, the auto-login will be performed and the next main setting page is displayed.



3 Display of main setting page

The following main setting page will be displayed according to your display mode selection. Perform various kinds of settings through this page. Click on the menus to display the control and setting pages.

1 Main setting page in the Standard Mode display

The screenshot shows the projector's main setting page. The background is a blue grid with various icons for settings like Initial setting, Power & Status, PC Adj., Control, Setting, E-mail setting, Save, Network, MMS control, Timer, Information, and SNMP setting. The 'Control' menu is selected, showing a sub-menu with 'Input', 'System', 'Image adj.', and 'Menu'. The 'Image adj.' sub-menu is open, showing 'Contrast' (32), 'Brightness' (32), 'Color' (---), and 'Tint' (---). A clock display in the top right corner shows '2005/9/7 (Wed) 19:30:33 ON/DFF'. A 'TOP' button is in the bottom right corner.

Clock display
Display on or off by clicking text ON or OFF

Sub menu tab
Switches the sub menu tab.

Page numbers
Switches the pages by clicking the number's tab.

Main menu
For selection of control and setting items of the projector.

Setting page
Displays the control and setting items according to the selected menu.

Returns to Display Mode selection page (p.30)

This Standard mode display is mainly used through this manual for the setting and control description.

If your computer does not have the Adobe Flash Player version 6 or later, follow to the message on the control page to install the Adobe Flash Player. For further product information or installing, see the Adobe homepage.
<http://www.adobe.com>

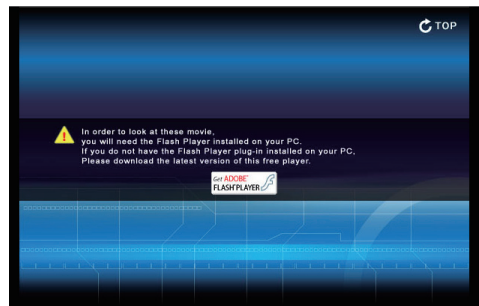

2 Main setting page in the Light Mode display

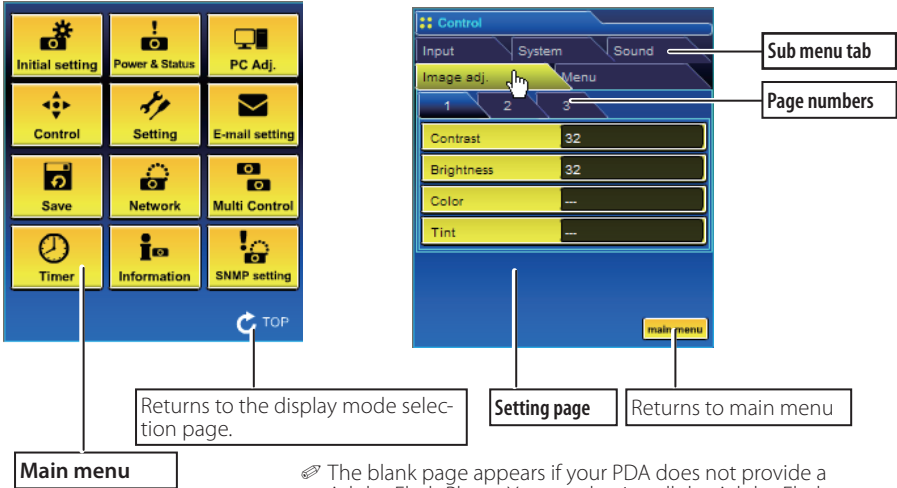

The blank page appears if your PDA does not provide a Adobe Flash Player. You need to install the Adobe Flash Player. (☞ p.31)

The network viewer function in the Light mode has following limitation;

- Cannot select the program or folder for the display (☞ p.97, p.99)
- Cannot check up the images in the folder or program (☞ p.100).

How to use the setting page

To control and set up the projector, use the setting menus on the web browser. Describes the basic operation and procedures commonly used on this manual.

Example of the Setting Page

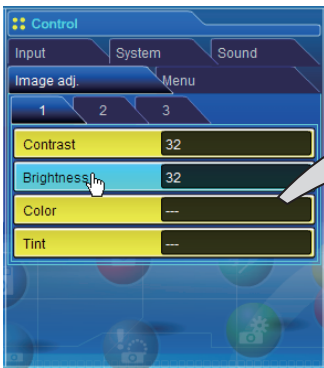

The setting pallet appears when clicking the item. Change the value by clicking ▲ or ▼ button, or type the number onto the text box directly and then click **Set** button.

* Each item has a valid setting range respectively.

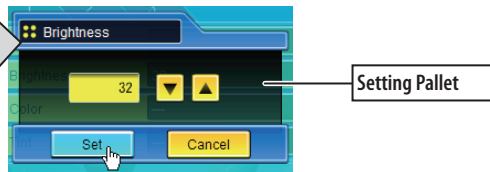

The value in the text box indicates current value.

Each item has a valid setting range. The setting value exceeding this becomes invalid. Some control items can not be used depending on the selecting input mode or functions of the projector you use. In this case, the values of those items are indicated with "---".

Type of the setting pallet

Text box setting

Enter a number or text and then click **Set** button.

or

Change a value with ▲ or ▼ button and then click **Set** button.

The value changes quickly when keeping pressing ▲ or ▼ button.

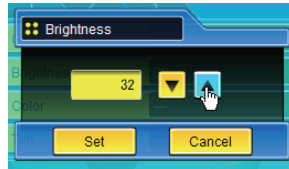
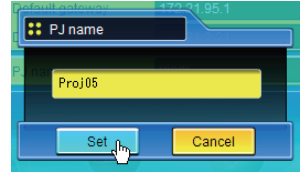

Pull-down menu setting

Select an item with pull-down menu button and then click **Set** button.

or

Select an item by clicking ▲ or ▼ button.

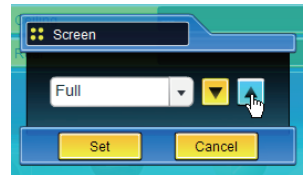
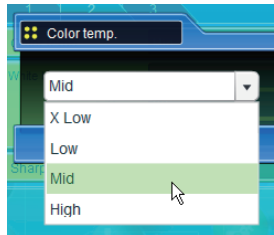

Radio button setting

Select an item by selecting a radio button

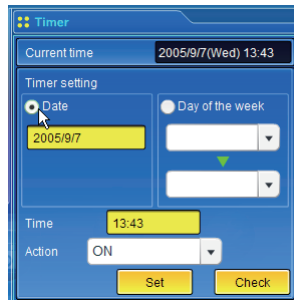

Check box setting

Select items by ticking on check boxes.

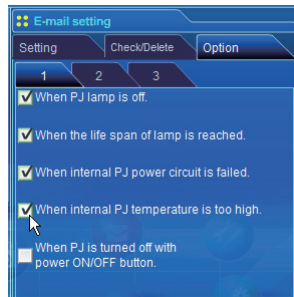



Initial setting

After installing this product to the projector, perform the following basic initial setting.

Click **Initial Setting** on the main menu to display the initial setting page.

The model name of the projector on which this product is mounted is displayed on the page.



Item	Description
Language.....	Switches display language on the setting page. English or Japanese.
Model name	Indicates the model name of the projector provided with the network unit
Network PIN code	Sets the Network PIN code to login the setting page (p.35)
PJLink.....	Switches PJLink password authentication on or off (p.35)
Password.....	Password for PJLink function
Temperature.....	Switches display temperature unit Centigrade or Fahrenheit

Caution

Use of Battery

This product provides a lithium battery. When the battery runs down, the clock and timer functions do not operate properly. Contact your local dealer for the replacement of battery. The replacement must be carried out by a qualified service personnel.

Network PIN code setting

This is to set the Network PIN code to restrict the access from an unauthorized person through the network.

Enter a 4-digit number as the Network PIN code onto the text box and click **Set** button.

The network unit begins restarting and it takes about 20 seconds. Close (Quit) the web browser and access to the login page again in 20 seconds. This is to perform the login authentication firmly. The default Network PIN code [0000] means no Network PIN code is set.

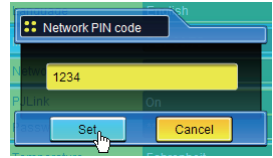

- ☞ When you connect the projector with this product to the network, it is recommended to set a new Network PIN code. Only a four-digit number is valid for the Network PIN code.
- ☞ If you forget the Network PIN code to the projector, you can check it by selecting "Network PIN code" sub menu from "Network" menu on the projector. For further information, please see item "Network PIN code setting" (p. 22).

PJLink and password setting

This is to set the PJLink password authentication on or off. If set "On" with the PJLink pull-down menu, the password must be required. Enter a **password*** onto the text box and click **Set** button.

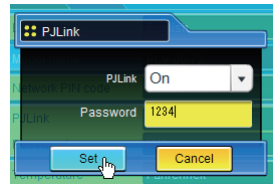

- ☞ 1 to 32 alphanumeric characters can be used for the password.

What's PJLink?

The projectors equipped with PJLink function can be used together on the same network, regardless of model or brand, for centralized control and monitoring. This standard was established by the Japan Business Machine and Information System Industries Association (JBMA).



Item	Description
Time settingWhen clicking AUTO button, the date and time set on your computer are set to the network unit
Current timeIndicates current date and time set on the network unit
DateSets date in manual
TimeSets time in manual

Date and time setting

Auto setting

Click **AUTO** button on the page, the date and time set on your computer are set to the network unit.

Note:

Confirm that your computer has a correct clock time before performing the auto time setting.

Manual setting

Click item **Date** or **Time** and enter date or time on the input box with adequate format.

Date is in year/month/day format.

ex. 2006/04/25

Time is in 24-hour:minute format.

ex. 18:30

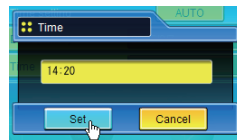
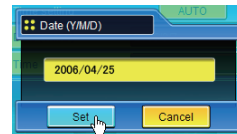



Network configuration

Click **Network** on the main menu. The following setting page is displayed. The IP Address, Subnet Mask, Default Gateway, DNS (Domain Name Server) and projector name are set up on this **Setting** sub menu.

The IP address and Subnet Mask have been configured already in chapter "Installation". If you want to change them or configure default gateway or DNS, perform them in this page. If you change them, the network unit begins restarting and it takes about 20 seconds. Close (Quit) the web browser and access to the login page again in 20 seconds.



Item	Description
IP address	Sets IP address of the projector
Subnet mask	Sets Subnet mask. Normally sets 255.255.255.0
Default gateway* ¹	Sets IP address of the default gateway (Router)
DNS* ²	Sets IP address of the DNS server. Must be set when using the e-mail function
PJ name* ³	Sets name of the projector. (64 characters maximum)
	You must use the number specified by your administrator. The address must be entered as a group with four numbers split by a dot like [192.168.001.101].

*1 Set [0.0.0.0] if the network does not provide the gateway (router).

*2 Set [0.0.0.0] if you do not use the function E-Mail alert.

*3 If you use the DNS server, register the host name registered to the DNS server as a projector name. You can access with this projector name from any computers in your network. If you do not use the DNS server, access with the assigned IP address to the projector.

* All the network setting will reset to the default when setting [0.0.0.0] of the IP Address.



E-mail setting

This product has an E-mail function which can send an alert message to users or an administrator if it detects an abnormality on the projector or run out of the life span of the lamp. Click **E-mail Setting** on the main menu and follow the below steps.

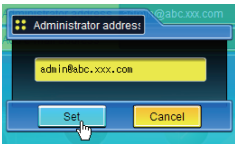

Item	Description
SMTP server*1Sets server name or IP address of the SMTP server
Administrator addressSets e-mail address of administrator
Add e-mail addressSets e-mail address of the user to send mail when the projector has an abnormality.

1 Setting SMTP server and administrator address

Set the server name or IP address of the SMTP server*1 and administrator address. The administrator address is set to "Reply-To" address of the message sent from the projector.

*1 The SMTP server is a server for sending E-Mail. Please contact your network administrator to have this SMTP server address.

- ☞ If the network unit sends an alert message due to the abnormality on the projector but the SMTP server is down in some other reason, the message will not be sent. In this case, the message "Unable to connect to server." will be displayed on the setting page. To clear this message, set up SMTP server address again.
- ☞ To use the E-Mail function, it must be set the DNS address on the Network setting page correctly.
- ☞ You cannot use this E-mail function if the DNS server and SMTP server cannot be used in your network environment.
- ☞ The projector does not send message to the address set in "Administrator address" text box. If you want to send e-mails to the administrator address, enter the administrator address into "Add e-mail address" text box.

2 Registering and deleting E-mail addresses

Click "Add e-mail address" and type the e-mail address onto the text box and click **Set** button. To check the registered addresses, click **Check/Delete** sub menu tab. The addresses are listed as the figure on the right.

☞ Up to 10 E-mail addresses can be registered.

To delete the registered addresses, check the address you want to delete and click **Delete** button.

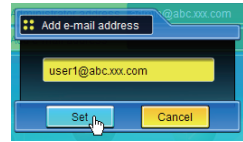

Check / Delete



Option

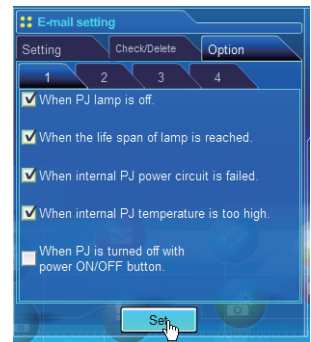

[1]-----

- When PJ lamp is off.
- When the life span of lamp is reached.
- When internal PJ power circuit is failed.
- When internal PJ temperature is too high.
- When PJ is turned off with power ON/OFF button.

[2]-----

- When Power management function turns PJ lamp off.
- When the signal is interrupted.
- When Auto Play is failed.

[3]-----

- When accumulated filter use time reaches [] hours.
- When filter is clogged.

[4]-----

- When lamp Corres. Value reaches [] hours.
- Attached message

☞ If condition "When Auto Play is failed" is checked, the trap is sent when occurring the error during the auto display operation using with the network viewer function (☞p.98). For further information of the error, refer to item "Auto Display setting and control page [3]"(☞p.101).

☞The length of message should be less than 256 characters.

☞ Up to 99,999 hours can be set for use time.

Examples: Type and contents of alert mail

When the projector has an abnormality, the following alert messages are sent to the registered E-mail address according to your selected condition. Administrator or user can take an efficient action quickly by receiving this message. This is very useful to maintain and service the projector.

The following are examples of received messages.

● When internal PJ temperature is too high:

TITLE: Message from projector
10-03-2005 00:59
Projector Model Name: *model name*
TCP/IP: 192.168.1.201 Projector Name: Proj05

It sends you following message.

*The Projector lamp is turned off, because internal Projector temperature is too high.
Wait for Temperature Warning Indicator turned off, and then turn the Projector on again.
If the Indicator continues flashing, check the air filter for dust accumulation.

[A] 81.5 degrees fahrenheit [B] 134 degrees fahrenheit [C] 95.6 degrees fahrenheit
Temperature of Sensor B is too high.

- ☞ The network unit let users know the information which thermal sensor [A], [B] or [C] inside the projector detected the abnormal temperature risen and so the projector was turned off. Please refer to item "Power control and status check" (☞ p.46) for the location of the sensors and each temperature. Also see the owner's manual of the projector for further details.

● When internal PJ power circuit is failed:

TITLE: Message from projector
10-03-2005 00:59
Projector Model Name: *model name*
TCP/IP: 192.168.1.201 Projector Name: Proj05

It sends you following message.

*The Projector lamp is turned off, because Projector power circuit is failed.
Unplug the Projector from AC outlet and ask servicing to qualified service personnel.

AV,	-5V	OK	} Error information
AV,	S5V	OK	
PJNET,	S5V	OK	
ANALOG,6V		NG	
....	

- ☞ The projector lamp was turned off, because the projector power circuit failed.
Unplug the projector from AC outlet and ask servicing to a qualified service personnel with the error information.

● When the life span of lamp is reached:

TITLE: Message from projector
 10-03-2005 00:59
 Projector Model Name: *model name*
 TCP/IP: 192.168.1.201 Projector Name: Proj05

It sends you following message.

*The life-span of lamp is reached.
 Lamp replacement is required.

- ✎ Replace it with a new lamp immediately and reset the lamp counter. If the projector is used without resetting the lamp counter, the alert mail is sent to users in every power-on of the projector. This alert mail will not be sent when unchecking the mail sending condition "When the life span of lamp is reached".

● When lamp corres. value reaches preselect use time:

TITLE: Message from projector
 10-03-2005 00:59
 Projector Model Name: *model name*
 TCP/IP: 192.168.1.201 Projector Name: Proj05

It sends you following message.

*The accumulated lamp use time reaches 1200 hours.
 Prepare for the lamp replacement.

Free messages

- ✎ The network unit sends a free message when the lamp use time (Corresponding value) reaches the preselected lamp use time. It can be used for preparation of the lamp replacement and the maintenance required.



SNMP setting

This product provides a SNMP (Simple Network Management Protocol) agent function. The SNMP consists of a manager and agents. The group which communicates information each other with SNMP is called "Community". There are two access modes in a community, Refer (read only) and Set (read-write). This product allows to use Refer (read only) only. The SNMP message informs the projector status called "Trap" to an administrator. Click **SNMP Setting** on the main menu and set up each item.

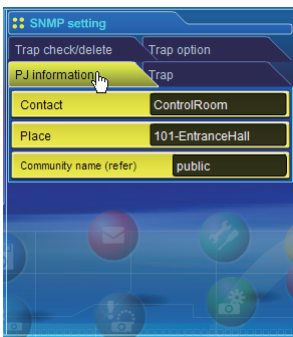

PJ information

Item	Description
Contact	Enter user name of the projector etc. (optional)
Place	Enter place of the projector (optional)
Community name(refer)	Enter community name (read only). Default name is "public".

☞ The SNMP agent provided with this product is based upon MIB-2 defined by RFC1213. For private MIB information, refer to file "Mibinfo/13PjNetPlus2.mib" in the CD-ROM.

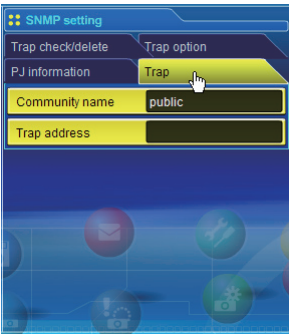

Trap

Item	Description
------	-------------

Community name	Enter community name to send "Trap". Default name is "public".
Trap address	Enter IP address of the SNMP manager computer to receive "Trap".

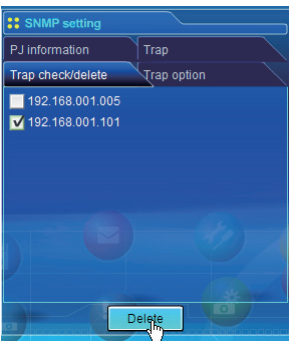

Trap check/delete

Check and delete the trap address

Checking the registered trap address and deleting the address.

To delete the address, tick check box in front of the IP address and click **Delete** button.

 Up to 10 trap addresses can be registered.

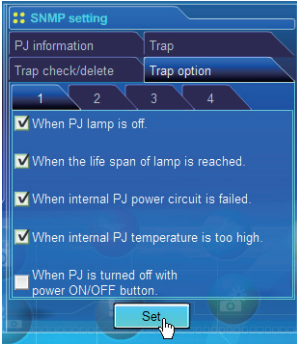

Trap option

Trap option setting

Tick check boxes in front of the condition item to send the trap.

Click **Set** button if you tick or un-tick the check box on a page.

[1]-----

- When PJ lamp is off.
- When the life span of lamp is reached.
- When internal PJ power circuit is failed.
- When internal PJ temperature is too high.
- When PJ is turned off with power ON/OFF button.

[2]-----

- When Power management function turns PJ lamp off.
- When the signal is interrupted.
- When Auto Play is failed.

[3]-----

- When accumulated filter use time reaches [] hours.
- When filter is clogged.

[4]-----

- When lamp Corres. Value reaches [] hours.

☞ "When PJ lamp is off" signifies the lamp goes out without user operation. "When PJ is turned into Standby in proper user operation" signifies that the projector is turned on by using the web browser and then it is turned into standby with ON/STANDBY button on the top control or the remote control.

☞ Up to 99,999 hours can be set for the time setting.

☞ If condition "When Auto Play is failed" is checked, the trap is sent when occurring the error during the auto display operation using with the network viewer function (☞p.98). For further information of the error, refer to item "Auto Display setting and control page [3]" (☞p.101).

4

Chapter 4 *Controlling the Projector*

Describes controlling and setting of the projector by using the web browser.



Power control and status check

Click **Power & Status** on the main menu. The control page will be displayed.

By clicking **ON** or **Standby** button on the page, the power of the projector can be controlled.

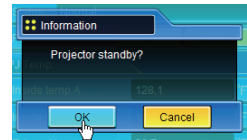

Pop up confirmation window

Item	Description
------	-------------

PJ status

- PowerDisplays the status of the lamp. (ON, OFF, On starting up, On cooling down)
- StatusDisplays the status of the projector's power. (Refer to next page.)
- Power controlControls the projector power by clicking the "ON" or "Standby" button.

PJ temp.

- Inside temp.ADisplays the surrounding temperature of lamp in the projector. (Sensor B)
- Inside temp.BDisplays the surrounding temperature of panel in the projector. (Sensor C)
- External temp.Displays the surrounding temperature of the intake vent. (Sensor A)



.....The warning icon will appear if the temperature exceeds a specified value. Check if there is no object to obstruct the airflow around the intake or exhaust vent. It might be airfilter clogged. Clean up the airfilter.

* The temperature unit can be set either Centigrade or Fahrenheit in item "Initial Setting". (p.34)

About projector condition

Status	Description
Normal.....	Projector is operating normally.
Power management in operation.....	Power management is operating
Lamp failure.....	Lamp failure is occurring
Abnormal Temperature.....	The temperature of the projector became too high
Cooling down after abnormal Temp.....	Projector detects abnormal temp. and is cooling down itself.
Standby after Abnormal Temp.....	Projector detects abnormal temp. and sets into standby mode.
Power failure	Power failure has occurred inside the projector. Projector is turned off. Disconnect the AC cord and ask servicing to a qualified service personnel.

If the power failure occurs on the projector, "Power failure" is indicated on the status column and the information icon appears on the power column as shown below. Click this icon to display further information of the power failure.

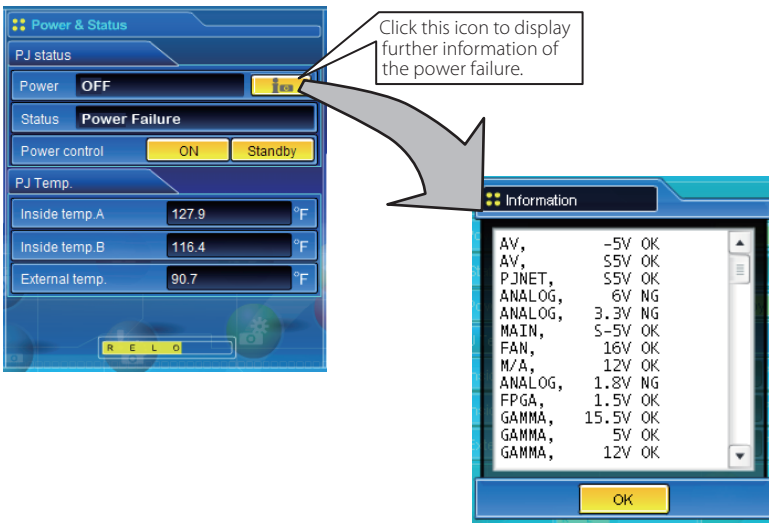

When a security (PIN code lock) has been set on the projector, you also cannot control it through the network. To control the projector through the network temporarily, execute "PJ lock suspend" command to unlock the security. "PJ lock suspend" is on setting sub menu [3] on Setting main menu. (p.54)

- ☞ The projector cannot be turned on while the projector is on cooling down.
- ☞ The web browser checks and updates the projector's condition every 30 seconds automatically.



Controls

Click **Control** on the main menu. The setting method differs depending on the contents of the page. Click on the page number to change pages and select desired setting items.

Please see the owner's manual of the projector to have the further information of each control item.



Input

This function is to select the input mode and source mode of the projector. Click **Set** button after selecting the input and source mode.



Item	Description
Input.....	Selects input mode of the projector. (1 to 4)
Source.....	Selects signal source of the input.
	Input 1 : RGB(PC analog) RGB(Scart) RGB(PC digital) RGB(AV HDCP)
	Input 2 : RGB Video Component
	Input 3 : Auto Video S-video
	Input 4 : Network

The control page displays valid control items depending on the selected input mode, signal or functions of the projector you use, therefore, there may be different controls between the described items and actual control items on the page display. For further information, refer to the projector's owner's manual.

When the projector is in standby, only the timer on the setting menu is effective; others are inactive.

System

This function is to select the system of signal input to the projector. The available system mode are listed on the pull-down menu button according to the input signal. Select a system and then click **Set** button.

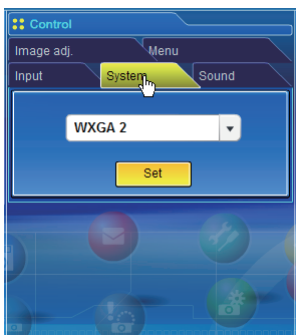

Available selection at the RGB(PC analog) input

Item	Description
XGA1	It automatically switches to the proper computer system of the input signal. * The computer system modes (VGA, SVGA, XGA, SXGA, UXGA, WXGA...) which meet the input signal are listed.

Available selection at the RGB(PC digital) input

Item	Description
D-XGA.....	It automatically switches to the proper computer system of the input signal. * The computer system modes (D-VGA, D-SVGA, D-XGA, D-SXGA1...) which meet the input signal are listed.

Available selection at the Video/S-video/Scart input

Item	Description
AUTO.....	It automatically switches to the proper color system of the input signal. * The selectable color systems are PAL, SECAM, NTSC, NTSC4.43, PAL-M and PAL-N. * AUTO is fixed at the Scart input.

Available selection at the RGB(AV HDCP) input

Item	Description
AUTO.....	It automatically switches to the proper scanning system of the input signal. * The selectable scanning systems are D-480p, D-575p, D-720p, D-1035i and D-1080i.

Available selection at the Component input

Item	Description
AUTO.....	It automatically switches to the proper scanning system of the input signal. * The selectable scanning systems are 480i, 575i, 480p, 575p, 720p, 1035i and 1080i.

If the mode (Mode1 to Mode 10, ExMode11 to ExMode50) which is stored in the item "PC Adjustment" (p.52) is available, they are also listed together with the above mode.

Image adjustment

This function is to adjust the projected picture image and save the image mode. To store the adjusted value, click **Store** button, and to load the adjusted value, click **Load** button.

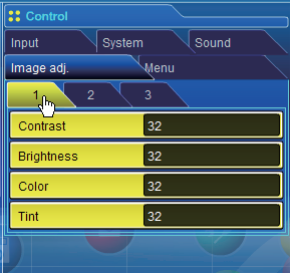

Item	Description
Contrast	Adjusts picture contrast (0~ 63)
Brightness	Adjusts picture brightness (0~ 63)
Color.....	Adjusts picture color saturation (0~ 63)
Tint.....	Adjusts picture hue (0~ 63)

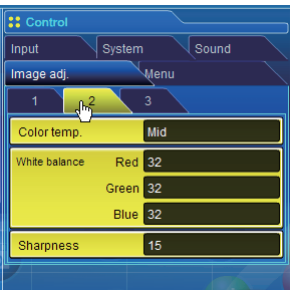

Item	Description
Color Temp.	Sets a color temperature mode. (X Low, Low, Mid, High, Adj.)
White Balance Red, Green, Blue.....	Adjusts each white balance respectively. (0~ 63)
Sharpness.....	Adjusts picture sharpness. (0~ 31)

* When changing the value of the white balance, the color temp. indicates "Adj."

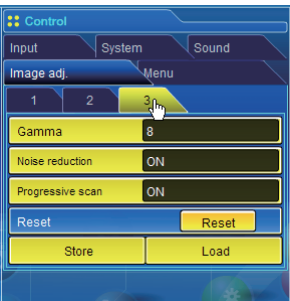

Item	Description
Gamma.....	Adjusts brightness of darker part of the picture. (0~ 15)
Noise reduction ..	Switches noise reduction mode (OFF, L1, L2)
Progressive scan...	Switches progressive mode (OFF, L1, L2, Film)
Reset.....	Resets the Image adjustment to previous levels.
Store.....	Stores the Image adjustment values. Select an item [Image1 - Image4] from the pull-down menu and click Store button.

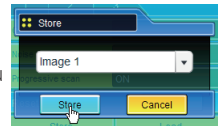

Load.....	Loads the Image mode. Select an image mode from the pull-down menu and click Load button. There may not be available mode depending on the input mode as shown in the table left.
-----------	--

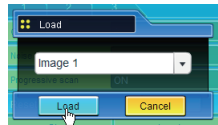

Input source Image mode	Video Computer	
	Video	Computer
Standard	✓	✓
Cinema	✓	*
Real	*	✓
Dynamic	✓	✓
Image1 - 4	✓	✓

☞ The mark "✓" means that the available image mode in the selected input source. The error message appears when selecting the disabled image mode indicated with "*".

Sound

This function is to adjust the sound of the projector. The values in the text box represent the current control value or status.

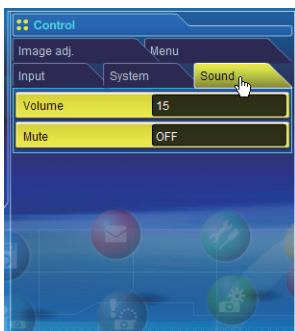

Item	Description
Volume	Adjusts the sound volume from the speakers.(0 ~ 63)
Mute.....	Suppresses the sound. (ON, OFF)

Menu

This function is to control the On-screen menu of the projector. Switches menu on/off, moves menu selection (cursor) and executes the selected menu item.



Item	Description
Display	Switches the on-screen display menu on or off by clicking ON or OFF button.
Cursor.....	Moves cursor selection by clicking ◀▶▲ and ▼ buttons and executes the selected menu item by clicking ■ button.



PC adjustment

Click **PC Adj.** on the main menu. This function is to adjust the signal from the computer connected to the projector to obtain the proper picture image on the screen.

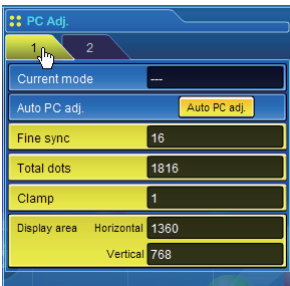

Item	Description
Current mode	Displays a current mode like VGA, SVGA, XGA, SXGA, UXGA, WXGA, etc. or MODE1 - MODE10, EXT11 - EXT50 which are the customized mode created by using the "Mode Store" function described below. EXT51 - EXT60 represents mode Totalsave 1 - Totalsave10 used in the item "Save" (p.55).
Auto PC adj.	Performs automatic adjustment.
Fine sync	Performs Fine Sync adjustment.(0 ~ 31)
Total dots	Adjust the number of total dots in the horizontal period.
Clamp	Adjusts the phase of the clamp. (1 ~ 255)

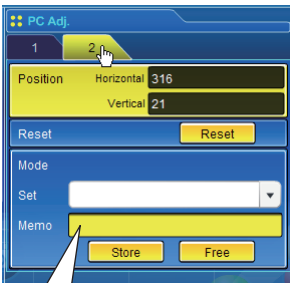

Display area	
Horizontal	Adjusts the image area horizontally.
Vertical	Adjusts the image area vertically.

Item	Description
Position	
Horizontal	Adjusts the horizontal position of the screen.
Vertical	Adjusts the vertical position of the screen.
Reset	Resets the PC adjustments to the previous levels.
Mode Store	Stores the PC adjustment values. Select a mode no. [Mode1 - Mode10, ExMode11 - ExMode50] from the pull-down menu.
Mode Free	Clear the PC adjustment values. Select a mode no. [Mode1 - Mode10, ExMode11 - ExMode50] from the pull-down menu.

Up to 60 characters can be used for the Memo of ExMode11 to ExMode50.



Setting up the projector

Click **Setting** on the main menu. This function is to set up the projector. Select the sub menu [Screen setting] or [Setting] and then set up each setting.

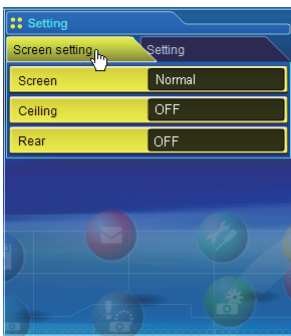

Item	Description
Screen	Switches the screen mode. (Normal, Wide, True, Full screen, Custom*) There may not be available mode depending on the input mode as shown in the table below.
Ceiling	Sets the image top/bottom and left/right reversed. (ON, OFF)
Rear	Sets the image left/right reversed. (ON, OFF)

Screen mode	Input source	
	Video	Computer
Normal	✓	✓
Wide	✓	✓
True	*	✓
Full screen	*	✓
Custom* ¹	✓	✓

☞ The mark "✓" means that the available screen mode in the selected input source system. The error message appears when selecting the disabled screen mode indicated with "x".

*¹ This item may appear only if the projector supports.

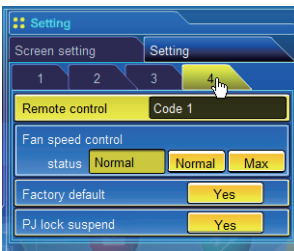
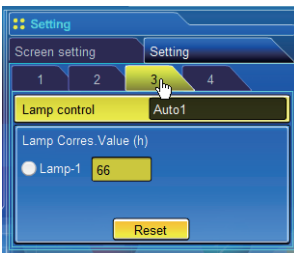
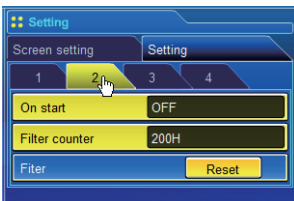

Item	Description
Logo	Sets on or off the logo display on the screen during the startup. (Default, User, OFF)
Background	Sets screen background to blue when no signal input. (Blue, User, Black)
Display	Switches on or off the on-screen menu display on the screen.(OFF, CountdownOff, ON)
Freeze	Sets the image to freeze mode.(ON, OFF)
Power management	Sets into the selected power management mode (OFF, Ready, Shutdown) if the input signal is interrupted and no control key is pressed for the specified period of time. *The specified time can be set 1 to 30 min.

Item	Description
On start	Sets the power-on mode when connecting the AC cord to the outlet. (ON, OFF)
Filter counter	Sets the time to indicate the filter warning message on the screen. (Off, 100H, 200H, 300H)
Filter	Click Reset button to reset the filter use time.

Item	Description
Lamp control	Selects lamp control mode. (Auto1, Auto2, High, Normal, Eco, Eco1, Eco2, etc.) * The available items depend on the projectors.
Lamp Corres. Value(h)	Displays the lamp use time (Corresponding value) . Reset the time after lamp replacement.

Lamp Corres. Value Reset

1. Select a Lamp-1 radio button and then click **Reset** button.
2. Click **OK** button to execute the reset.

Item	Description
Remote control ID	Sets the remote control ID.(Code 1 - Code 8)
Fan speed control	Sets the fan control speed. (Normal, Max) Status Indicates the current fan mode.
Factory default	Sets all of the projector control items to the factory default setting except the following items. Lamp Corres. Value, PJ time, Network PIN code, Network setting * This function is not effective for the settings of the network unit, Network address settings, e-mail settings, etc.
PJ lock suspend	When the projector has a security of PIN code lock, disable this function temporarily by pressing Execute/Yes button.

Setting procedure

1. Turn off the projector , disconnect AC cord from the outlet and then connect AC cord again.
2. Access this page with the web browser,
3. Click **Execute/Yes** button on the PJ lock suspend.
* This function is disabled after the projector turns on.



Save the controls and settings

This page is to save and load the controls and settings of the projector in the block. The storable items are "PC adjustment", "Control" and "Setting".



Store/free the settings

- 1 Click Save menu on the main menu.
- 2 Select a set number (Totalsave1 to Totalsave10) you intend to store current settings with the pull-down menu button of the item **Store & Free**. Name this set number onto the Memo text area.
* Up to 18 characters can be used for the Memo.
- 3 Click **Store** button to store the current setting and name into the selected set number.
To remove the saved setting, select the set number with pull-down menu button and then click **Free** button.

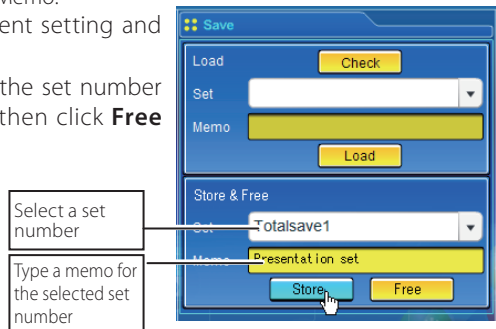

☞ You can store up to 10 (Totalsave1 to Totalsave10) sets of settings into the network unit. Totalsave1 to Totalsave10 are indicated on the item "Current mode" of the PC adjustment (p.52) as the EXT51 to EXT60.

Check the saved items

Click **Check** button to check the current setting condition of the controls. Each item of "PC adj.", "Control" and "Setting" is displayed sequentially.



Click **Stop** button to cancel the auto page display.

Load a control set

Select your desired set number (Totalsave1 to Totalsave10) with the pull-down menu button of **Load Set** and then click **Load** button. The setting values of the selected set number are applied to the current settings.



Select a set number

⚠ If the contents of the saved set are not matched for the inputs equipped on the projector, the invalid alert message may be displayed.



Timer setting

This page is to set the timer to turn the projector off or on at a programmed day/date and time. Follow the steps below for setting. Click **Timer** on the main menu.

The screenshot shows the 'Timer' setting window. A callout box at the top points to the 'Current time' field, which displays '2005/9/9(Fri) 14:21:36 ON/DPP'. Below this, the 'Timer setting' section has two radio buttons: 'Date' (selected) and 'Day of the week'. Under 'Date', the date '2005/9/9' is entered in a text field. To the right, there are two pull-down menus for selecting a day. Below the date field, the 'Time' is set to '14:21' in a text field. The 'Action' is set to 'ON' in a pull-down menu. At the bottom of the window are 'Set' and 'Check' buttons. Callouts on the right side of the window point to the 'Date' radio button, the 'Day of the week' pull-down menu, the 'Time' text field, and the 'Action' pull-down menu.

How to set the timer

1 Set a day or date

To set the timer event at same time everyday or every week,

Select **day** entry with radio button and then select desired day with the pull-down menu button.

The selectable days are as follows:

- Same time everyday - Every week (days from Monday to Sunday)

To set the timer event on specified date,

select **date** entry with radio button and then type the date with (Year/Month/Date) format.

Ex.: Type [2005/12/20] if you specify [December 20, 2005].

2 Set an execute time

Type the time with (Hour:Minute) and 24 hours format.

Ex.: Type [18:25] if you specify [PM 6 o'clock and 25 minutes].

3 Select an event action

Select an event action from the pull-down menu.

Event	Action
ON.....	Turns on the projector
OFF.....	Turns off the projector
Lamp Auto1	Changes lamp mode to "Auto1"
Lamp Auto2	Changes lamp mode to "Auto2"
Lamp High	Changes lamp mode to "High"
Lamp Normal.....	Changes lamp mode to "Normal"
Lamp Eco	Changes lamp mode to "Eco"
Lamp Eco1	Changes lamp mode to "Eco1"
Lamp Eco2	Changes lamp mode to "Eco2"

*Available events depends on the projector function.

4 Register an event

Click **Set** button to register the set timer event. Repeat steps 1 to 4 for another timer event setting.

Check the timer events

To check the set timer events, click **Check** button. The timer events are listed. The event with blue background color represents the timer-OFF event.

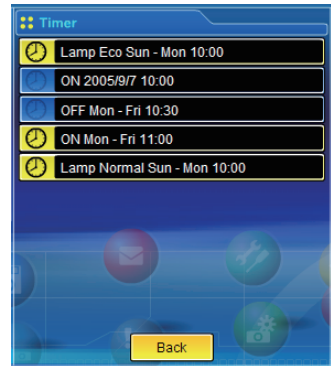

Change the event mode

On the event list appearing by clicking **Check** button, click on the event you want to delete, disable or enable. Click **Cancel**, **Delete**, **Timer ON** or **Timer OFF** button on the popup pallet.

Button	Operation
Cancel.....	Cancels the setting
Delete.....	Deletes the timer event
Timer OFF.....	Disable the timer event temporarily
Timer ON.....	Enable the timer event

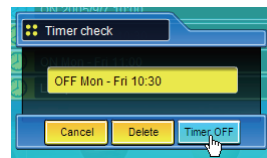

Notes on timer setting

Up to 10 timer events can be registered. Timer events always operate according to the next valid event depending on the projector's power status. In the example below, event 3 turns on the projector so next event 4 (also turning on projector) will not be effective because the projector is already turned on. Similarly, when the projector is turned off by event 5, event 6 OFF will not be effective in turning it off again. But these secondary events (event 4 and event 6) will become effective if a person turns off the projector (after event 3 and before event 4) or turns on the projector (after event 5 and before event 6).

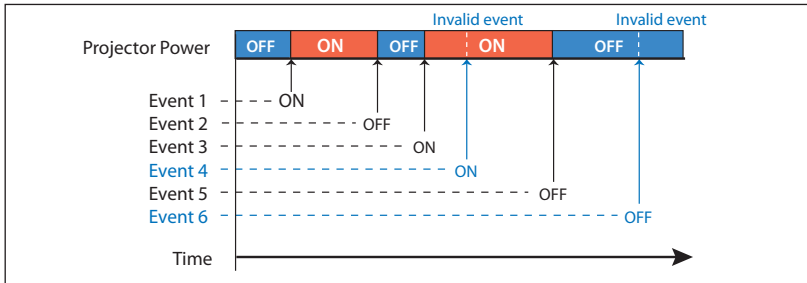

- When the timer events are set at the same time, the last event set will override the previous events. For example, if there is an event like "ON at 8:00 everyday" and then new event is set like "OFF at 8:00 everyday", only the last setting event is effective.
- When the timer event **ON** occurs during cooling down period, this is invalid event because the projector cannot be turned on during this cooling down period.

The timer operates by using the clock function provided in this product. Before setting the timer, please confirm that the current date and time are set correctly. Timer and clock functions are functioning using a lithium battery provided in this product. When the battery runs down, the clock and timer functions will not operate correctly. Consult your local dealer for the replacement of battery. The replacement must be carried out by a qualified service personnel.



Projector information



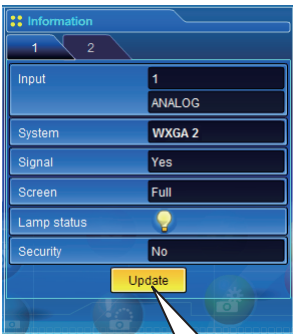



This page is to display the basic information of the projector status. Click **Information** on the main menu.



Click this button to update the information

Items	Description
Input.....	Displays selected input and source.
System.....	Displays selected signal system.
Signal.....	Input signal status (Yes, No)
Screen.....	Displays screen mode.
Lamp status.....	Displays lamp status with an animation. Refer to the table on the next page.
Security.....	Displays the security (PIN code lock) status (Yes, No)



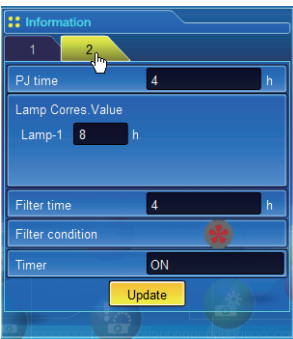

Indication of the lamp status

Icon display/background	Status
 White-Yellow/Blue	Lamp on (Normal)
 White-Yellow/Red	Lamp on (Lamp is being used over a specified use time, replace lamp immediately)
 Gray/Blue	Lamp off (Normal)
 Gray/Red	Lamp off (Lamp is being used over a specified use time, replace lamp immediately)
 Red/Blue with X	Lamp failure (Lamp failure, check lamp condition)
 Red/Red with X	Lamp failure (Lamp failure and lamp is being used over a specified use time, replace lamp immediately)



Items	Description
PJ time	Displays the accumulated use time of the projector.
Lamp Corres. Value	Displays the use time (Corresponding value) of the lamp.
Filter time	Displays the use time of the filter.
Filter condition	Displays the filter condition with an animation.
Timer	Displays the timer setting status. ON Timer has been set. OFF No timer setting.

Indication of the filter status

Icon display/background	Status
 Blue	Good condition. Fan speed is normal.
 Blue	Good condition. Fan speed is maximum.
 Yellow/Gray	Filter is almost clogged. Fan speed is normal.
 Yellow/Gray	Filter is almost clogged. Fan speed is maximum.
 Red/Gray	Filter is clogged. Clean up the airfilter.



Multi-control

Controlling and setting the multi-projectors

This function enables you to control the multiple projectors equipped with the network units that are connected to the network. Click **Multi Control** on the main menu to display the control page.

Note:

To control the multiple projectors, each projector must have the same Network PIN code.



Example of multi control

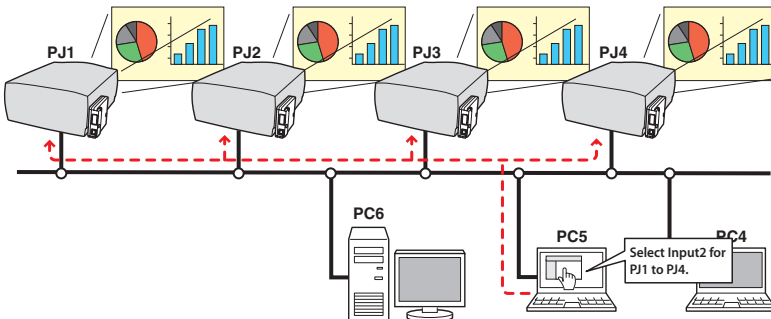

Start/stop the multi control

To start or stop controlling the multi-projectors, click Multi control setting menu and select ON or OFF.

Multi control setting

OFFStops multi control function

ONStarts multi control function. The multi control menu will appear when setting ON. These items of menu are linked to the main menu.

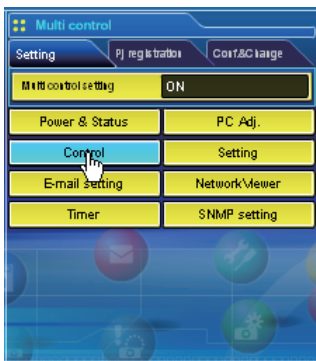
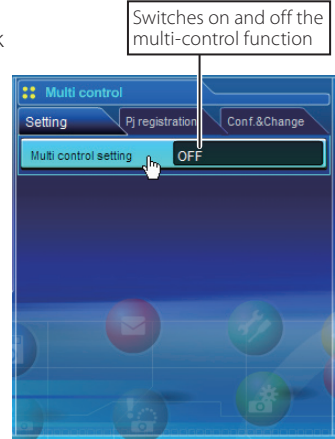
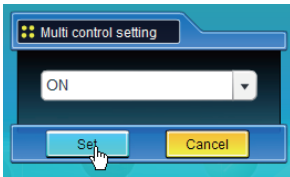

The multi controllable menus are "Power & Status", "PC adjustment", "Control", "Setting", "E-mail setting", "Timer", "SNMP setting" and "Network Viewer". Click each menu and perform setting and adjustment.

✎ The word "MULTI CONTROL" appears on the each control page while the multi control is operating.

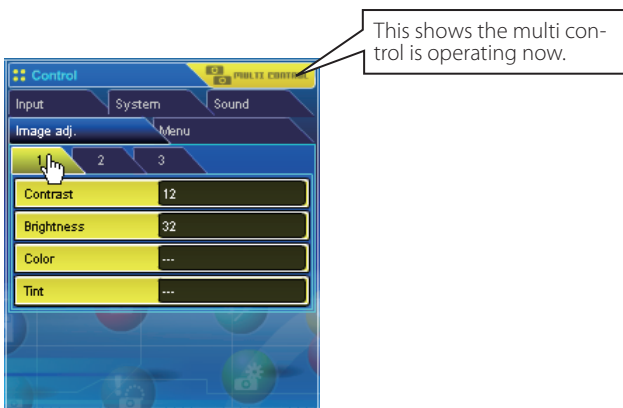

Register the projector

To use the multi control function, register the IP address of the projector you intend to control. Click **PJ registration** sub menu tab and set the IP address, Memo and Multi control item, then click **Set** button.

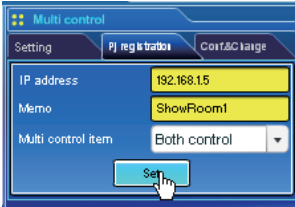

Items	Description
IP address	Enter IP address of the projector to control
Memo	Enter projector name or installed location etc.
Multi control item	
Control	Controlling the projector
Both control	Controlling and displaying images (XG250/XG300)
Visual control	Displaying the images (XG250/XG300)
Control&Image	Controlling and displaying images (XG400/SXG400)
Image.....	Displaying the images (XG400/SXG400)

*Item name differs depending on the projector's type.

Confirmation of registered projector

To check the registered information, click **Conf. & Change** sub menu tab. The registered information of the projector is listed as the below.

* The word "none" is displayed if not using the "Memo" function.

* When you click on a listed IP address, the login page for the selected projector will be displayed with a new window.

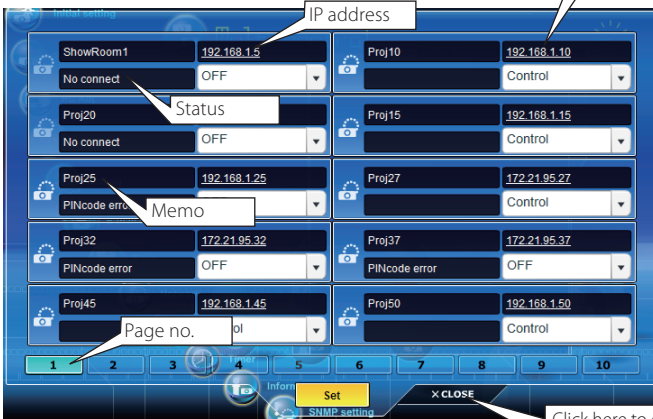

Click here to close the sub menu Conf. & Change.

10 projectors per page can be registered and up to 100 sets can be registered for the multi-control.

Change the mode of the registered projector

To change the mode of the registered projector, select a mode with the pull-down menu button under the IP address of the target projector and then click **Set** button.

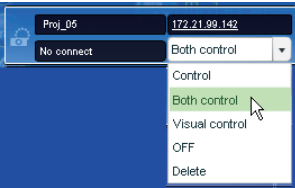

Mode	Operation
Control.....	Controlling the projector
Both control.....	Controlling and displaying images (XG250/XG300)
Visual control.....	Displaying the images (XG250/XG300)
Control&Image.....	Controlling and displaying images (XG400/SXG400)
Image.....	Displaying the images (XG400/SXG400)
OFF.....	Excluding from the multi-control
Delete.....	Deleting from the multi-control

* Mode name differs depending on the projector's type.

* The multi control item is not changed during using the network viewer function. It is not available with the light mode.

Status

If some of the registered projectors are disabled by some reasons (such as disconnecting the power source, disconnecting the LAN cable, disconnecting from the network), control changes will continue to be effective for the projectors that are still active. At the same time, the deactivated projectors are excluded from the multi-control. The status of the registered projectors are indicated under the projector name. See the table below for status indications.

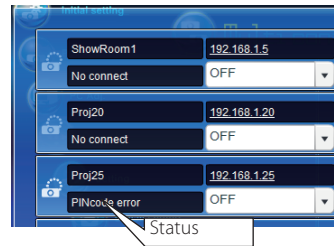

Status	Description
(blank).....	The projector is connected to the network correctly
No connect.....	The projector may not be connected to the network. Please check the connection and network configuration of this projector.
PIN code error.....	The PIN code is incorrect. The PIN code for the multi-controlled projectors must be the same. Change the PIN code of this projector to the common PIN code.
File Error.....	Not displaying the images. Check if this projector is using the Network Capture function or Network Viewer function individually, or in the standby mode.

* The network unit updates the status at the time when the multi-control function was executed.

- ☞ If the multi-controlled projector is in the standby mode, any change is not effective except timer setting.
- ☞ Cannot register, delete or change the multi-control setting during using the network viewer function.
- ☞ It is recommended that a specified projector should be chosen for setting as a master when you use this multi-control function. The control for the multi-controlled projectors will become too complicated operation if this function is used for each projector.
- ☞ If the registered projector is not connected to the network, it will take some time to complete the multi-control operation because of waiting for the response from each registered projector.
- ☞ There are some disabled items in the multi-control function for the light mode.

Conf. & Change page in the light mode

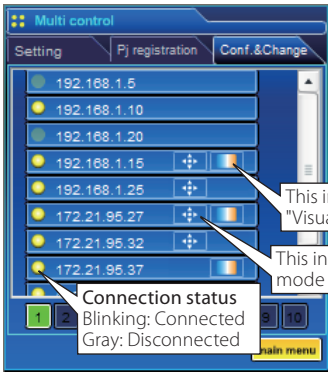

Following functions in the "Conf. & Change" page are not available in the light mode.

- Changing the control mode.
- Deleting the registered IP address
- Indicating the each status
- Indicating the each memo

Controlling all together

"Power & Status", "PC adjustment", "Control" and "Setting" can be controlled all together. Set "ON" the multi control setting and adjust controls of each menu. The setting value is applied to the registered projectors sequentially.

☞ This is effective only if the multi control item of the registered projector sets to either "Both control/Control&Image" or "Control".



Setting all together

"E-mail setting", "SNMP setting" and "Timer" can be set all together. Set "ON" the multi control setting and items of each menu. The setting value is applied to the registered projectors sequentially.

☞ This is effective only if the multi control item of the registered projector sets to either "Both control/Control&Image" or "Control".

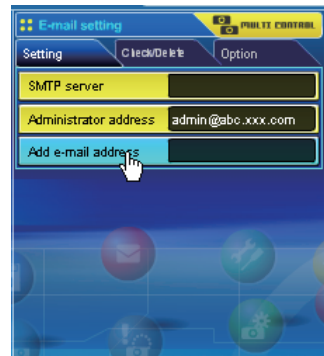

Viewer auto setting all together

"Viewer auto display" can be set all together. Set "ON" the multi control setting and select **[3] Auto display** from **Viewer** sub menu (selected by 'Multi-control' - "Network Viewer" menu). Set the display time periods and repeat times for the auto image display. When clicking **Start** button, the registered projectors start playing back the auto image display in sequential.

- ☞ For further information of the Auto display, see "Using the network viewer function". (p.98)
- ☞ This is effective only if the multi control item of the registered projector sets to either "Both control/Control&Image" or "Visual control".

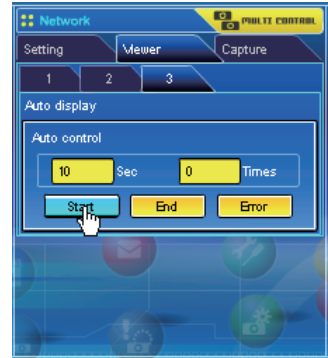

5

Chapter 5 *Network Capture*

Network Capture is a function to display the screen image of the computer via the network.

- Real Time Capture
- Network Communication

About Network Capture function

The Network Capture is a function to project the screen images of the computer which has a Network Capture 3 software by the projector through the network. This function has 2 kinds of mode as the below.

- Real Time Capture (☞ p.72)

A function to display the screen image of the computer by the projector through the network in real time.

- Network Communication (☞ p.77)

This mode is to communicate by sharing the capture image of a computer with multiple computers and a projector. User can draw the text and figure on the captured image by using a drawing tool.

☞ Up to 30 computers can be registered.

☞ The Network Capture function cannot be used when using the Network Viewer function. The Real Time Capture and Network Communication mode cannot be used at the same time.

Launching the Network Capture 3

After installing the Network Capture 3 software, the shortcut icon is copied into the "Startup" folder. When you boot the computer, the Network Capture software also starts and its icon stays on the task bar. If the icon is not appeared on the task bar, the Network Capture 3 software is not starting. Click "Network Capture 3" from "Start" - "All the Programs" - "Network Viewer & Capture 3" menu to launch it manually. The status which the Network Capture 3 icon stays on the task bar is just preparing the screen capturing.



Commands on the task bar

When clicking the **Network Viewer & Capture 3** icon on the task bar, The popup menu will appear as the right. See the next page for each operation.

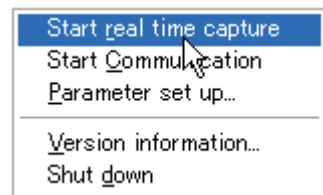

Items	Description
Start real time capture	Starts the real time capturing. (☞ p.72) The screen image of the computer is projected on the screen in real time.
Start communication	Starts the Network Communication. (☞ p.77) Captured image is projected on the screen. The captured image edit window appears on the computer screen.
Parameter set up.....	Sets the communication parameter between the computer and network unit of the projector. For further information, see item "Parameter set up" below.
Version information.....	Displays the version of this software.
Shut down	Quits the application.

Parameter set up

- 1 Click **Network Capture 3 icon** on the task bar.
- 2 Click "Parameter set up" on the popup menu. The setting window will appear.
- 3 Set **Capture Port** and **PIN code** to match to the projector's port number and Network PIN code.
 - ☞ To check the Capture Port number, see item "Control by the web browser" (☞ p.74). To check the PIN code, see item "Network PIN code setting" (☞ p.22).
 - ☞ Specify the port number of TCP/IP. The default port setting is 9000. There are some reserved port numbers and also some applications may use their own port numbers. If one of those port numbers is used, the alert dialog window will appear and let you know that it is an invalid port number. In this case, use another port number.
 - ☞ The reserved port numbers are http (80), ftp (21), telnet (23), etc. The port no. 4352, 10000, 10001 are reserved to control the projector through the LAN port.
- 4 Click **Search** button to list up the available IP address assigned to the projector and select desired IP address you use, or you can enter the IP address or host name manually if you know that IP address or host name.
 - ☞ It may not find any address over the router. Consult your network administrator for further details.
- 5 Set the quality of the image.
 - Quality:** Selects from High, Mid, Low
 - Image Scaling:** If checked, the screen image size of the computer is automatically adjusted to the projector's screen size.
- 6 Set capture start time in second unit.
 - ☞ This is effective in the communication mode only. It sets up the time period from executing the command "Capture transfer" to capturing and transferring the actual screen image. 0 to 60 seconds can be set.
- 7 Click **OK** button to close the setting window.

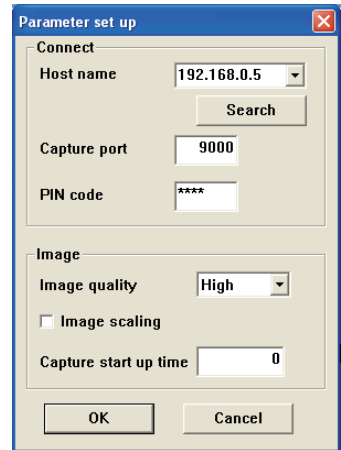

About Image Quality

- Quality** : Quality mode of the captured image shows following JPEG compression mode;
- High** : JPEG low compression mode
- Medium** : JPEG medium compression mode
- Low** : JPEG high compression mode

Using the Real Time Capture

This is a function to project the screen image of the computer by the projector in real time. The captured image projected by the projector can be selected from the computer, web browser and the projector respectively.

Registering the computers

Up to 30 computers can be registered.

1 Access to the control page of the projector by using the web browser. From the **Network** menu, click **Capture** tab to display the setting page (p.37).

2 Switch to **Connection Setting** page by clicking the page number tab [3]. Enter the IP address of the computer to the PC number, and then click **Set** button. Click **Set** button to register the IP address for each page.



- ☞ The registered computer enables to start capturing if only the Network Capture icon appears on the task bar.
- ☞ The transfer speed of the captured image using the Real Time Capture function is depending on the network environment and data volume of the image. For example, when transferring an image (Computer resolutions and colors: XGA, full color, Picture quality: High), the transfer speed is about 2 pages per second in maximum. It cannot be supported for movie pictures.
- ☞ The mouse pointer on the computer's screen cannot be captured.

[1] Control by the computer

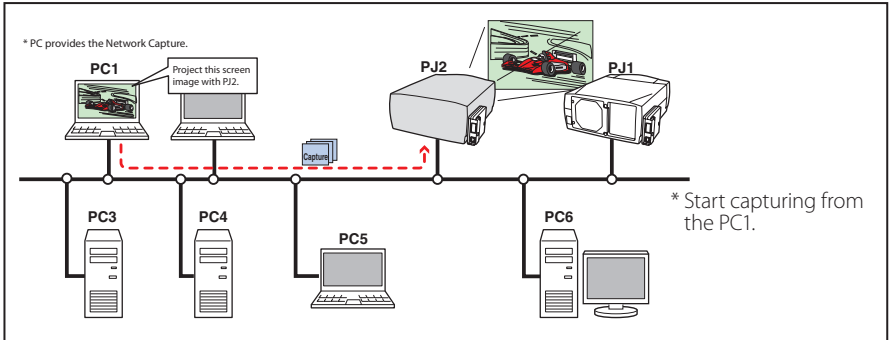

Select input mode to "Network" previously.

1 Click **Network Capture 3** icon on the task bar.

2 Click **Start real time capture** on the popup menu.

The screen image of the computer will appear on the projected screen in real time.

- To stop capturing, click **Stop real time capture** on the popup menu. The captured image of the computer on the screen is frozen.
- To restart capturing, click **Restart real time capture** on the popup menu.

3 To end capturing, click **End real time capture** on the popup menu.

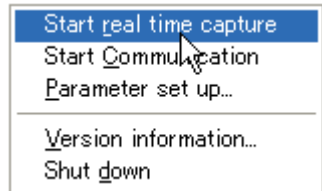

Icon on the task bar



Standby

Capturing

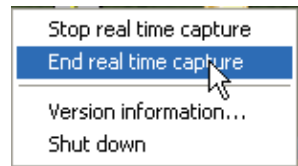

If the Network PIN code set on the projector differs from PIN code set on the parameter setting up, The Pin code setting window appears. Enter a correct PIN code and click **OK** button.

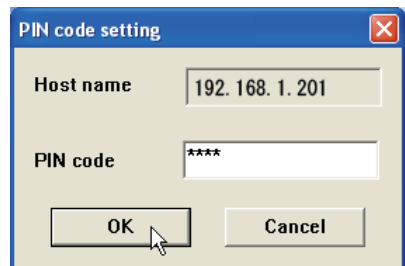

☞ If the error message appears, check item "Parameter set up" (p.71).

[2] Control by the web browser

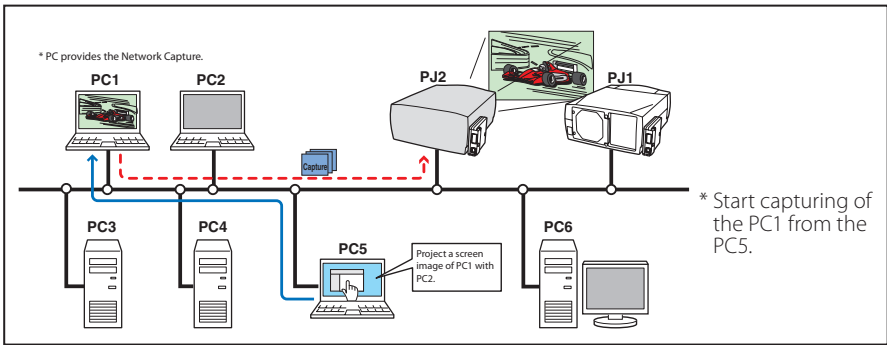

Select input mode to "Network" previously.

- 1 Access to the control page of the projector by using the web browser. From the **Network** menu, click **Capture** tab to display the setting page (☞ p.37).
- 2 Select the computer number from the pull-down menu button of "Connecting PC" and click **Start** button. The screen image of the selected computer will appear on the projected screen in real time.
 - To stop capturing, click **Stop** button. The captured image of the computer on the screen is frozen.
 - To restart capturing, click **ReStart** button.
- 3 To end capturing, click **End** button.

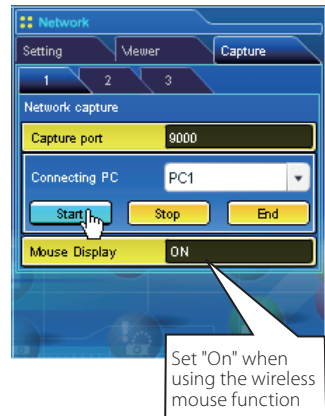

- ☞ The IP address of the connecting PC should be registered previously (☞ p.72).
- ☞ If the error message appears, check item "Parameter set up" (☞ p.71).
- ☞ You can use the capture function by using the web browser or the projector if the Network Capture 3 software is installed into the computer correctly and its icon stays on the task bar.

[3] Control by the projector

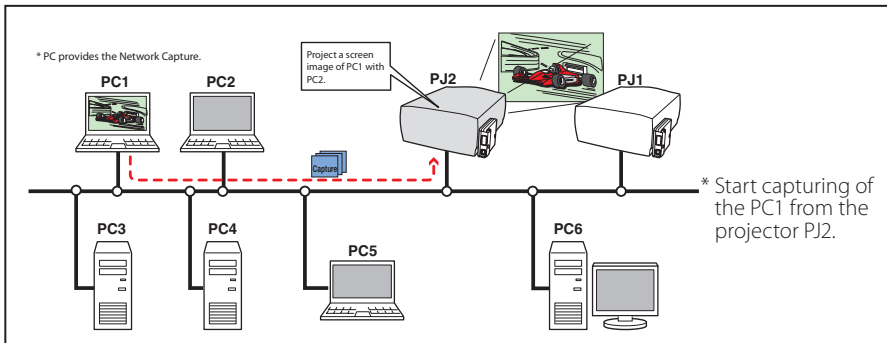

Select input mode to "Network" previously.

- 1 Select "Network Capture" icon from "Network" menu. Press **SELECT** button on the projector twice to display the network capture setting pallet.
- 2 Select PC number to connect .
- 3 Select "Connect" and then press **SELECT** button to start capturing. The screen image of the selected computer will appear on the projected screen in real time.
- 4 To end capturing, select "Disconnect" and then press **SELECT** button.

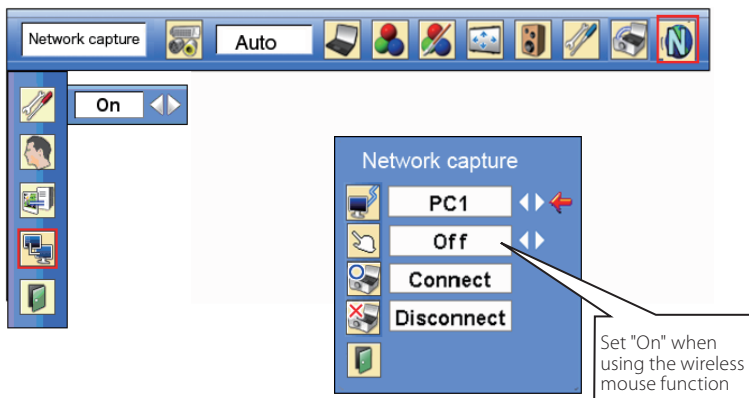

- ☞ The IP address of the connecting PC should be registered previously (☞ p.72).
- ☞ If the error message appears, check item "Parameter set up" (☞ p.71).
- ☞ Selectable computer from the projector is PC1 to PC10. Other PCs cannot be selected from the projector.
- ☞ The projector does not provide the function to register the IP address of the computer and to set the parameter of the capturing. They should be registered by using the web browser previously (☞ p.71-72).

Advanced using example

Displays the presentation data stored in the computer by using the wireless mouse function from the projector.

1 Start capturing of the computer PC1 by using the projector.

Select "Network Capture" icon from the menu and select "PC1" and then select "Connect" (☞ p.75).

⇒ The Network Capture software installed in the selected computer will start capturing.

2 On the PC1 capture image projected on the screen, search a presentation file data stored in the PC1 by using the wireless mouse function of the remote control supplied with the projector.

3 Select a desired file and double click with the remote control .

⇒ The application by which the document was created starts and the projector projects the presentation picture on the screen.

4 Start the presentation.

⇒ By using wireless mouse function, control the page browsing and some other operations for the PC1.

☞ For further instructions of the wireless mouse, please refer to the projector's owners manual.

☞ On the projected screen using with the network capture, the shape of the mouse pointer differs from the one on the computer's screen.

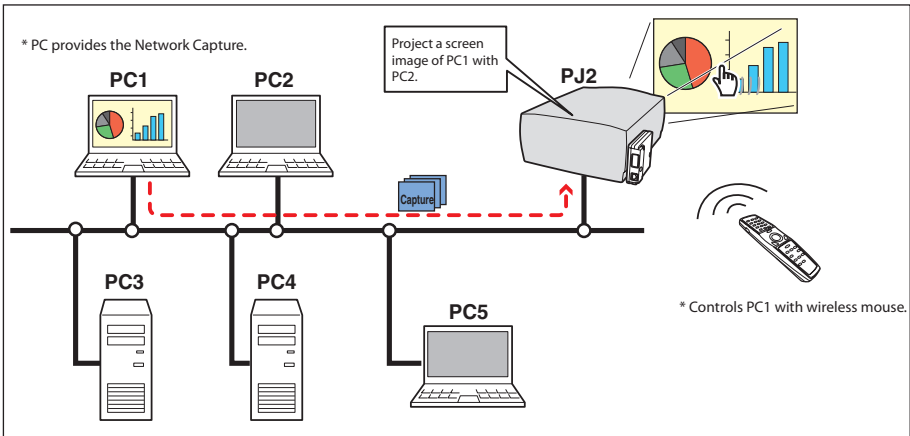

Setting condition

Projector

Input mode: Network

Network Unit

Registering the connection: The IP address of the computer and proper parameter must be set to the PC1 (☞ p.71-72).

Mouse Display: "On" (☞ p.74, p.75)

Computer PC1

Software: The Network Capture software is installed correctly and its icon appears on the task bar.

Using the Network Communication

This Network Communication is to communicate by sharing the captured image of a computer with multiple computers and a projector. User can draw the text and figure on the captured image by using a drawing tool.

The data that has the captured image of a Main PC and communication information is sent to the projector. The projector projects this data onto the screen and serves this data to other computers (Sub PC) at the same time. The Sub PC receives served capture data and displays it on the screen. The Main PC and Sub PC also can edit the captured image by using the drawing tool. This edited image is applied to all the computers automatically.

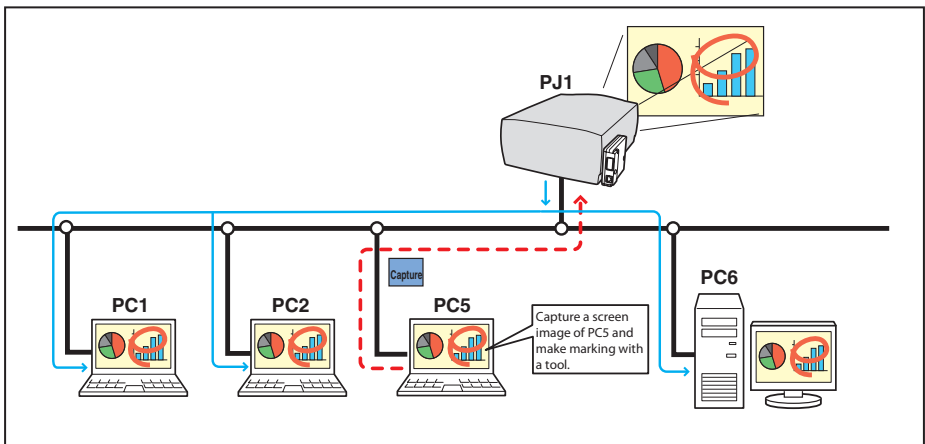

* The Main PC is a computer which started using of communication function, and serves own computer screen captured image to the Sub PC. The Main PC has an authority to quit using whole of communication. To become the Main PC, execute the command "Start Communication" or "Capture transfer". For further information, see item "How to use the Network Communication". (p.81)

* The Sub PC is a computer which receives a captured image from the Main PC. On the communication mode, the Sub PC can become the Main PC anytime.

Settings before using the Network Communication

To use the Network Communication, the capture setting of the network should be set either [1] or [2] described below.

[1] Setting the network unit searches all the available subject computers in the network automatically.

or

[2] Setting the subject computers are registered to the network unit.

Perform capture setting following to the description below.

[1] When serving the capture data to all the subject computers in the network.

By using the web browser, display "Communication Setting" from menu "Network"->"Capture"->"Page 2". Confirm that the item Auto search subject PC is "ON". If "OFF", change mode to "ON".

* Network unit can find up to 30 computers in the network.

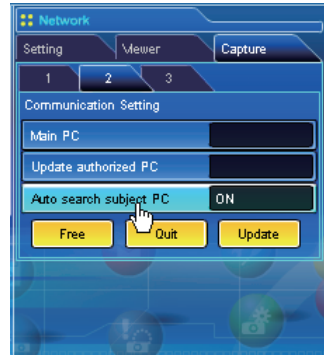

[2] When serving the capture data to the specific subject computers in the network.

Set item Auto search subject PC is "OFF" described in the above and then display "Connection Setting" from menu "Network"->"Capture"->"Page 3" with the web browser. Enter the IP address of subject computer and click **Set** button to register.

* Up to 30 computers can be registered to the network unit.

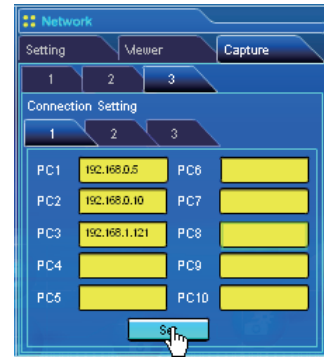

Description of capture editing window

Select menu "Start Communication" from the popup menu appearing by clicking the Network Capture 3 icon on the task bar. The capture editing window will appear on the computer screen as the below. For basic operation of each menu, refer to the item "Menu tree" below.

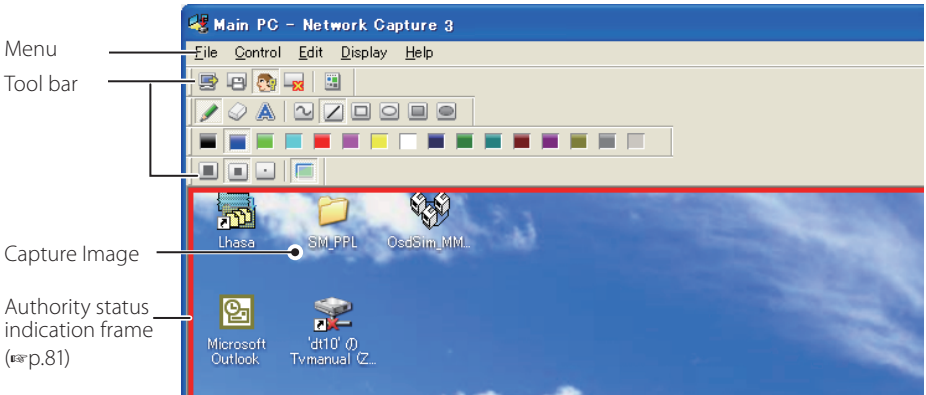

Menu tree

Menu	Submenu	Operation	
File	Save Communication	Saves a captured editing image as the data(JPEG) Save dialog window appears	
	End Communication <small>* main pc only</small>	Quit the communication mode	
	End Editing <small>* sub pc only</small>	Close the Editing window	
Control	Capture transfer	Captures a screen image and sends it to the network unit	
	Authority	Acquire/release the authority to edit the capture image	
Edit	Tool	Pencil	Selects a pencil tool
		Eraser	Selects an eraser tool
		Letter frame	Selects a letter frame tool
	Form (Shape)	Free	Draws line with freehand
		Straight line	Draws straight line
		Square	Draws square
		Oval	Draws oval
		Square(Painting out)	Draws filled square
	Oval(Painting out)	Draws filled oval	
	Attribute	Appears a attribute window	
	Delete all	Delete all the drawings on the image	
Undo	Cancel the last executed operation		
Display	Full screen	Switches capture editing window, normal or full screen	
	Tool bar	Standard	Switches standard tool buttons on or off
		Form(shape)	Switches form(Shape) tool buttons on or off
		Color	Switches color tool buttons on r off
		Attribute	Switches attribute tool buttons on or off
Display on foreground	Keeps capture editing window on foreground always		
Help	Version information	Displays software version number	

Tool bar button names

The following commands are assigned to the tool bar buttons. For each operation, refer to the description of item "Menu tree".

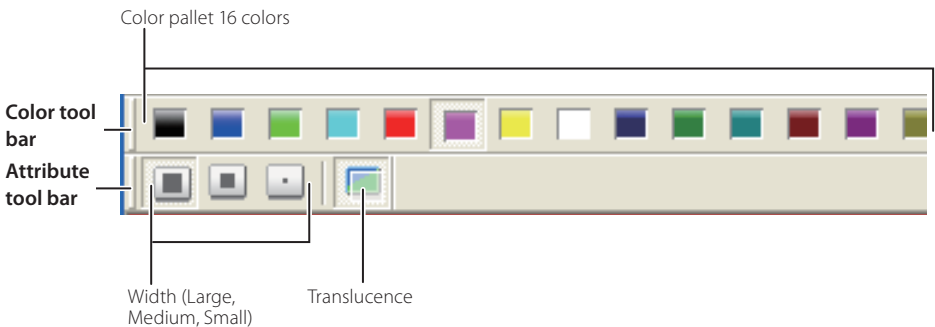
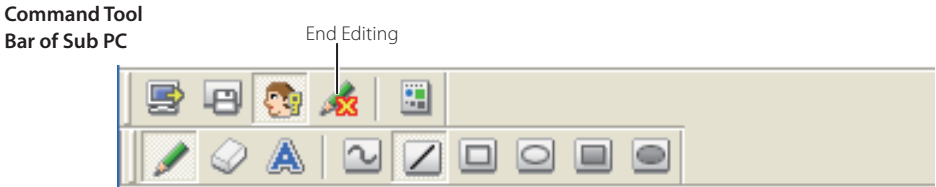
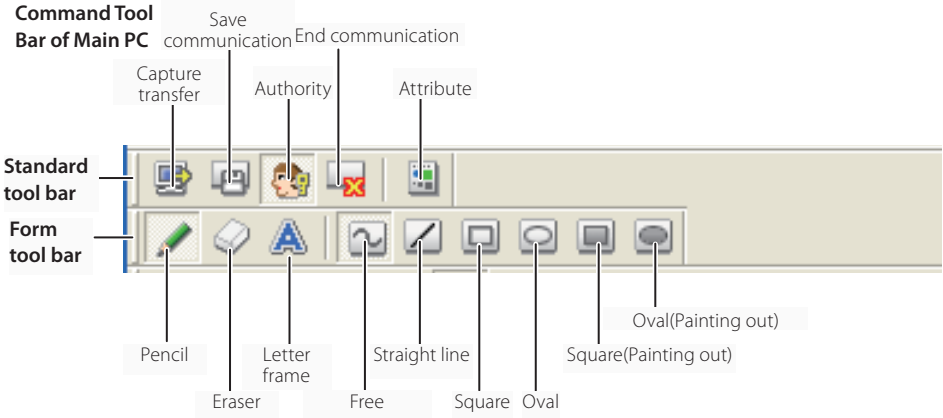

- ☞ To switch the tool bars displaying on or off, select each command from menu "Display"->"Tool bar".
- ☞ User can realign and join the tool bars (Standard, Shape, Color, Attribute), and change it to the floating pallet by taking a drag and drop of the tool bars.
- ☞ There are some disable buttons depending on the tools and authority mode. In this case the button indicates with gray.

How to use the Network Communication

Start the communication

- 1 Display an image on the computer screen.
- 2 Select **Start Communication** from the popup menu appeared by clicking **Network Capture 3** icon on the task bar. The capture editing window with a captured image appears on the computer screen.

- ☞ If an error message appears, check item "Parameter set up". (p.71)
- ☞ The icon on the task bar is activated during the network communication operates.

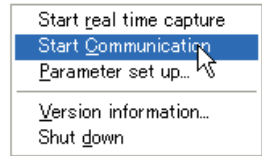

Icon on the task bar



Standby Communication

Join the communication (only for Sub PC)

- 1 Network Capture 3 icon is activated to inform users in the network that the Network Communication is operating. Display the popup menu by clicking its icon.
- 2 Select **Start editing** menu. The capture editing window with a captured image appears on the computer screen.

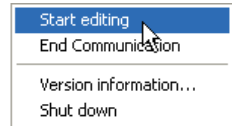

Exit from the communication (only for Sub PC)

Click "End editing" button on the standard tool bar. The capture editing window will be closed.

- ☞ This command is available with the Sub PC only.
- ☞ When executing "End editing" with the authority provided, the authority will be released.

End the communication

Click "End communication" button on the standard tool bar. The capture editing window will be closed.

- ☞ This command is available with the Main PC only.
- ☞ It cannot be ended the communication while other PC has the authority. To end communication forcibly, click the Capture 3 icon on the task bar and select "Shut down" on the popup menu.

Acquire and release of editing authority

To edit the capture image, each computer needs to acquire the authority respectively. To acquire the authority, click "Authority" button on the standard tool bar and then edit the capture image. The capture editing window indicates the authority status by changing the frame color according to the current authority mode as follows.

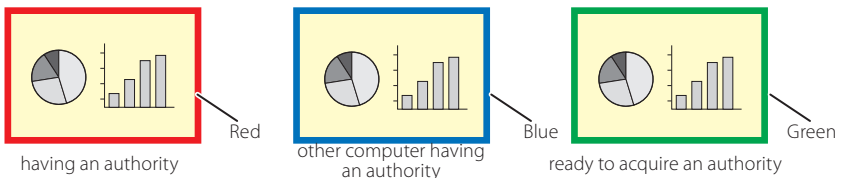

Edit capture image

Drawing figures

- 1 Click "Pencil" button on the form tool bar.
- 2 Select its attribute (shape, width, color and translucence) from the form and attribute tool bar.
- 3 Drag a mouse pointer on the screen image to draw the figure.

Erase drawn object

- 1 Click "Eraser" button on the form tool bar.
- 2 Select its attribute (shape, width) from the form and attribute tool bar.
- 3 Drag a mouse pointer on the screen image to erase the figure.

Hints of the drawing

- ☞ Straight line tool..... To draw the vertical line or horizontal line, drag a mouse pointer with shift key pressed.
- ☞ Square tool..... To draw the quadrate rectangle, drag a mouse pointer with shift key pressed.
- ☞ Oval tool..... To draw the perfect circle, drag a mouse pointer with shift key pressed.
- ☞ To cancel the drawing, select command "Edit"->"Undo" from the menu.
- ☞ To erase all the drawing at once, select command "Edit"->"Delete all" from the menu.
- ☞ The popup menu appeared by right clicking of the mouse is also available to select the tool and change the attribute.

Setting of the drawing tool attribute

When clicking "Attribute" button on the standard tool bar, the following window will appear. This window appears only if the pencil or eraser tool is selected.

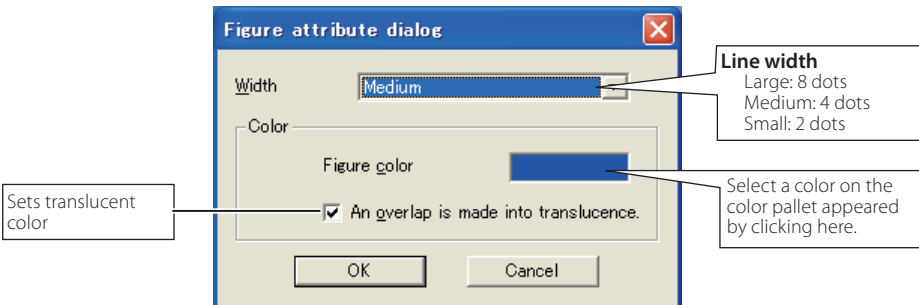

Drawing letter

- 1 Click "A:Letter frame" button on the form tool bar.
- 2 Select a color of text with color tool bar.
- 3 Drag a mouse pointer on the screen image to specify the area of the letter frame. The letter input dialog window will appear.
- 4 Enter the letter onto the window.
To change the letter attribute, click **Letter attribute** button. See item "letter attribute setting" below.
- 5 Click **OK** button to fix the content. The entered letter appears on the captured image.

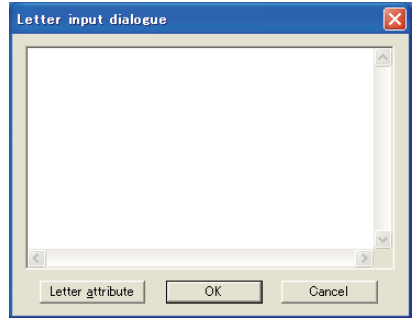

- ☞ If the entered letter overflows the area of letter frame, the letter frame is automatically extended downward.
- ☞ Up to 1000 characters can be used for a letter frame.

Letter attribute setting

The font attribute setting window appears when clicking "Attribute" button on the standard tool bar with the letter frame tool selected, or clicking **Letter attribute** button on the letter input dialog window described the above.

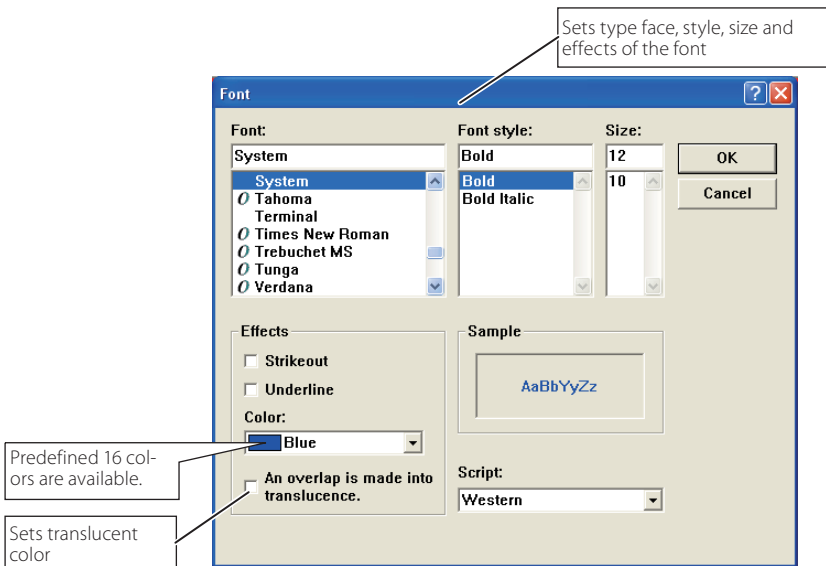

Network Communication operation and change of state

Network Communication can be used under the environment which one or more computers are connected to the projector via the network.

Preparation

Launch the Network Capture 3 software on the subject computer (p.70). Set the projector in the standby or turning on. Check IP address of the subject computer is registered in the connection list (p.78).

		Operation on the Main PC		Operation on the Sub PC	
On the Communication	<ol style="list-style-type: none"> 1 Executing the command "Start Communication". → The capture editing window appears on the screen. The icon on the task bar is activated. 	Frame	→ The icon on the task bar is activated to let users know that the captured image is now serving.	Frame	
		R	<ol style="list-style-type: none"> 1 Executing the command "Start Editing". → The capture image on the Main PC appears on the screen. 	B	
	<ol style="list-style-type: none"> 2 Editing the capture image using with the tools. → The editing information is automatically transferred to the Sub PC. 	R	→ The editing information on the Main PC is reflected on the Sub PC.	B	
	<ol style="list-style-type: none"> 3 Releasing the editing authority. → The color of authority status frame changes green. 	G	→ The color of authority status frame changes green.	G	
	→ The color of authority status frame changes blue.	B	<ol style="list-style-type: none"> 2 Acquiring the authority. → The color of authority status frame changes red. 	R	
	→ The editing information on the Sub PC is reflected on the Main PC.	B	<ol style="list-style-type: none"> 3 Editing the captured image using with the tools. → The editing information is automatically transferred to the subject PC. 	R	
	→ The color of authority status frame changes green.	G	<ol style="list-style-type: none"> 4 Releasing the editing authority. → The color of authority status frame changes green. 	G	
	<ol style="list-style-type: none"> 4 Acquiring the authority. → The color of authority status frame changes red. 	R	→ The color of authority status frame changes blue.	B	
	<ol style="list-style-type: none"> 5 Repeat steps 2, 3 if required. 		<ol style="list-style-type: none"> 5 Repeat steps 2 to 4 if required. 		
	<ol style="list-style-type: none"> 6 Executing the command "Capture transfer". → Updating the editing window with a new captured screen image. 	R	→ A new captured screen image appears on the editing window.	B	
	<ol style="list-style-type: none"> 7 Repeat steps 2 to 5. 				
	<ol style="list-style-type: none"> 8 Ending the communication. → The capture editing window disappears. 	R	→ The capture editing window disappears.		

- ☞ The projector projects the edited captured image on the screen when the input mode of the projector is set "Network".
- ☞ The command "Save Communication" can be executed in any of the mode even if not having the authority.
- ☞ The arrow (→) shows a response to the command executed.
- ☞ The execution of the command "End Communication" or "End Editing" on the Sub PC has no effect on the other subject computers.

Executing the forcing mode

The network capture setting of the web page provides a forcing executing command. This command executes the release of authority or ending the communication forcibly. This is useful when the other subject PC keeps an authority all the time, or when the condition of the communication is not stable.

Click page 2 **Communication Setting** from the menu "Network"->"Capture". Execute command by clicking the button **Free**, **Quit** or **Update**.



Displays IP address of the Main PC

Displays IP address of the computer has a editing authority

Item	Description
------	-------------

- | | |
|--------------|---|
| Free | Releases the editing authority forcibly
→ Sets condition which all the users can acquire an authority |
| Quit | Quits the communication forcibly
→ The capture editing window on all the computers closes forcibly. |
| Update | Acquires the latest communication status
→ Updates the IP address of the Main PC and Update authorized PC. |

Error information

Error messages	Cause and corresponding
Set up the parameter.	Error when executing the communication. The parameter setting (host name, capture port) has not been set. → Check parameter setting (p.71)
It has not been registered to PJ as a group.	Error when executing Start Communication or Start real time capture. The IP address of the computer has not been registered. → Register the IP address by using the web browser (p.78)
Cannot be displayed as PJ is under display.	Error when executing Start Communication or Start real time capture. The other capture, viewer or advanced card imager function is now operating. → Wait until the communication function is available.
Cannot connect to PJ.	Cannot establish the connection with the network unit when executing the Start communication, End communication, Capture transfer, Start real time capture or End real time capture. → Check connection of the network cable.
Cannot transfer data to PJ.	Cannot transfer the data to the network unit when executing the Start Communication, End Communication, Capture transfer, Start real time capture or End real time capture. The time out period is 10 seconds. → Check connection of the network cable.
Cannot receive data from PJ.	Cannot receive the data from the network unit when executing the Start Communication, End Communication, Capture transfer, Start real time capture or End real time capture. The time out period is 10 seconds. → Check connection of the network cable.
Other PC has authority. Cannot complete "Network Communication".	When executing the End communication, you cannot quit the communication because other computer has an authority
Other PC has authority. Cannot obtain authority.	Other computer has an authority.
The server name or address could not be resolved.	When setting the parameter, the computer cannot find the setting host name or IP address in the network. → Use available host name or IP address.
Invalid port number	When setting the parameter, the reserved port number is specified. → Check parameter setting (p.71)
PJ has not started Network Communication. Close the window and open it again.	The projector might have turned off during the communication. → Check projector power and restart executing "Start communication".

6

Chapter 6 **Network Viewer**

Network Viewer is a function to display the image data stored in the file servers by the projector through the network.

Describes about file converter software File Converter 1, File Converter 2 and program creator software Program Editor, and how to use Network Viewer.

Creating the available data [Network Viewer 3]

The image available with this projector is the JPEG format (.jpg). There are several types of JPEG data. Before using the images with the Network Viewer function, it should be converted to the optimized JPEG data for this projector.

[1] How to use the Network Viewer 3 (File Converter 1)

The File Converter 1 is a software to convert from the JPEG, bitmap or Power Point data to the optimized JPEG data for the projector.

Launch and quit the File Converter 1

To launch the File Converter 1, click "Network Viewer 3 (File Converter 1)" menu from "Start" - "All Programs" - "Network Viewer & Capture 3" menu.

To quit the File Converter 1, click on the close box on the upper right hand of the window.

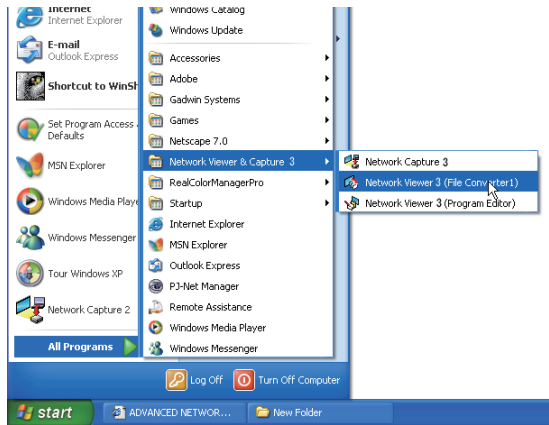

File Converter 1 window

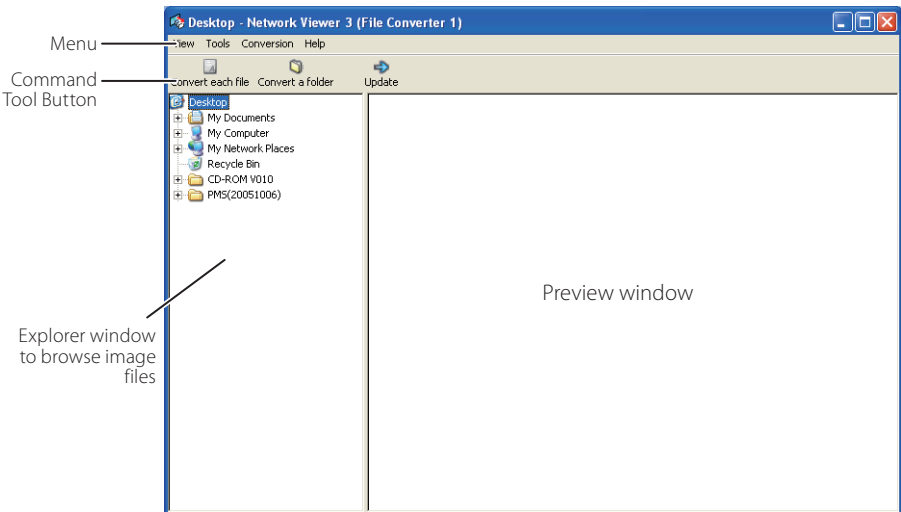

Menu Tree

Menu	Sub Menu	Description
View	Update	Updates contents of the preview window
	Preview size	Sets size of the preview image, Large, Middle, Small
Tools	Option	Sets default of the output destination and conversion mode
	Conversion	Converts files in a folder into JPEG files at once.
Conversion	Convert a folder	Converts a file into a JPEG file individually
	Convert each file	Converts a file into a JPEG file individually
Help	Version information	Displays the version information

Command Tool Button

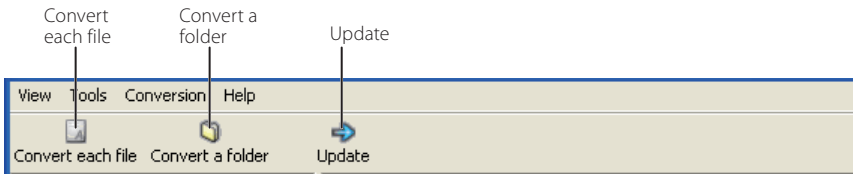

Create the available data

I Select a folder in which the image files are stored by the explorer window.

The preview images of the available image data (JPEG file, Bitmap file, power point file) in the selected folder are displayed on the preview window.

✎ On the preview window, the preview displayed with the red frame represents a file not optimized JPEG file or Bitmap file for the projection. The preview without the red frame represents the optimized JPEG file for the projection. So you do not need to convert them again, but if you change the size or image quality, perform to convert them again.

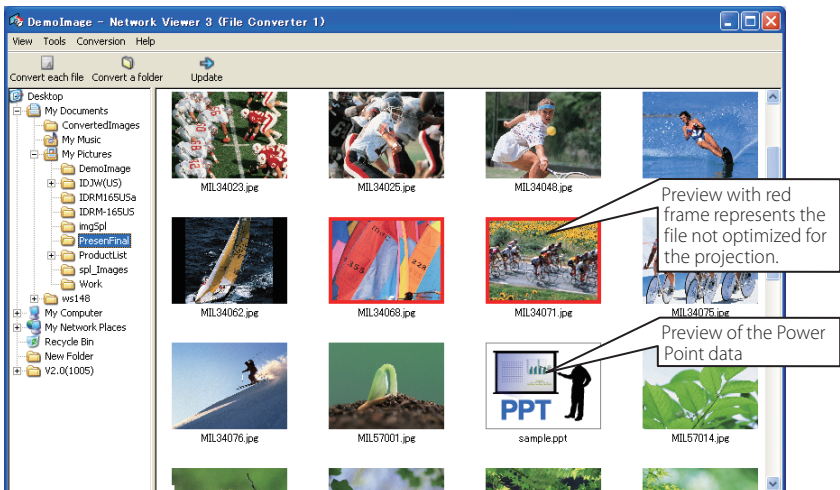

2 When converting each file, select a preview image first and then click **Convert each file**.

To select two or more files at once, press and hold "Shift" key or "Ctrl" key and then click the preview images.

When converting all the files in a folder, select a folder and click **Convert a folder**.

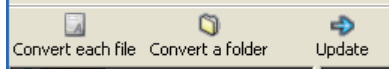

3 As the confirmation window appears, check the conversion object and conversion type and then click **OK** button. The File converter 1 starts converting and stores the optimized files into the output folder. It enables you to select a local hard disk of your computer, shared computer in the network, a directory of the FTP server. To change the conversion type or output destination, click **Change** button.

If the power point file is included in the conversion object, the Microsoft Power Point software will be launched and start converting automatically.

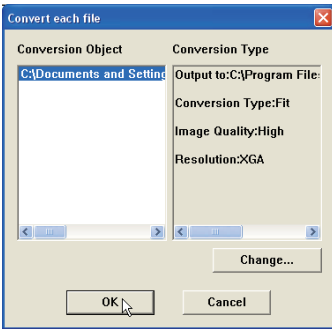

Dialog window when using "Convert each file" and "Convert a folder"

To convert images from the power point file, Microsoft Power Point software is required in your computer.

In the power point file conversion, all the pages are converted into JPEG files separately.

Setting of output destination and conversion mode

When clicking **Change** button on the confirmation window in the step 3 on the previous page, following option setting window appears.

Output destination

Select either **Folder** or **FTP server** as the output destination of the converted files.

Folder

Output folder.....Specify a folder in the local hard disk or shared computer in the network

FTP server

Host name.....Enter host name or IP address of the FTP server

Root Folder.....Specify the root directory of the FTP server. Normally use "/".

User ID.....Enter your login account of the FTP server.

Password.....Enter your password of the FTP server.

Output folder.....Specify a directory of the FTP server.

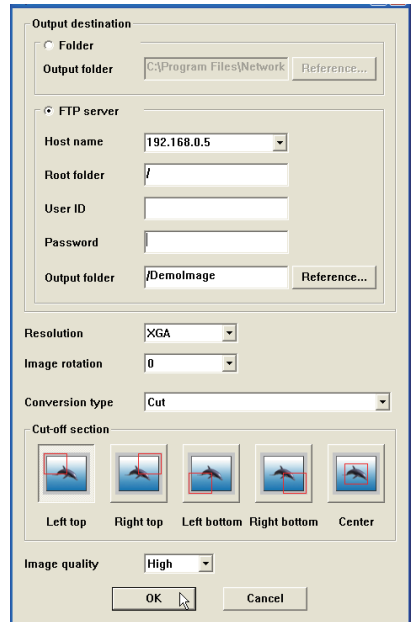

Conversion mode

Resolution.....Selects output image resolution (VGA to XGA)

☞ The image resolution higher than the projector's panel resolution cannot be displayed.

☞ SXGA and SXGA+ signals are invalid when selected.

Image rotation.....Selects image rotation (0, 90, 180, 270).

Conversion Type

Fit..... Converts as either width or height of the image sets to be the maximum screen width or height.

Justify

[both ends]..... Converts as width of the image sets to be the maximum screen width.

Justify

[top and bottom]..... Converts as height of the image sets to be the maximum screen height.

Cut..... Cuts image with the screen size not depending on the image size. This type has several modes, see figure right.

☞ Select this mode when you want to have the images with the original size. Select each mode by clicking on the button.

Image Quality.....Selects an image conversion quality with "High", "Mid" or "Low".

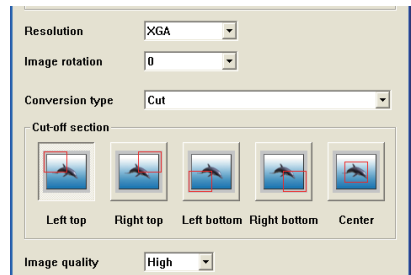

[2] How to use the Network Viewer 3 (File Converter 2)

The File Converter 2 is a kind of the printer driver software to convert to the optimized JPEG data for the projection from the any documents created by the other software such as text editor, spreadsheet or presentation software. It is possible to convert to the JPEG file from the any kinds of documents created by the software which has a "print" menu.

Create the available data

- 1 Open a document with the individual software.
- 2 Select a "Print" sub menu and open the printing dialog. On the window, select "Network Viewer 3 (File Converter 2)" icon on "Select Printer" item and click **Print** button.

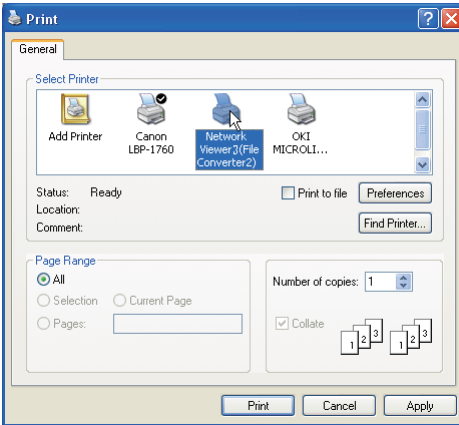

☞ Set the option setting for the page layout or paper setting by clicking **Preferences** button if required.

- 3 Select a folder and click **Save** button.

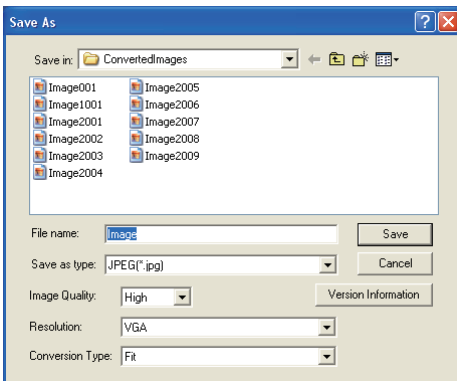

☞ The file name is named with "Image001" as the default. If the converted image has 2 or more pages, the file names are numbered from "001" to "999" in a sequential order.

☞ Image quality and Conversion type can be setup on this window. For further information, please see "Setting of the Conversion Mode" (# p.91).

☞ It may appear the white space around the edges on the converted image depending on the type of the image data.

☞ The above procedure may differ from each computer environment and applications.

Creating a program file [Program Editor]

Network Viewer 3 (Program Editor) is a tool to make a program file which specifies the display order of the image and its file path in the file server (FTP server). The Program Editor makes a folder "DispParam" at the login root directory in the FTP server and makes files as each program name into this folder. These files are called "Program". By specifying the program file with the Network Viewer function, you can have the programmed display with the projector .

Procedure of making program

- 1 To launch the Program Editor, click "Network Viewer 3 (Program Editor)" menu from "Start" - "All Programs" - "Network Viewer & Capture 3" menu.
- 2 Click **Connect** button.
- 3 If the connection setting window appears, enter the each item and then click **OK** button.

The setting window disappears and then the programs are listed on the window if there are program files at the login directory in the connected FTP server.

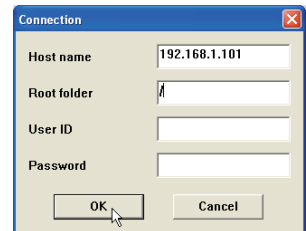
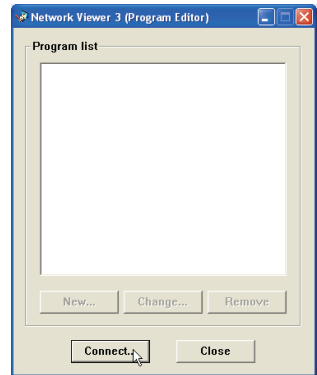

Item	Description
Host name.....	Enter the FTP server name or IP address
Root Folder	Specify the root directory of the FTP server. Normally use "/".
User ID	Enter your login account of the FTP sever or use blank when you login as anonymous account for the FTP server
Password.....	Enter your password (PIN code) or use blank when you login as anonymous account.

IMPORTANT

It is required to set the write permission mode for the login directory of the FTP server. If only the read only mode, you will have an error when you register a new program.

4 Click **New** button.

5 Enter a program name and click **Add** button.

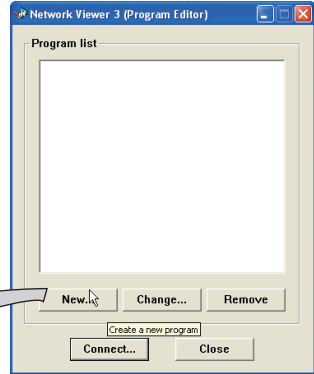
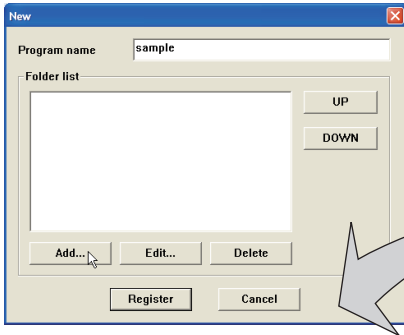

Change : Changes the contents of the program file.

Remove : Removes the program from the list.

6 The folder selection window appears and select a folder in which the JPEG data are stored and then click **Add** button to register into the folder lists.

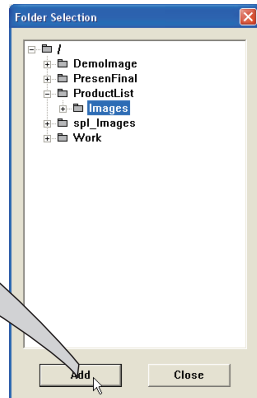
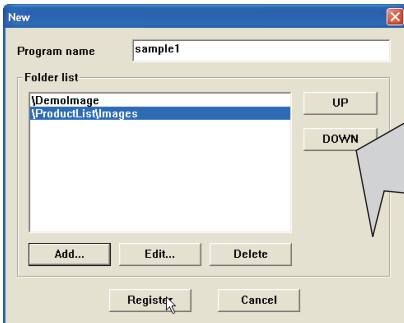

AddDisplays the folder selection window.

DeleteDeletes the folder path from the folder list.

UPMoves up the selected folder path.

DOWNMoves down the selected folder path.

Edit.....Used to set up the display order or display time of the image individually. For further information see item "Setting up the display order and time of the images" on the next page.

☞ The order of the display is listed in the folder list window. To change the order of the display, change the list order of the folder list by using **UP** or **DOWN** button.

☞ The programs are stored into the "DispParam" folder at the login root directory and this "DispParam" folder is made by software automatically.

7 Click **Register** button to register the folder list into the program.

8 Click **Close** button to quit the Program Editor.

Setting up the display order and time of the images

In the default setting, the display order of the images is ASCII code order of the file name. To change the display order or to set up the display time, take the following procedure.

Display the folder list window in step 6 of the previous page.

- 1 Select a folder list contains images to change.
- 2 Click **Edit** button. The images in the selected folder are displayed with the file name on the index window.

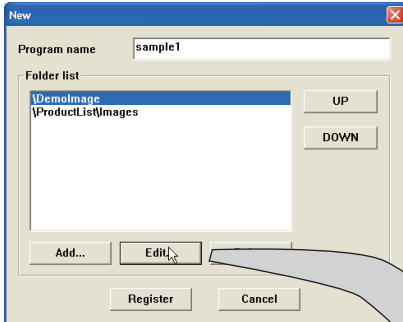

When selecting "Image" from "View" menu, the thumbnail of the image will be displayed (default setting). When selecting "Icon", the icon image will be displayed.

- ☞ It takes a time to display thumbnails.
- ☞ The number in front of the file name indicates the display order of the image.

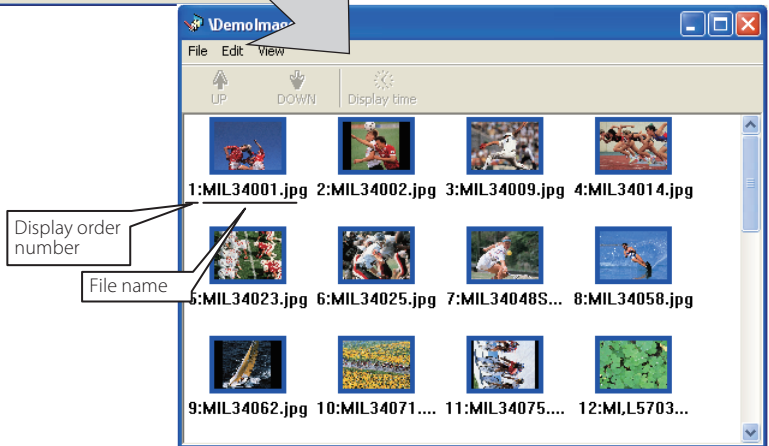

Menu	Sub menu	Description
File	Exit.....	Closes index window
Edit	UP.....	Steps up the display order of the selected images
	DOWN.....	Steps down the display order of the selected images
	Display time.....	Sets up the display time of the selected images
View	Image.....	Displays thumbnail of the images
	Icon.....	Displays images as the fixed icons
	Update.....	Updates images information on the index window

- 3 To change the display order, select*1 files and then click **UP** or **DOWN** button on the menu bar to move them onto your desired place, or select files and then drag and drop them onto your desired place with mouse.
- 4 To change the display time*2, select*1 files and then click **Display time** button on the menu bar to display the Display time setting window. Check "Display time" check box and set display time. To cancel the display time, un-check the "Display time" check box.

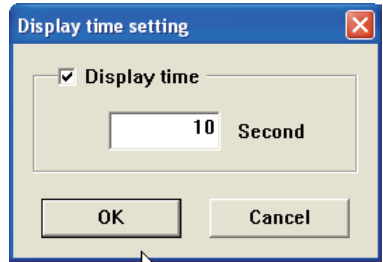
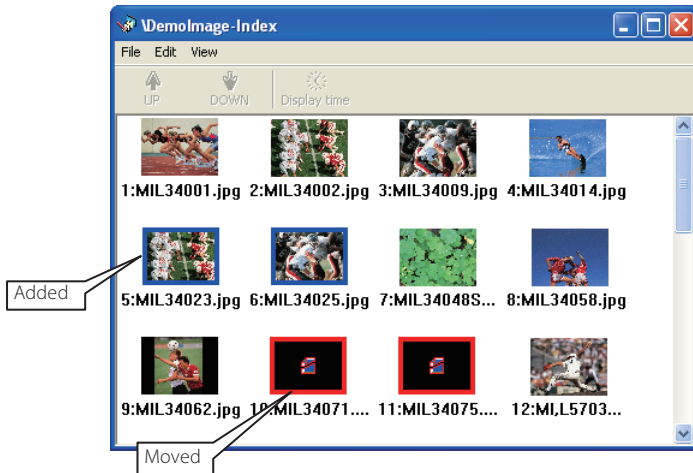

Image frame on the index window

Image frame on the index window has 3 kinds of display modes as follows.

- No frame : Shows that the image in the folder is unchanged
- Blue frame : Shows that image is added into the folder newly
- Red frame : Shows that image is deleted from the folder



*1 Enable to select multiple files at once by using "Shift" or "Control" key, or with mouse cursor.

*2 Enable to set up 3 to 240 seconds for display time.

Example of the created program selection

Use the web browser to access to the control page of the projector. Click **Viewer** of the **Network** menu on the web page, then connect to the FTP server and select the program name which was made at previous section. The projector starts displaying the images along the program. For further information, please see "Using the Network Viewer function" (p.98).

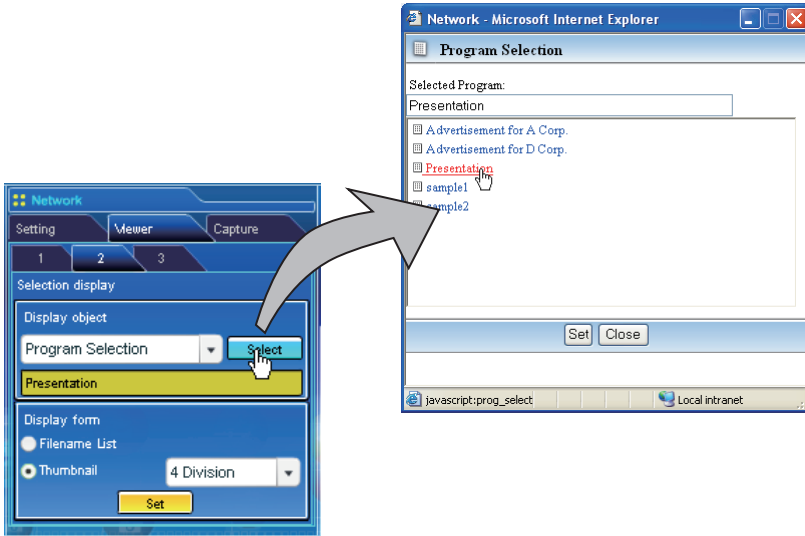

☞ This function is not available in the light mode.

The limitation of the Program file

There are several limitations for the program file as follows;

- * Number of programs in a root folder is less than 1000.
- * Number of folders in a program is less than 100.
- * Total characters of folder name is less than 255.
- * Total characters of program file name is less than 63.
- * Do not make a program name started with ".".
- * Do not make a program name contained with following characters:
 $\backslash / : ; * ? " < > |$
- * The program name started with " "(space) is registered with removing the space.

Using the Network Viewer function

The Network Viewer is a function to acquire the JPEG image data from the file servers placed in the network and project them on the screen. The projected image data are specified with the folder unit. You can set the display period and repeating times, and also you can register those folders as the program. ***The network viewer function cannot be used when using the network capture function.**

Condition to use the Network Viewer function:

- * Enables to use the FTP service with Windows 2000 Professional or XP Professional.
- * User must have a full-access account to the FTP server or the FTP server allows anyone to use with "Anonymous" account which also has a full-access mode.
- * The allowed number of simultaneous access from the same IP address is more than 20.

To use this function, it is necessary to disable "pop-up block" function of the web browser.

[1] Control by the web browser

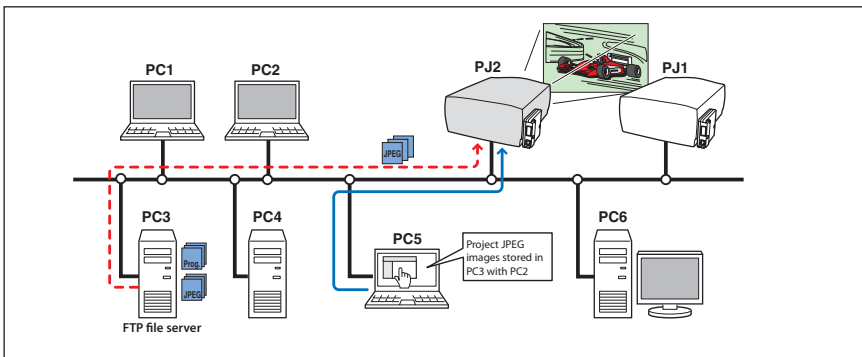

Select input mode to "Network" previously.

1 Access to the control page on the projector by using the web browser.

From the main menu, click **Network - Viewer** to display the setting page.

2 Setup the setting page [1] of the Visual display.

Item	Description
Host name.....	Enter the host name or IP address of FTP server, yourftp.server etc.
Folder Path	Use "/"(root directory) in normal, or enter the directory name follow the "/" as shown in the below example if you have a specified directory in the server. /data/
User ID*1.....	Enter your login account of the FTP server
Password*1	Enter your password of the FTP server
Option*1	Set "Display ON" when you display the acquired preview images on the web browser.



3 Setup the setting page [2] of the Selection Display.

Click **Select** after selecting from the pull-down menu "Folder Selection" or "Program Selection" for the Display object. The list window appears and select a program or folder and then click **Set** on the window.

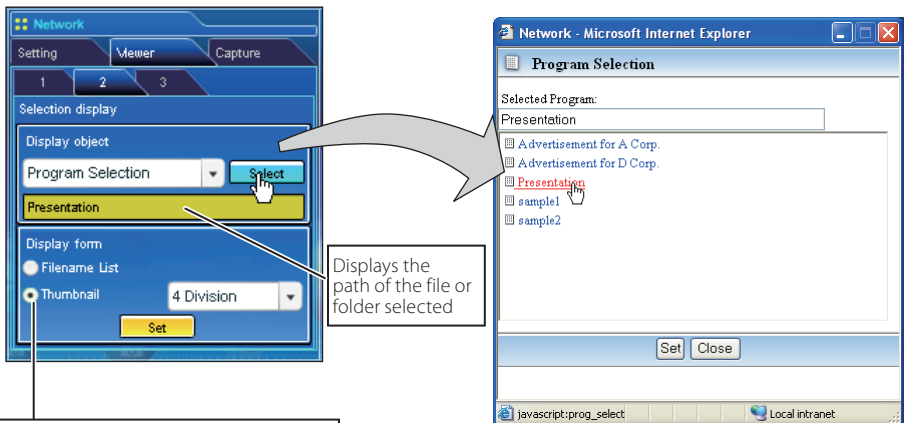

Selects the display type either the listed with file name or listed with thumbnail. The thumbnail can be selected "4 division", "6 division" or "9 division".

- ☞ This function is not available in the light mode.
- ☞ See item "Creating a Program file [Program Editor]" (p.93) for about program.

*1 IMPORTANT NOTICE

Please note that if you use the FTP server with personal account except anonymous account, the user ID and password may be displayed on the browser depending on the version of the browser. We recommend that this function should be used with the anonymous account usually.

When clicking **Set**, the file list or preview list of the selected folder or program is displayed on the window.

Decides a image to start auto display with radio button

Selects a page

The original image is displayed on another window by clicking on the preview image or file name

Button	Operation
<<.....	Steps down the startup image in the auto display function
>>.....	Steps up the startup image in the auto display function
List	Switches to the List mode
Thumbnail.....	Switches to the thumbnail mode
Close.....	Close the window

- ☞ This function is not available in the light mode.
- ☞ The preview image will not appear when the option is set "Display OFF".(p.99)

- ☞ Up to 1000 images can be displayed.
- ☞ When selecting "folder selection", it displays images placed at the first directory in the selected folder.
- ☞ The display order of the images is according to the ASCII character order when selecting "folder selection", or is specified by the Program Editor when selecting "program selection".

4 Auto Display setting and control page [3]

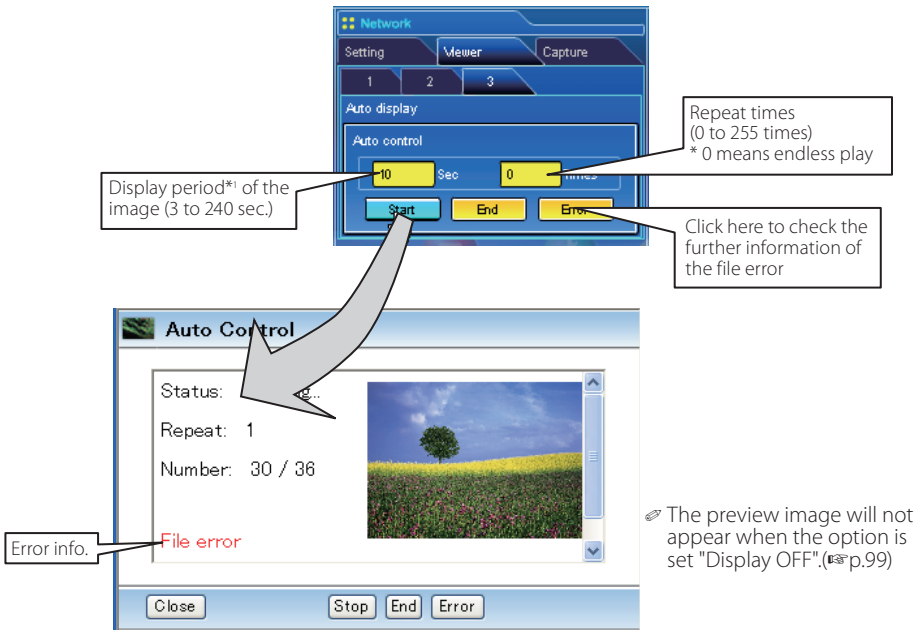

1. Click **Start** button to start the auto-display. The image in the selected folder or program is displayed on the projector's screen. The web browser opens another window and displays the preview images on the Auto Control window sequentially.
2. Click **Stop** button to stop the auto-display.
 - Restart the auto-display, click **Restart** button.
 - * During the auto-display stops, it enables you to display the images manually by using [**<<**] or [**>>**] button.
3. Click **End** button to end the auto-display.
 - When pressing the **Error** button, the further information of the file error is displayed.

For further error information, refer to the next page.

*1 When selecting the program file for auto-display, the display time of each image gives preference to the setting specified by the program file over the setting specified by the auto-display function above. The images not set the display time is according to the display time specified by the auto-display function above.

☞ The display period is greatly affected by the network environment or the operation of multi control, so it may not display the image as the specified display period.

☞ The switching is not the same timing between the images on the screen and on the web browser.

Error information

Error type	Description
File Error	It is displayed when the network unit cannot acquire the correct file images from the FTP server, or when the master projector is turned off during the multi-control. Click Error button to check the details.
Connection Error	It may be displayed when the slave projector is using the Network Viewer or Capture function during the multi-control. Check which projector has an error , see item "Multi Control/Conf. & Change" (☞ p.64-65).

☞ When the file error is occurred during the auto-display, you may have the alert e-mail message. For further information, please see item "3 Option selection for sending alert mail" (☞ p.39).

[2] Control by the projector

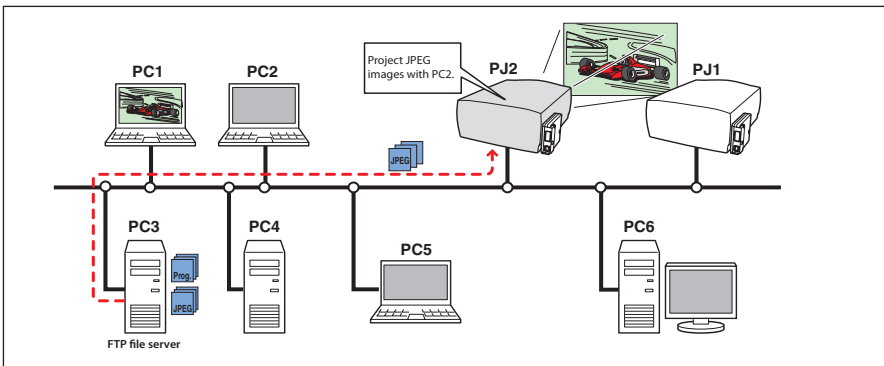

Select input mode to "Network" previously.

I Select "Network Viewer" icon from "Network" menu. Press **SELECT** button on the projector twice to display the network viewer setting pallet.

The screenshot shows the 'Network viewer' control interface. At the top, it says 'Network viewer' and 'XGA 1'. Below this is a 'On' button. A vertical menu on the left contains several icons, with the 'Network viewer' icon highlighted. The main control area includes:

- A 'Network viewer' title bar.
- A checked 'Auto' mode selector with a red arrow pointing left.
- A '5 Sec' display time setting with left and right arrow buttons.
- An '∞ On' repeat times setting with left and right arrow buttons.
- A 'Manual' mode selector.
- 'Connect' and 'Disconnect' buttons.
- A 'Repeat times' label pointing to the '0 Times' setting.
- A 'Display time' label pointing to the '5 Sec' setting.
- A callout box pointing to the 'On' mode selector with the text 'Set On if the endless playback'.

- 2 Select "Auto" or "Manual" and then press **SELECT** button. When selecting "Auto", Set display time and repeat times
- 3 Select "Connect" and then press **SELECT** button to start displaying. The images in the FTP server are displayed on the screen.
 - ☞ It enables you to browse the images by using the control buttons (▼▲) on the remote control or on the projector.
- 4 To end displaying, select "Disconnect" and then press **SELECT** button.

Item	Description
Auto	Auto display mode. Specifies display periods and repeating times
Sec.	Display period of the image (3 to 240 sec.)
∞	Set "On" if the endless playback mode
Times ...	repeat times (255 times maximum)
Manual	Manual display mode. Controls image display (browsing image backward or forward) manually.

- ☞ In the automatic displaying mode [Auto], when the left-click on the remote control is pressed, projector stops automatic displaying and sets into the manual displaying mode. When pressing the right-click, it starts automatic displaying again.
- ☞ The image data used for this function are the program or folder that the Network Viewer function used last time. The projector cannot specify particular images or file servers itself.
- ☞ The display period is greatly affected by the network environment or the operation of multi control, so it may not display the image as the specified display period.

7

Chapter 7 *Appendix*

Connection examples

Web browser setting

Technical data

Q & A

Examples of connection

Peer-To-Peer connection

Connecting the projector (PJ01) to the control computer (PC05) directly.

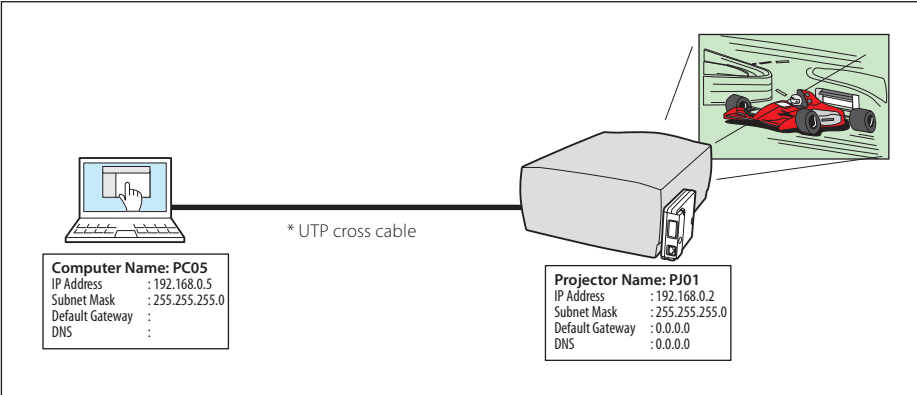

Connecting the projector (PJ01) to the control computer (PC05) via the hub.

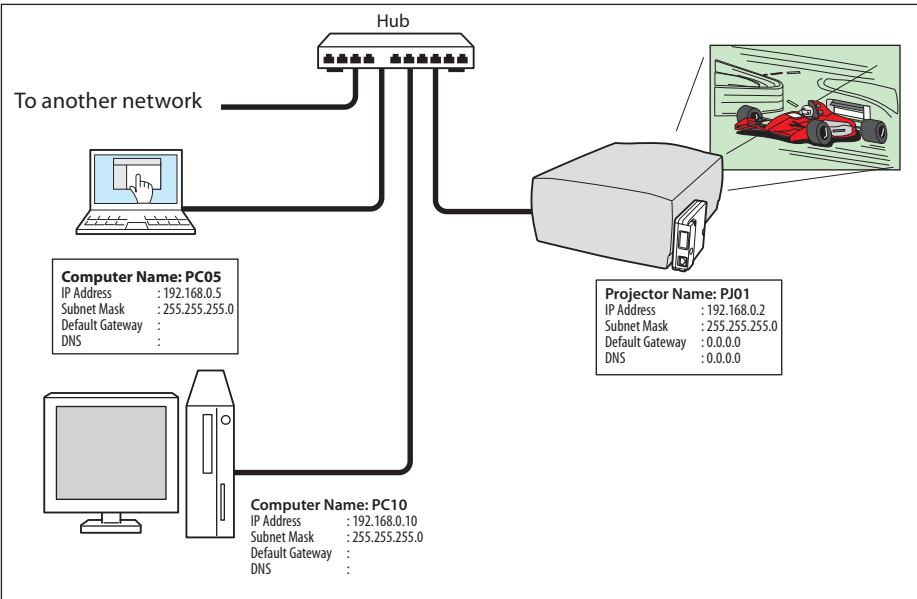

When the projector is connected to the computer directly without hub, the UTP cross cable should be used.

The gateway (Router) installed in the network

Connecting the projector (PJ01) to the control computer (PC05) via the gateway.

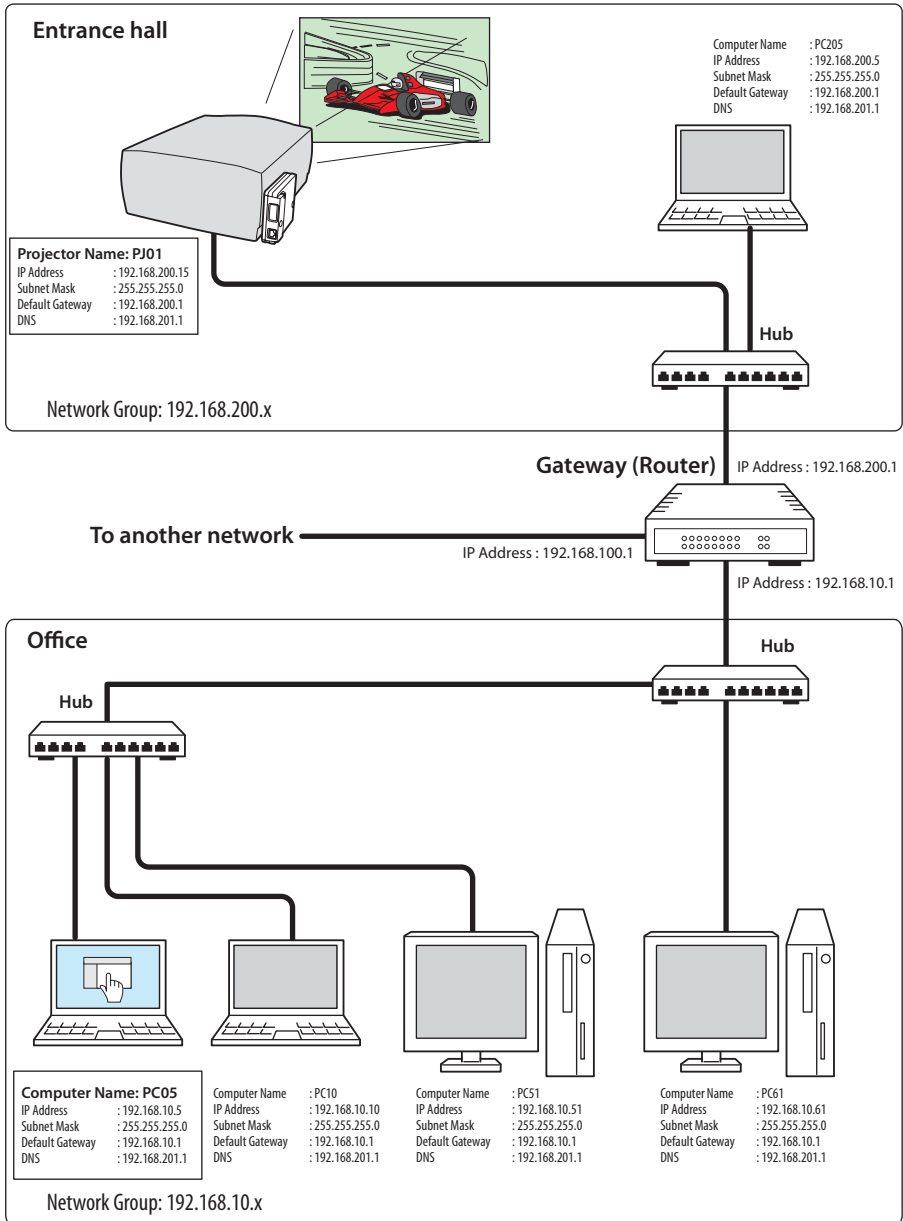

Web browser setting

This product is designed to enable the projector to be set up and controlled from an Internet web browser. Depending on the preference settings of the web browser, some control functions may not be available. Please make sure that the following functions are set up properly in the web browser.

Active Script/JavaScript enable

There are some control items used with the JavaScript function in the setting pages. If the web browser is set not to use this JavaScript function, it may not control the projector properly. In this case, the following warning message will be displayed on the top of the page. To enable the JavaScript, please see further instructions on the next page.



Flash Player enable

The setting page of this product contains the Flash contents. To display the setting page, the Adobe Flash Player version 6 or later is required to be installed on your computer. For further product information, see the Adobe homepage. (<http://www.adobe.com>). Even if your computer provides the Adobe Flash Player and the setting page does not appear on the web browser, check that Flash Player Plug-In(Shockwave Flash) is installed and set up correctly. please see further instructions on the next page and it is depending on the web browser.

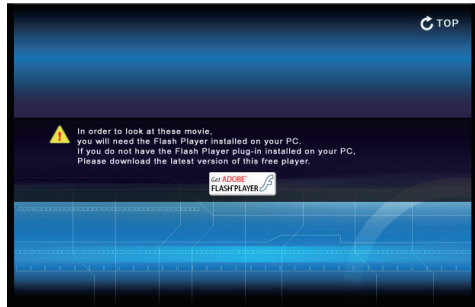

Proxy setting

In some cases, your web browser is set up to use the proxy server for the internet or intranet connection. In this case, when you install this product into the local network, you should set up the proxy setting of web browser preference correctly. Especially when connecting the projector and computer with a UTP cross cable directly, or when the network does not provide the proxy server, make sure that "not use proxy server" is set up in your web browser preference. Please see item "Examples: OS/Browsers" in the next page for further setting up procedure.

 There are various ways to change your browser preferences depending on the version or applications. Please see the setting instructions on next page for example and also refer to on-line help of your web browser.

Examples: OS/Browsers

Windows XP Professional

Internet Explorer v.6.0

ActiveScript setting

Select **Internet Options** from **Tools** menu on the web browser and then select **Security** tab and click **Customize Level...** button. On the security setting window, scroll down and find the **Scripting** item, make sure that "Enable" is selected in item **Active Scripting**.

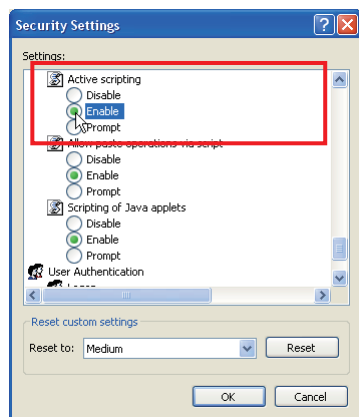
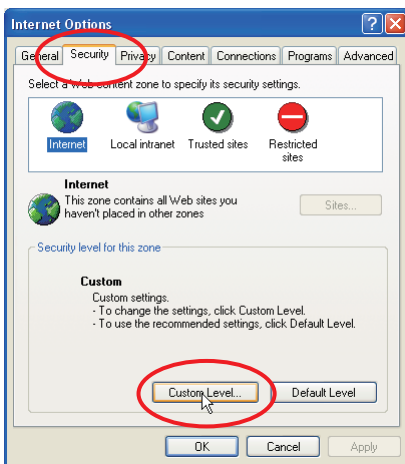

Flash Player enable

ActiveX controls and plug-ins setting

Select **Internet Options** from **Tools** menu on the web browser and then select **Security** tab and click **Customize Level...** button. On the security setting window, scroll down and find the **ActiveX controls and Plug-ins** item, make sure that "Enable" is selected in item **Run ActiveX controls and plug-ins**.

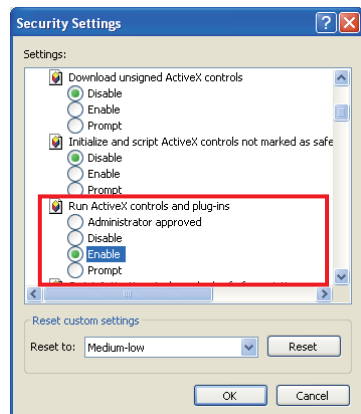

Flash Player Add-on setting

Select **Manage Add-ons...** from **Tools** menu on the web browser. Select "Add-ons currently located in Internet Explorer" from **Show** pull-down menu. Make sure that the "Shockwave Flash Object" is listed under the item "Enabled".

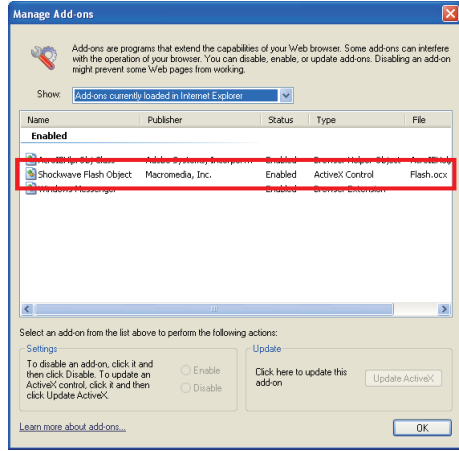

Proxy setting

Select **Internet Options** from **Tools** menu on the web browser and then select **Connection** tab and click **LAN Settings** button. Properly set up your web browser's the proxy server settings according to the local area network environment to which the projector is connected.

- Using proxy server

To use an external internet connection from the local area network, check the item **Use a proxy server** and enter the proxy server address and port correctly in the proxy settings window. For further instruction please consult your network administrator.

- Not using proxy server

Uncheck the item **Use a proxy server**.

If you connect the projector to the computer directly with UTP cross cable, this must be unchecked.

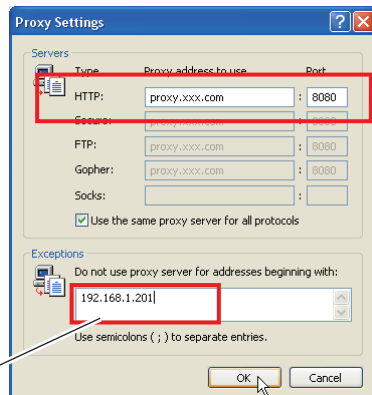
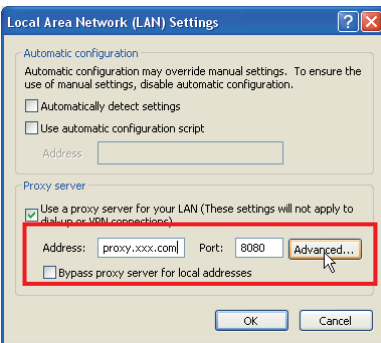

To designate proxy settings that will not use the proxy server when accessing the projector installed in the local area network, enter the IP address or domain name here.

Netscape Navigator v.7.0

JavaScript Setting

Select **Preference** from **Edit** menu on the web browser and then select the item **Advanced/Scripts & Plugins** in the **Category** column. Make sure that the **Enable JavaScript for Navigator** is checked.

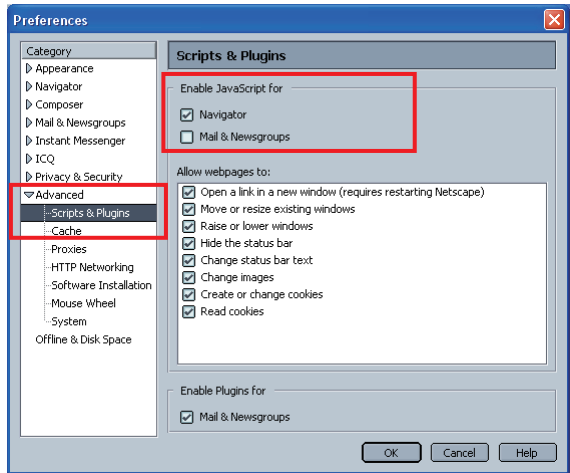

Flash Player enable

Flash Player Plug-in setting

Select **About:Plug-ins** from **Help** menu on the web browser. The plug-ins software provided on the browser are listed on the page. Check that the **Flash Player Plug-in (Shockwave Flash)** is installed and set up correctly as the below.

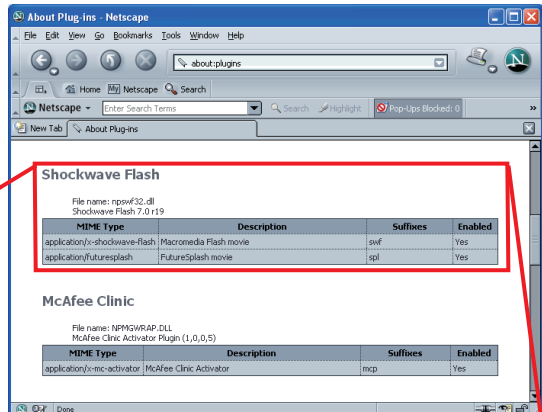

Shockwave Flash

File name: npswf32.dll
Shockwave Flash 7.0 r19

MIME Type	Description	Suffixes	Enabled
application/x-shockwave-flash	Macromedia Flash movie	swf	Yes
application/futuresplash	FutureSplash movie	spl	Yes

Proxy setting

Select **Preference** from **Edit** menu on the web browser and then select the item **Advanced/Proxies** in the **Category** column. Properly set up your web browser's the proxy server settings according to the local area network environment to which the projector is connected.

- Using proxy server

When you use an external internet connection from the local area network, select the item **Manual proxy configuration**. Enter the proxy server address and port number correctly on **HTTP Proxy** item. For further instruction please consult your network administrator.

- Not using proxy server

Select the item **Direct connection to the Internet** in the proxy setting window. If you connect the projector to the computer directly with UTP cross cable, this must be selected.

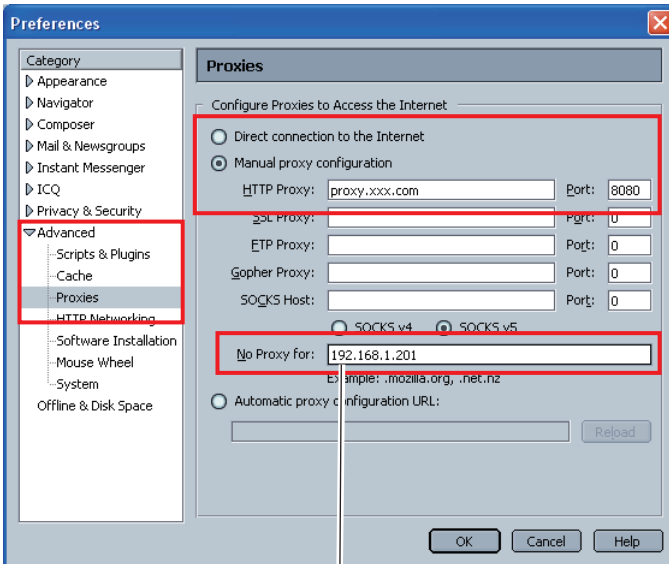

To designate proxy settings that will not use the proxy server when accessing the projector installed in the local area network, enter the IP address or domain name here.

Product specification

Type.....	Network unit	
LAN interface.....	Applicant regulation	IEEE802.3 (10Base-T) IEEE802.3u (100Base-TX)
	Data transfer speed	10Mbps/100Mbps
	Data transfer mode	Half duplex/Full Duplex
	Terminal	8-pin modular (RJ-45)
Network protocol.....	TCP/IP specification	TCP/IP
Power source.....	Supplied from the projector	
Power consumption.....	3.0 watts	
Dimensions (W x H x D).....	5.20" x 4.13" x 1.32" (132 x 105 x 33.6 x mm)	
Weight.....	0.57 lbs (258 g)	
Built-in battery.....	Lithium battery, Type CR2032, 3.0V	
Operating temperature.....	41°F ~ 95 °F (5°C ~ 35 °C)	
Storage temperature.....	14°F ~ 140°F (-10°C ~ 60°C)	

* The specifications are subject to change without notice.

Port specification

LAN port specification

8-pin modular connector (RJ-45)

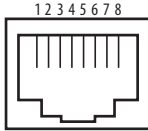

Pin No.	Signal	Function
1	TX+	Transfer data (+)
2	TX-	Transfer data (-)
3	RD+	Receive data (+)
4	(not used)	
5	(not used)	
6	RD-	Receive data (-)
7	(not used)	
8	(not used)	

Q&A

Installation/Access

Q *Why doesn't the setting page appear in my web browser?*

A Following causes are possible. Please check them.

1. The projector does not connect to the network.
Check LED indicators status (☞ p.17).
 - Check the connection of LAN cable if the LINK indicator does not illuminate red.
 - Check the network configuration of the projector if ACT indicator does not illuminate green.
2. Function "Network" in the projector is not set to "ON".
Set up by using the projector's on-screen menu (☞ p.20).
3. Wrong network configuration of the projector
Check the network configuration of the projector by using the projector's on-screen menu (☞ p.20).
4. Wrong network configuration of the computer.
Check the network configuration of the computer.
5. The network unit is used with the default setting (☞ p.20).
6. The proxy setting of the web browser is not set correctly (☞ p.116).
7. The computer does not provide TCP/IP protocol.

Q *No setting page in my web browser? Is the problem in the network or in the projector? I would like to find out the problem whether it is in the network or in the projector*

A Check it by the following steps

1. Disconnect the projector from the network and connect the projector and computer with the UTP cross cable directly.
2. Change network configuration of the computer and projector as shown in the example below.

(Projector setting)	(Computer setting)
IP Address : 192.168.0.2	IP Address : 192.168.0.5
Subnet Mask : 255.255.255.0	Subnet Mask : 255.255.255.0
Default gateway : 0.0.0.0	Default gateway : (blank)
DNS : 0.0.0.0	DNS : (blank)

3. Enter the projector's IP address [192.168.0.2] at "Address" column on the Web browser. [Note] Make sure that the proxy setting of your web browser is set "Not use a proxy server" (☞ p.116).
4. If the login page appears, this product is operating properly. The problems may be in the network configuration of the computer or in the network. Please try to set up the network by following item "Network configuration" (☞ p.20). If the login page does not appear, please check for proper mounting of this product onto the projector by referring to chapter "Installation and Network configuration" (☞ p.18-19).

Q *How can I restrict access from the computer.*

- A**
1. Please use the password authentication function on the login page (☞ p.30).
 2. Please use the IP filtering function provided with the gateway (router) to restrict the accessing from the computer. For further information please consult your network administrator.

Q *Can I access the projector installed on the company's local area network from a remote location?*

- A** There are some ways to access to the projector in the LAN, but you must consult your network administrator for security reason.
- ☛ Use of modem
(Connect to the company's network from your home or some other places by using modem.)
 - ☛ Use of private line
(Connect to the company's network from the branch office or maintenance office by using private line.)
 - ☛ Use of internet
(Connect to the company's network from your home, branch office or some other places by using the internet.)

Q *We use the DHCP/BOOTP server to assign the IP address. Is it possible to use the network unit in this network environment?*

- A** Possible. As the network unit does not support the DHCP/BOOTP server, the fixed IP address must be configured manually. Please consult your network administrator (☞ p.24).

Q *How can I install several projectors equipped with the network unit?*

A Install and configure network one by one to avoid the IP address collision each other (☞ p.24).

To configure the IP address please see item "Network configuration" (☞ p.20).

Q *How many projectors can I control with multi-control function?*

A It has been designed to control up to 100 sets but it depends on the network environment.

Password/Login

Q *What should I do when I forget the password?*

A Select "Network PIN code" sub menu from "Network" menu on the projector. For further information, please see item "Network PIN code setting" (☞ p. 22).

Q *Can I register the setting page as a web browser "Favorites" or "Bookmarks"?*

A Please add "Login" page to your "Favorites" or "Bookmarks". Do not add the specified setting page because it will not be able to perform the password authentication correctly.

Operation

Q *Why can't I change the controls in the setting page with web browser?*

A Please make sure the projector is turned on. If it is in the standby mode, the setting is not effective to the projector. To control the projector with a web browser, the projector must be in the powered-on condition. Also, projectors registered for multi-control cannot have any controls changed if they are in standby mode. But timer and clock settings are always effective, even for projectors in standby mode.

Q *Why does it sometimes take a lot of time to complete the page display?*

A The display speed of the page depends on the network environment in which both the projector and computer are placed. It may take much time to complete the page display if network traffic is heavy. Please consult your network administrator. You can select the Light mode for displaying pages quickly (☞ p.30).

Q *I use many of the projectors in the network. How can I use names of the projectors to recognize each projector instead of IP addresses?*

A You can manage the projectors with nicknames instead of the IP address. Please see item "Multi-control" for further information (☞ p.62).
By registering the projector name and IP address with the DNS server, it can be accessed with the nickname from the any computer referred to the DNS server. Please consult your network administrator.

Q *How many numbers of the E-mail address can I register in the E-mail setting page.*

A You can register up to 10 addresses.

Q *Why am I not receiving E-mail alert messages?*

A Make sure that the registered E-mail address and SMTP server address are correct. If the SMTP server is located in your LAN (Local Area network), the address should be set to the SMTP server in your LAN. The SMTP server located outside of your LAN may not be available for security reason. For further information please contact your network administrator (☎ p.38).
It may be required for the authentication depending on the SMTP server. This product does not support this kind of SMTP server.

Q *Can I update the firmware of the network unit.*

A It is possible to update the firmware through the network. It is required to have a special tool for the updating. For further information please consult your local dealer. The version number of the firmware is indicated on the lower part of the "Initial Setting" page.

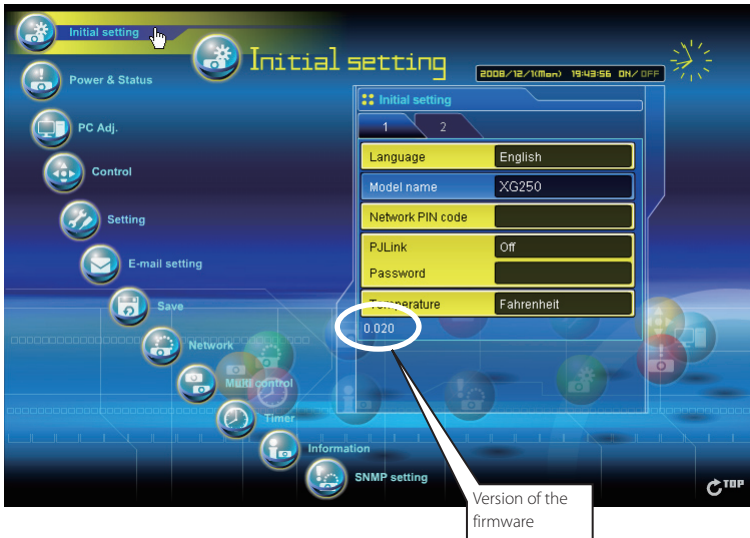

Q *What are the rules for IP address assignment?*

A If the network is constructed with TCP/IP protocol, a unique IP address is required for each piece of network equipment. The following are basic rules of the assignment.

Rule1

Do not configure the same IP address to the network equipment in the same network group. Each piece of equipment must be assigned a unique IP address.

If the IP address is set [192.168.x.x], the Subnet Mask should be set [255.255.255.0] for example.

Rule2

The start address [xxx.xxx.xxx.0] and the last address [xxx.xxx.xxx.255] of the IP address must not be assigned to any other equipment. These address numbers are reserved.

Rule3

The IP address must correlate to a network number. If network numbers are different between the equipment, they cannot establish communications each other. In this case, the router is placed in the networks to make the routing.

Q *What is the MAC address assigned to the network unit?*

A The MAC address is indicated on the case back as the below.

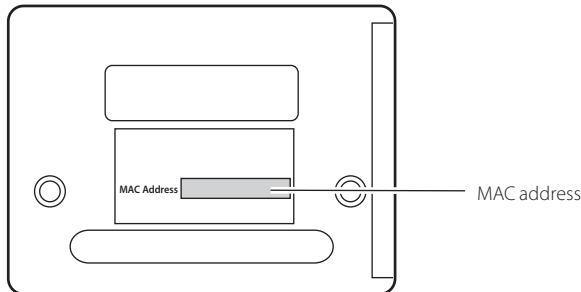

Network capture

Q *Why doesn't the computer screen appear on the projected screen?*

- A**
1. Make sure that the input mode of the projector is "Network".
 2. Make sure that the Network Capture icon on the task bar of the computer is active (☞ p.70).
 3. Check the parameter set up (☞ p.71).
Make sure that the numbers of the capture port is the same as the projector's port number. The default port number is 9000. If the alert message "Invalid Port No." appears, your computer may be using this port number already. In this case, use another port number.
 4. Check the IP address of the computer is registered to the network unit correctly (☞ p. 72).
 5. Make sure that your computer is not using the firewall function. The network unit may not be able to use the port due to this firewall function. In this case, please turn off this function temporarily. There are also some port limitations on the network equipment such as router. Please consult your network administrator.

Network Viewer

Q *Images from the file server don't appear on the screen?*

- A**
1. Make sure that the input mode of the projector is "Network".
 2. Check the account setting of the FTP server (☞ p.99).
 3. The files in the FTP server must be optimized JPEG and converted by using the File Converter 1 or 2. Please check data format. (☞ p.89)
 4. There are several limitations for image file name and program name. Please check file names and program names (☞ p.97).
 5. Make sure that your computer is not using the firewall function. The network unit may not be able to use the port due to this firewall function. In this case, please turn off this function temporarily. There are also some port limitations on the network equipment such as router. Please consult your network administrator.

Q *I cannot make a new program file.*

- A**
1. Check your account of the FTP server. You must have a mode "Write enable" for its account.(☞ p.93)

File Converter 1

Q *What kind of image formats can I convert?*

A The File Converter 1 enables to convert to the JPEG format from the following image format.

Bitmap format (.bmp)

JPEG format (.jpeg .jpg)

Microsoft power point format (.ppt)

File Converter 2

Q *Sometime I have the white frame images converted by the File Converter 2?*

A It may have images with white frame due to the paper margin of the print driver depending on the image data.

EIKI

U.S.A.

EIKI International, Inc.
30251 Esperanza
Rancho Santa Margarita
CA 92688-2132
U.S.A.
Tel : 800-242-3454 (949)-457-0200
Fax : 800-457-3454 (949)-457-7878
E-Mail : usa@eiki.com

Deutschland & Österreich

EIKI Deutschland GmbH
Am Frauwald 12
65510 Idstein
Deutschland
Tel : 06126-9371-0
Fax : 06126-9371-14
E-Mail : info@eiki.de

China

EIKI (Shanghai) Co., Ltd.
1. Dapu Road,
Golden Magnolia Plaza
#2109 Shanghai,
200023 China
Tel : 86-21-5396-0088
Fax : 86-21-5396-0318
E-mail : info@eiki-china.com

Canada

EIKI CANADA - Eiki International, Inc.
P.O. Box 156, 310 First St. - Unit 2,
Midland, ON, L4R 4K8, Canada
Tel : 800-563-3454 (705)-527-4084
Fax : 800-567-4069 (705)-527-4087
E-Mail : canada@eiki.com

Eastern Europe

EIKI CZECH SPOL. s.r.o.
Nad Cementárnou 1163/4a
Paraha 4, Podolí
147 00
Czech Republic
Tel : +42 02 4141 0928
+42 02 4140 3095
Fax: +42 02 4140 9435
E-Mail : easterneurope@eiki.de

South East Asia

EIKI Industrial (M) Sdn Bhd
No. 3A-2C, 4th Floor, Jalan PJU 8/3A,
Perdana Business Centre,
Bandar Damansara Perdana,
47820 Petaling Jaya, Selangor
Malaysia
Tel : +603-7722-4362
Fax : +603-7722-4392
E-Mail : sales@eiki.my

Japan & Worldwide

EIKI Industrial Company Limited.
4-12 Banzai-Cho, Kita-Ku, Osaka,
530-0028 Japan
Tel : +81-6-6311-9479
Fax : +81-6-6311-8486

WorldWide Website <http://www.eiki.com>