

EIKI

Edge blending adjustment manual

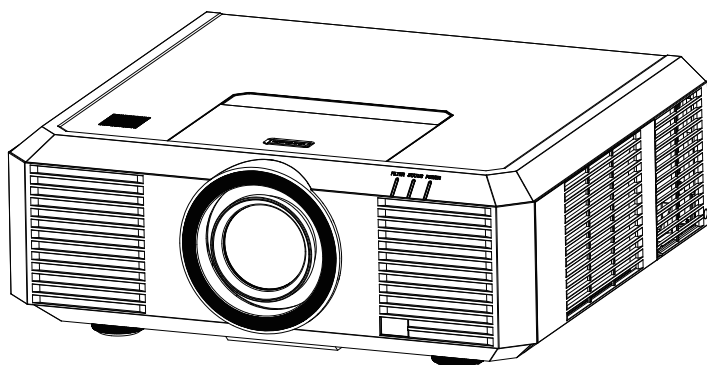

Edge Blending function

Edge Blending function could project bigger and brighter with high resolution pictures via multi projector. The Edge Blending software could adjust the color and the effect of the overlay edge.

Equipment:

2 or more projector with same resolution, Video duplicator, RS232 series cable.

Connection:

- (1)Setting the projectors with the same level from ground and the same projection distance from screen.
- (2)Project the image through the video duplicator to each projectcotr.
- (3)Connect the computer and projectors via RS232 cable.

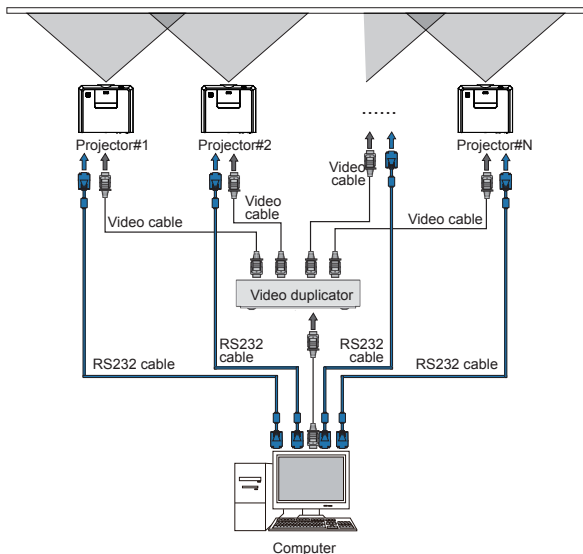

Setting:

- (1)Setting the projected image as the same dimension by each projector.
- (2)Press Menu button on the remote controller or control panel to pop up the OSD.
- (3)Press ▲▼ button to select "Display"
- (4)Press ▲▼ button to select "Aspect"
- (5)Press ▲▼ button to select "Advanced" and press OK to ready for Edge Blending function.

Adjustment:

The color and effect of the overlay edge can be adjusted with the Edge Blending software.

The Edge Blending Software and its manual can be downloaded from EIKI website.

URL: <http://www.eiki.com>

✓ Note:

- Edge Blending function can only effected with the same resolution projectors.
- Edge Blending function can apply via HDMI, VGA and RGBHV as input source.
- Setting the same level and position with the same dimension image would make the better effect after edge blending adjustment.

Edge Blending function

Launch the "Edge blending" software to make edge blending operation.

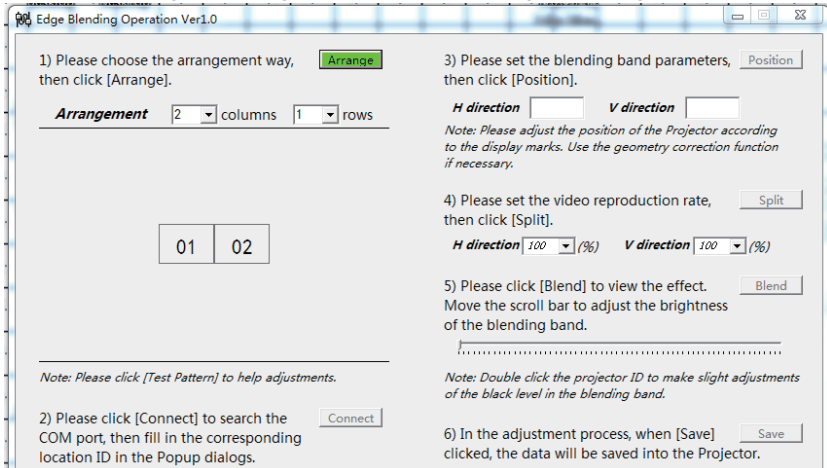

(1) Select the quantity number from "columns" and "rows" from the upper left corner of main page, according to the actual setting. Then click the "Arrange" button to make arrangements.

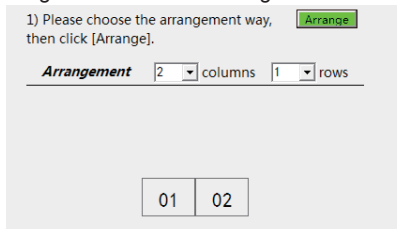

(2) Click the "Connect" button, then set up all ID number about the projector.

Click the "Connect" button, you will see all the valid ID numbers about COM ports (displayed according to the actual connection), then click the "Connect" button again to search the projector connected to the computer. If the connection is not properly, the pop-up message will remind you to click the button once again. Once the connection is well and the software could searched the projector, the "Input Information" dialog box would pop-up.

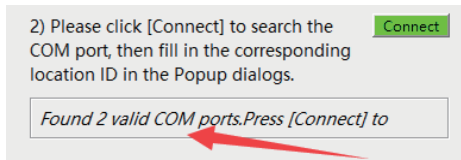

Edge Blending function

Then the projector screen will jump out a red "00" dialogue with white fonts. Next, keyin the corresponding location ID number according to arrangement, and click "Connect" button until all projectors's ID numbers match successfully. Then the "Connected successfully" message will displays.

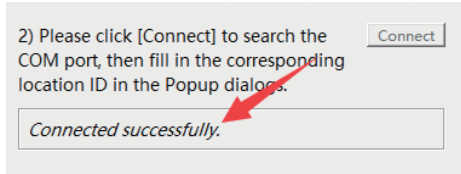

✓ **Note:**

- DO NOT operate the software when the click mouse is busy while performing the operation.

(3)Click the "Test Pattern" button from the lower left corner of the main page, then the "Guide to expand the window" pops up. According to the guidance operation to project the Test Pattern and then return to the computer "Display" window. During that process, you can select different Test Pattern.

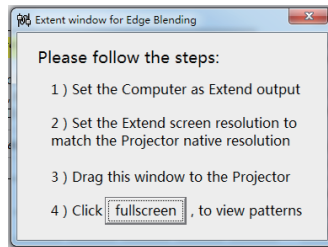
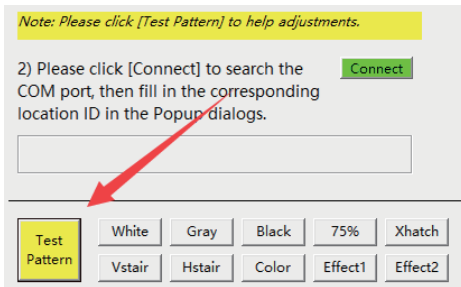

✓ **Note:**

- In the process of Test Pattern, you can double-click the left button of mouse to exit it.

(4)Get into Position operation.

- 1.Click the "Blending Calculation" button of Aided Operationin column in the lower right corner of the main page, then the "Blending Calculation" dialog window will pop up.
- 2.Keyin the Display Aspect Ratio according to the final image.
- 3.Click the "Run" button to calculate and write down the H blending band and the V blending band.
- 4.Close the "Blending Calculation" dialog box.

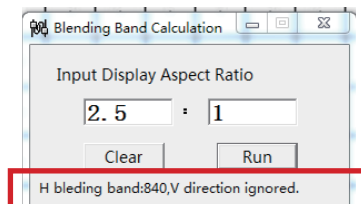
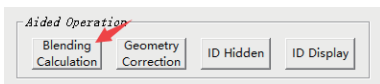

Edge Blending function

5. Key in the blending band value according the result of the calculator (for example, H direction 840 and the V direction 0) in the upper right corner, then click "Position" button.

3) Please set the blending band parameters, then click [Position].

H direction V direction

Note: Please adjust the position of the Projector according to the display marks. Use the geometry correction function if necessary.

6. The projected screen will display rectangular box consisting of green line (left and upper side), purple line (right and lower side) and white rectangle (inner side and outer side)

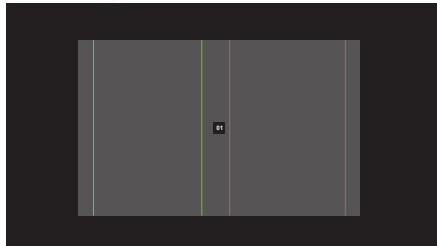

✓ **Note:**

- If the white rectangle has departure from the green and purple line, please check the resolution setting of the projector.
- Please note the figure of position operation might be different via the value of the blending band.

(5) Adjust the edge blending area.

1. Move the projected image to overlap as the figure below:

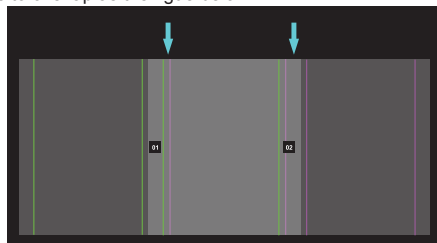

2. Make the two line of the overlap edge combine as one via lens shift function.

3. Click on the "Geometry Correction" button from Aided Operation bar for advance adjustment.

Aided Operation

Edge Blending function

<Usage of the Geometry Correction>

1. Click the "Geometry Correction" button from Aided Operation bar, the adjustment window will pop-up.

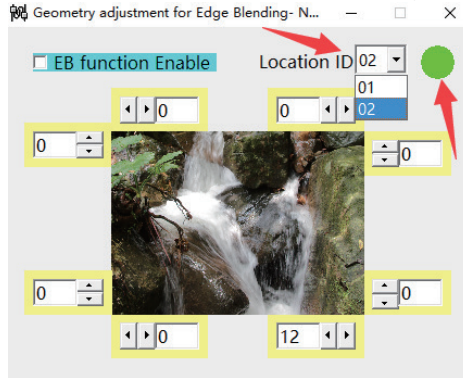

2. Select the projected image you would like to adjust from the Location ID.
3. Adjust the value of the corner to make the edge of overlap area as close as one.
4. Press F5 as preview the effect after adjust the value.
5. Press F2 to save the adjustment.

✓ **Note:**

- When change the value of corner, the point would turn to green from yellow.
- After save the adjustment, the point would turn to yellow.

(6)Get into the splitting operation.

The horizontal and vertical reproduction rates can be selected according to the actual setting. Then click "Split" to projected the image separately.

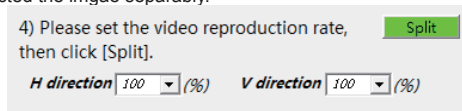

(7)Get into the Edge Blending operation.

Click the "Blend" button to check the edge blending effect of the image

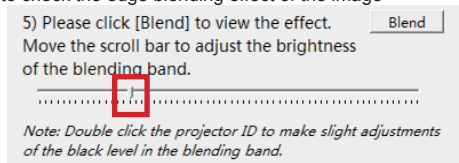

Make adjustments of the brightness of the blending regions by moving the adjust bar. Or you could adjust the black level of the blending regions by the following step:

1. Setting the "Test Pattern" as :Black

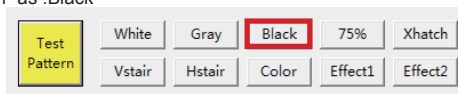

Edge Blending function

2. Click on the screen figure that you want to adjust.

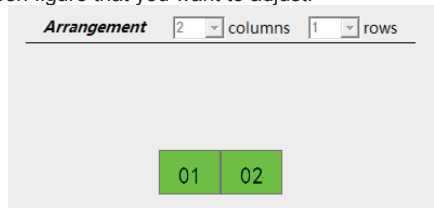

3. The black level adjustment window would pop up.

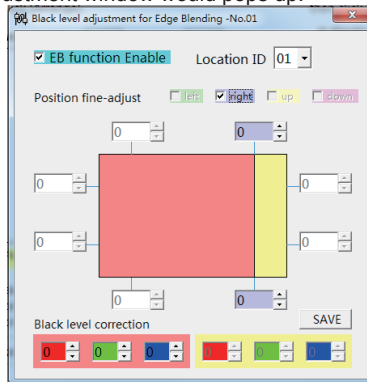

✓ **Note:**

- Red area: adjust the black level correction of the projected image
- Yellow area: the area with edge blending effect
- Purple section: adjustment the width of the blending
- Press F5 as preview the effect after adjust the value.
- Press F2 to save the adjustment.

Edge Blending function

(8) Save / Reset the edge blending setting

<Save>

Press the "Save" button to save the setting of edge blending.

6) In the adjustment process, when [Save] clicked, the data will be saved into the Projector.

The Pop-up window would show the confirmation.

Information

 Data saved successfully.

<Reset>

Press the "Reset" button to remove the setting of edge blending.

7) Click [Reset] will clear the adjusted data and restart the adjustment.

The Pop-up window would shown as below:

Parameters setting

 Press [Yes] if want to arrange location again, otherwise press [No].

Yes Reset all the setting of edge blending.



No..... Restart to setting from "Position" of edge blending.

Cancel.. Get back to the setting main page.

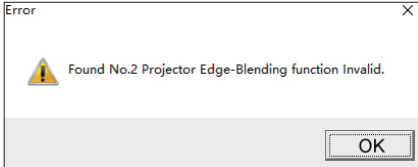
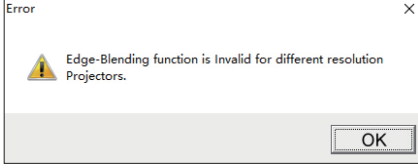
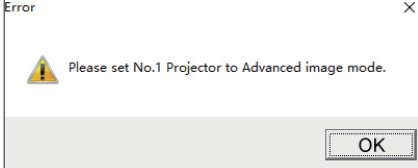
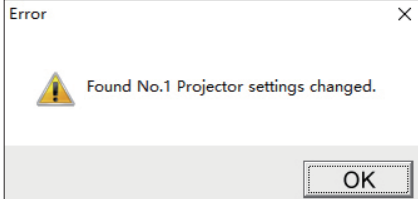
Trouble shooting

1	Question	The screen pops up as " Error " window just as shown in the right image when you execute " Connect " operation during the second step.	
	Analysis	The edge blending function needs configuration permissions where replace the motherboard.	
	Solution	Please contact the after sales specialist.	
2	Question	The screen pops up as " Error " window just as shown in the right image when you execute " Connect " operation during the second step.	
	Analysis	The resolution of projectors for edge blending are different.	
	Solution	Make all projectors are of the same physical resolution for blending	
3	Question	The screen pops up as " Error " window just as shown in the right image when you execute " Connect " operation during the second step.	
	Analysis	Only when the " Screen size " is set to " Advanced ", can the edge blending function are valid.	
	Solution	Set the " Screen size " to " Advanced " in the " Display " of OSD. Please check "Setting" on page 2. .	
4	Question	The screen pops up as " Error " window just as shown in the right image when you execute " Connect " operation during the second step.	
	Analysis	The default setting of Start up logo has been changed.	
	Solution	Set the Start up logo as default.	

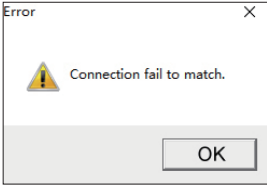
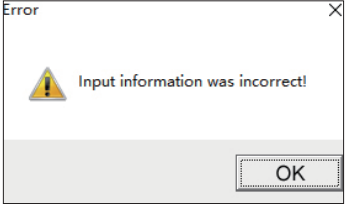
Trouble shooting

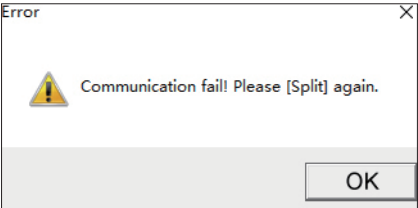
5	Question	The screen pops up as " Error " window just as shown in the right image when you execute " Connect " operation during the second step.	
	Analysis	1) The ID is repeated that make the software cannot connect successfully; 2) Projector is disconnected with the PC.	
	Solution	1) Check whether the ID is repeated or not. If so, please enter the correct ID. 2) Check whether the PC and the projector are connected when the ID is correct.	
6	Question	The ID do not match with the first step configuration permissions where replace the motherboard.	
	Analysis	The edge blending function needs configuration permissions where replace the motherboard.	
	Solution	Input the correct ID number according to the one in the first step.	
7	Question	The screen pops up as " Error " window just as shown in the right image when you execute " Position " operation.	
	Analysis	The communication between the PC and the projector's serial cable is wrong.	
	Solution	Check whether the PC and the projector are connected. If not, please connect them together before you execute Position operation.	
8	Question	The screen pops up as " Error " window just as shown in the right image when you execute " Split " operation.	
	Analysis	The communication between the PC and the projector's serial cable is wrong.	
	Solution	Check whether the PC and the projector are connected. If not, please connect them together before you execute Split operation.	

Trouble shooting

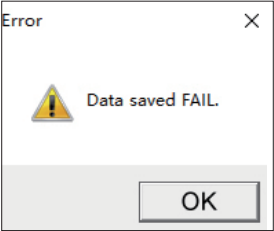
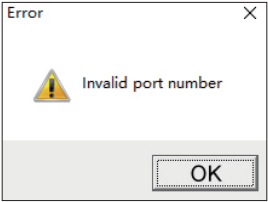
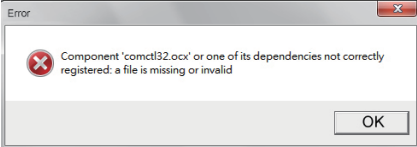
9	Question	The screen pops up as " Error " window just as shown in the right image when you make "Connect" during the second step.	
	Analysis	The communication between the PC and the projector's serial cable is wrong.	
	Solution	Check whether the PC and the projector are connected. If not, please connect them together before you execute Save operation.	
10	Question	The screen pops up as " Error " window about invalid port number just as shown in the right image.	
	Analysis	The serial connection is lost during your operation step especially when the USB connector is removed from the PC.	
	Solution	Check whether the PC and the serial cable are connected. Maybe users need make resetting before connecting them	
11	Question	The screen pops up as " Error " window about invalid port number just as shown in the right image.	
	Analysis	The software is not compatible with the PC system	
	Solution	Close the software, then right click the software to select "Run as administrator" to run up the software.	