

# EIKI

---

## OWNER'S MANUAL

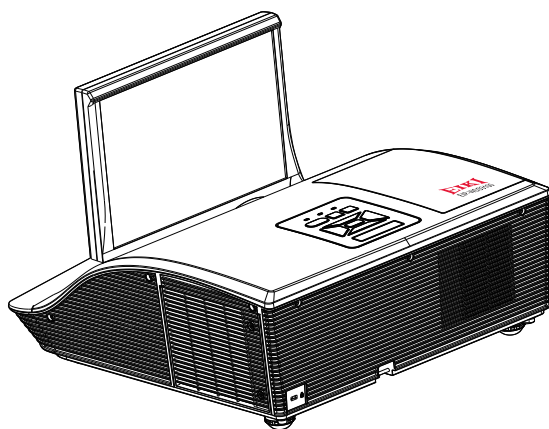

**EIP-WSS3100**

# Table of Contents

<b>Table of Contents</b>	<b>1</b>	Setting   Security.....	29
<b>Usage Notice</b>	<b>2</b>	Volume.....	30
Precautions .....	2	Options .....	31
Regulation & Safety Notices.....	4	Options   Lamp Settings.....	33
<b>Introduction</b>	<b>6</b>	3D .....	34
Package Overview .....	6	Interactive .....	35
Product Overview .....	7	LAN.....	36
Main Unit.....	7	Web Management.....	37
Control Panel.....	8	<b>Appendices</b>	<b>43</b>
Connection Ports .....	9	Troubleshooting.....	43
Remote Control.....	10	Image Problems.....	43
<b>Installation</b>	<b>11</b>	Projector Problems .....	46
Connecting to Computer/Notebook.....	11	Remote Control Problems .....	46
Connecting to Video Sources.....	12	Sound Problems .....	46
Powering On/Off the Projector .....	13	3D Problems .....	46
Powering On the Projector.....	13	On Screen Messages .....	47
Powering Off the Projector.....	14	Compatibility Modes.....	48
LED Indicator Messages.....	14	Replacing the lamp.....	52
Adjusting the Projected Image .....	15	Replacing and cleaning the optional dust filter.....	53
Adjusting the Projector's Height.....	15	Ceiling Mount Installation .....	54
Adjusting the Projector's Focus .....	16	Specifications .....	55
Adjusting Projection Image Size .....	16		
<b>User Controls</b>	<b>17</b>		
Using the Control Panel .....	17		
Using the Remote Control.....	18		
Remote Control Battery Installation .	19		
On-screen Display Menus .....	20		
How to operate .....	20		
Structure .....	21		
Picture.....	23		
Screen .....	25		
Setting.....	27		

# Usage Notice

## Precautions



*Please follow all warnings, precautions and maintenance as recommended in this user's guide.*

- Warning- Do not look into the projector's lens when the lamp is on. The bright light may hurt and damage your eyes.
- Warning- To avoid the risk of fire or electric shock, do not expose this projector to rain or moisture.
- Warning- Please do not open or disassemble the projector as this may cause electric shock.
- Warning- When replacing the lamp, please allow the unit to cool down. Follow instructions as described on pages 52.
- Warning- This projector will detect the life of the lamp itself. Please be sure to change the lamp when it shows warning messages.
- Warning- When the lamp is approaching the end of its lifetime, the message "Lamp Warning: Lamp life exceeded." will show on the screen. Please contact your local reseller or service center to change the lamp as soon as possible.
- Warning- Reset the "Clear Lamp Hours" function from the on-screen display "Options | Lamp Settings" menu after replacing the lamp module (refer to page 34).
- Warning- When switching the projector off, please ensure the cooling cycle has been completed before disconnecting power. Allow 90 seconds for the projector to cool down.
- Warning- Do not block the light path between the light source and the lens with any objects. Doing so could cause the object to catch on fire.

### **Do:**

- ❖ Turn off and unplug the power plug from the AC outlet before cleaning the product.
- ❖ Use a soft dry cloth with mild detergent to clean the display housing.
- ❖ Disconnect the power plug from AC outlet if the product is not being used for a long period of time.

### **Do not:**

- ❖ Clean the lens.



▪ *When the PJ-lens is dirty, please contact the service center. Do not own wipe to avoid scratching the lens.*

- ❖ Block the slots and openings on the unit provided for ventilation.
- ❖ Use abrasive cleaners, waxes or solvents to clean the unit.
- ❖ Use under the following conditions:
  - In extremely hot, cold or humid environments.
    - ▶ Ensure that the ambient room temperature is within 5 - 40°C.
    - ▶ Relative Humidity is 5 - 40°C, 80% (Max.), non-condensing.
  - In areas susceptible to excessive dust and dirt.
  - Near any appliance generating a strong magnetic field.
  - In direct sunlight.

## Regulation & Safety Notices

*This appendix lists the general notices of your projector.*

### ***FCC notice***

This device has been tested and found to comply with the limits for a Class B digital device pursuant to Part 15 of the FCC rules. These limits are designed to provide reasonable protection against harmful interference in a residential installation. This device generates, uses and can radiate radio frequency energy and, if not installed and used in accordance with the instructions, may cause harmful interference to radio communications.

However, there is no guarantee that interference will not occur in a particular installation. If this device does cause harmful interference to radio or television reception, which can be determined by turning the device off and on, the user is encouraged to try to correct the interference by one or more of the following measures:

- Reorient or relocate the receiving antenna.
- Increase the separation between the device and receiver.
- Connect the device into an outlet on a circuit different from that to which the receiver is connected.
- Consult the dealer or an experienced radio/television technician for help.

### ***Notice: Shielded cables***

All connections to other computing devices must be made using shielded cables to maintain compliance with FCC regulations.

### ***Caution***

Changes or modifications not expressly approved by the manufacturer could void the user's authority, which is granted by the Federal Communications Commission, to operate this projector.

## ***Operation conditions***

This device complies with Part 15 of the FCC Rules. Operation is subject to the following two conditions:

1. This device may not cause harmful interference and
2. This device must accept any interference received, including interference that may cause undesired operation.

## ***Notice: Canadian users***

This Class B digital apparatus complies with Canadian ICES-003.

## ***Remarque à l'intention des utilisateurs canadiens***

Cet appareil numérique de la classe B est conforme à la norme NMB-003 du Canada.

## ***Declaration of Conformity for EU countries***

- EMC Directive 2004/108/EC (including amendments)
- Low Voltage Directive 2006/95/EC
- R & TTE Directive 1999/5/EC (if product has RF function)

### **Disposal instructions**



**Do not throw this electronic device into the trash when discarding. To minimize pollution and ensure utmost protection of the global environment, please recycle it.**



# Introduction

## Package Overview

*Unpack and inspect the box contents to ensure all parts listed below are in the box. If something is missing, please contact our customer service.*

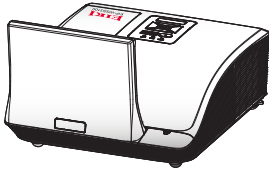

Projector



Remote Control



Battery

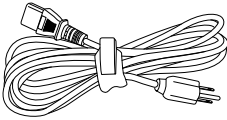

AC Power Cord

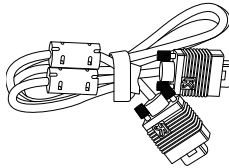

VGA Cable

### Documentation:

- User's Manual (CD)
- Quick Start Guide



■ Due to different applications in each Country, some regions may have different accessories.

# Product Overview

## Main Unit

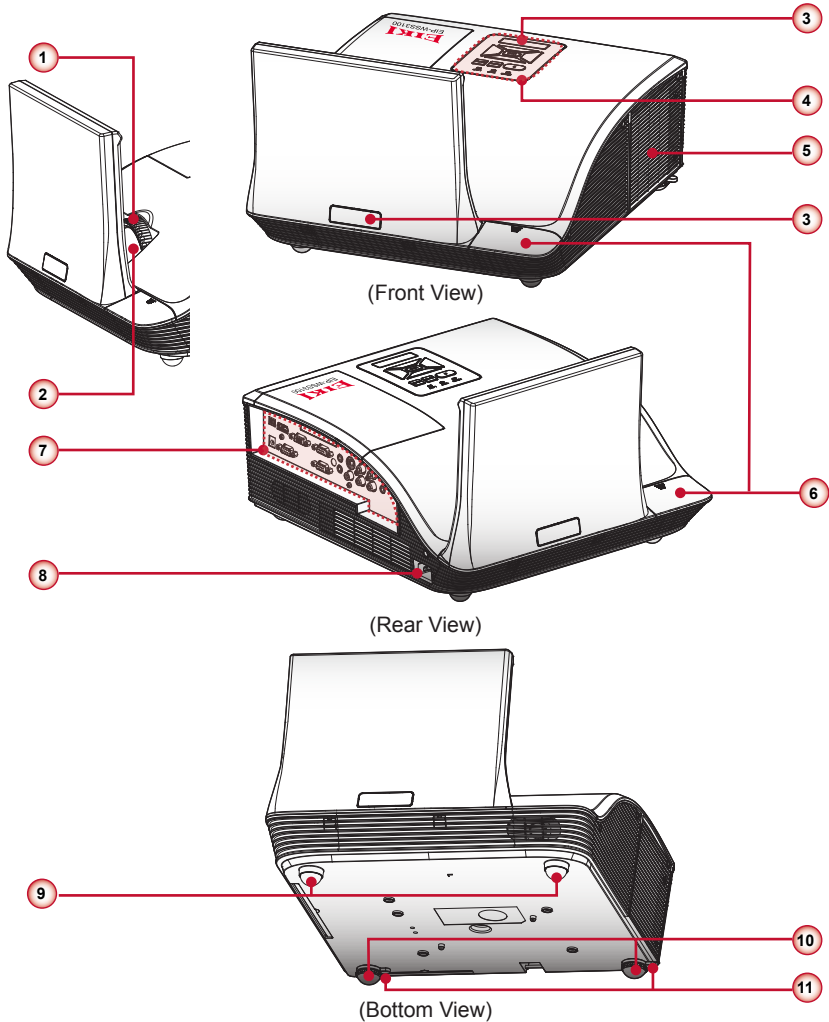

1. Focus Ring

2. Lens

3. IR Receiver

4. Control Panel

5. Lamp Cover

6. External Terminal Cover (Interactive Kit IK-US10)\*

7. Input / Output Connection Ports

8. Power Socket

9. Elevator Feet

10. Elevator Feet

11. Elevator Feet Spacer

\* Option



# Control Panel

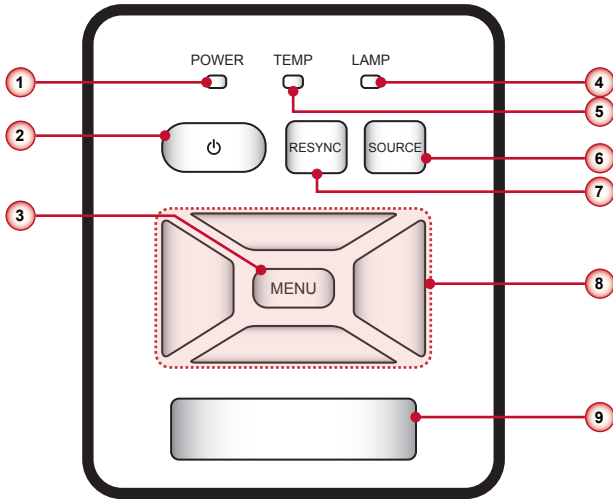

1. Power LED
2. Power 
3. Menu / Exit
4. Lamp LED
5. Temp (Temperature) LED
6. Source
7. Resync
8. Four Directional Select Keys
9. IR Receiver

## Connection Ports

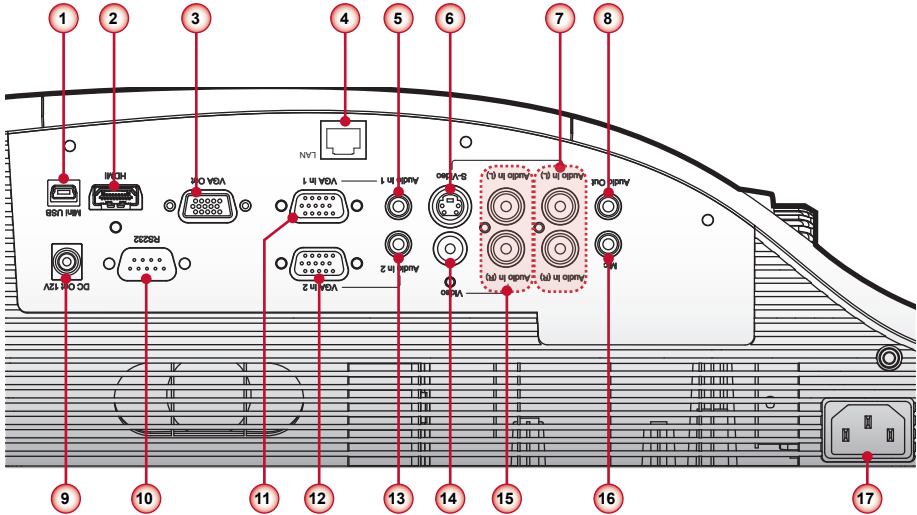

1. Mini USB Connector

2. HDMI Connector

3. VGA Output Connector

4. LAN Connector

5. Audio In 1 Connector (For VGA In 1 Connector)

6. S-Video Connector

7. Left/Right RCA Audio Input Connector (For S-Video Connector)

8. Audio Output Connector

9. 12V Trigger Relay Connector (12V, 250mA)

10. RS232 Connector

11. VGA In 1 Connector

12. VGA In 2 Connector

13. Audio In 2 Connector (For VGA In 2 Connector)

14. Composite Video Input Connector



15. Left/Right RCA Audio Input Connector (For Composite Video Input Connector)

16. 3.5mm Microphone Input Connector

17. Power Socket

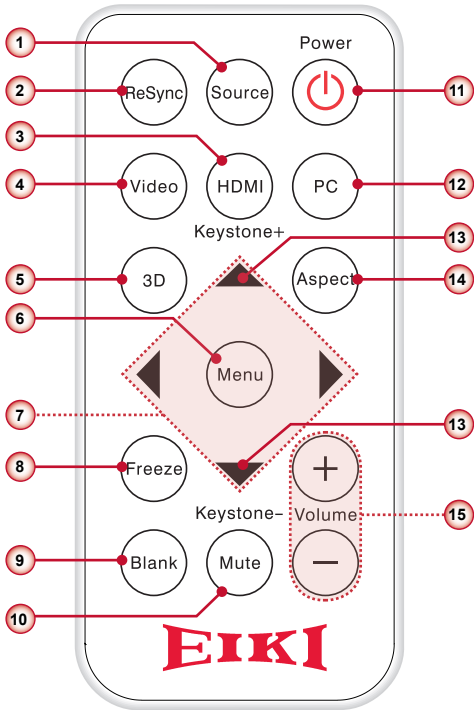
# Remote Control



1. Source
2. ReSync
3. HDMI
4. Video
5. 3D
6. Menu
7. Four Directional Select Keys
8. Freeze
9. Blank
10. Mute
11. Power 
12. PC
13. Keystone 
14. Aspect
15. Volume +/-

**Note** 

Before using the remote control for the first time, remove the transparent insulation tape. See page 19 for battery installation.

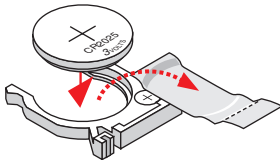

# Installation

## Connecting to Computer/Notebook

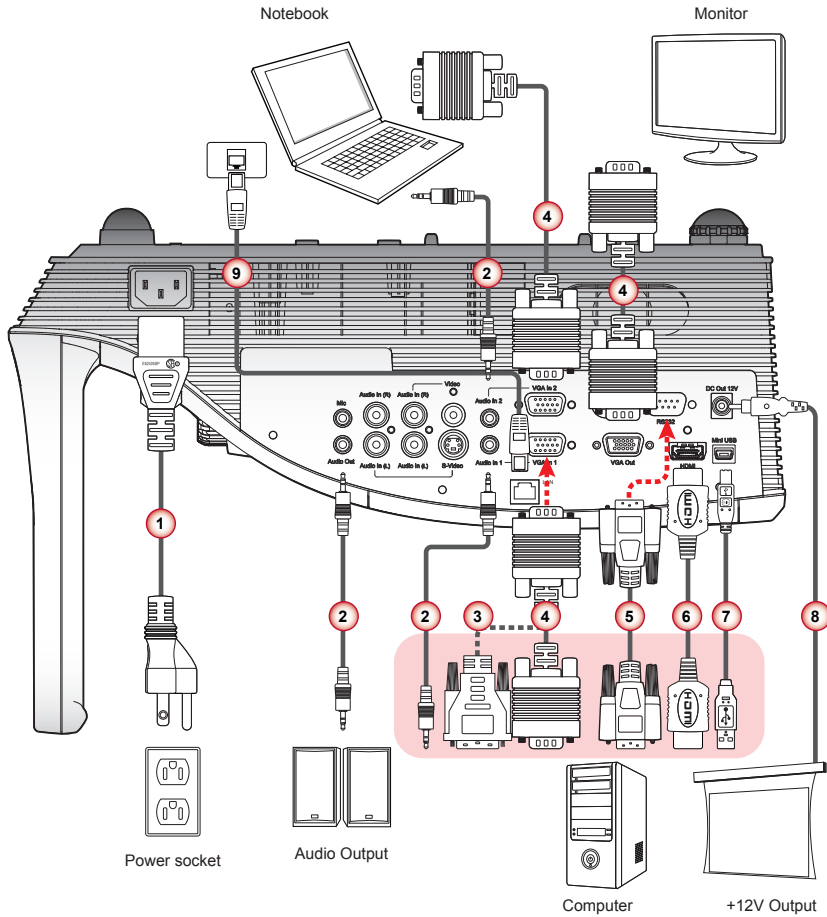

1. Power Cord
2. Audio Cable
3. VGA to DVI-A Cable
4. VGA Cable
5. RS232 Cable
6. HDMI Cable
7. USB Cable
8. 12V DC Jack
9. Network Cable



Due to the difference in applications for each country, some regions may have different accessories.

# Connecting to Video Sources

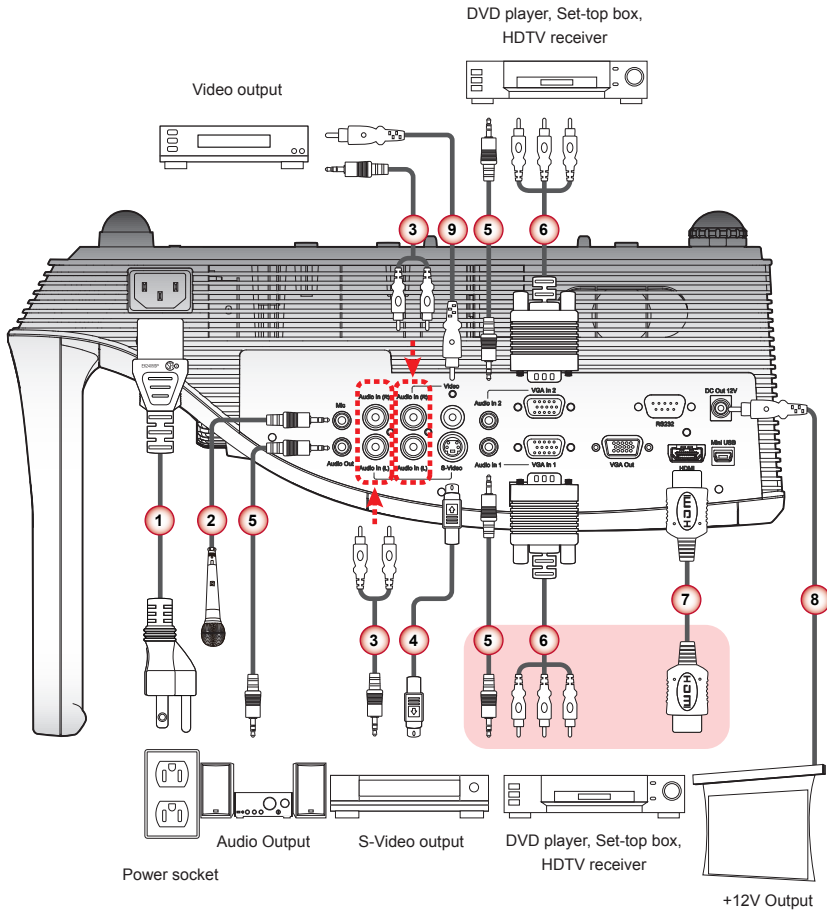

1. Power Cord
2. Microphone Cable
3. Audio Cable Jack/RCA
4. S-Video Cable
5. Audio Cable
6. VGA to HDTV (RCA) Cable
7. HDMI Cable
8. 12V DC Jack
9. Composite Video Cable



Due to the difference in applications for each country, some regions may have different accessories.

# Powering On/Off the Projector

## Powering On the Projector

1. Securely connect the power cord and signal cable. When connected, the Power LED will turn red.
2. Turn on the lamp by pressing “⏻” button on the control panel or on the remote control. The Power LED will turn blue.
3. Turn on your source that you want to display on the screen (computer, notebook, video player, etc). The projector will detect the source automatically and will display on the screen.
4. If you connected multiple sources at the same time, press the “Source” button on the remote control to switch between the inputs.

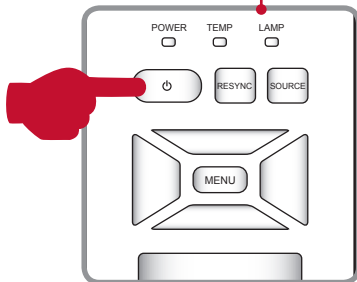
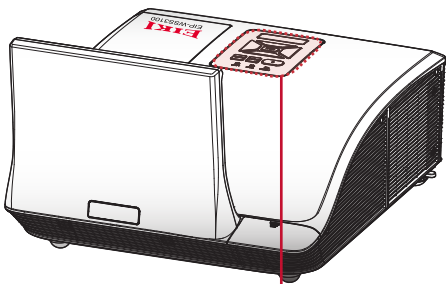

or



## Powering Off the Projector

1. Press the “⏻” button on the control panel or on the remote control to turn off the projector. The following message will be displayed on the screen. Press the “⏻” button again to confirm.

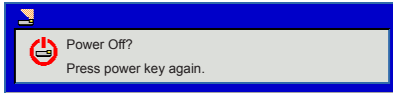

2. The Power LED will turn red and blink rapidly after the projector is turned off. And the fans will continue to operate for about 90 seconds to ensure that the system cools properly.
3. Once the system has finished cooling, the Power LED will stop blinking and turn solid red to indicate standby mode.
4. It is now safe to unplug the power cord.

## LED Indicator Messages

Message	Lamp LED (Red)	Temp LED (Red)	Power LED (Red)	Power LED (Blue)
Power Plug	Flash ON to OFF 100ms	Flash ON to OFF 100ms	Flash ON to OFF 100ms	-
Standby	-	-	ON	-
Power button ON	-	-	-	ON
Cooling state	-	-	0.5 second H(ON), 0.5 second L(OFF) flashing	-
Power button OFF: Cooling completed; Standby Mode	-	-	ON	-
Firmware download	ON	ON	ON	-
Thermal sensor error, OSD showing as below: 1. Make sure air in and outlets are not blocked. 2. Make sure the environment temperature is under 40 degree C.	-	ON	-	ON
Fan lock error, OSD showing as below: The projector will switch off automatically.	-	0.5 second H(On), 0.5 second L(Off) flashing	-	ON
Lamp error (Lamp, Lamp driver, Color wheel)	ON	-	-	ON

# Adjusting the Projected Image

## Adjusting the Projector's Height

The projector is equipped with elevator feet for adjusting the image height.

- To raise the image:

Use screw in feet to raise the image to the desired height angle and fine-tune the display angle. ❶

- To lower the image:

Use screw in feet to lower the image to the desired height angle and fine-tune the display angle. ❷

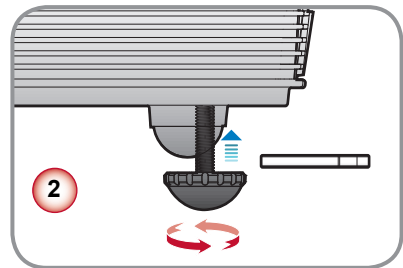
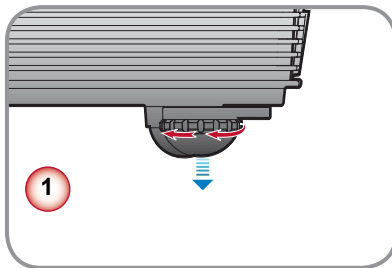
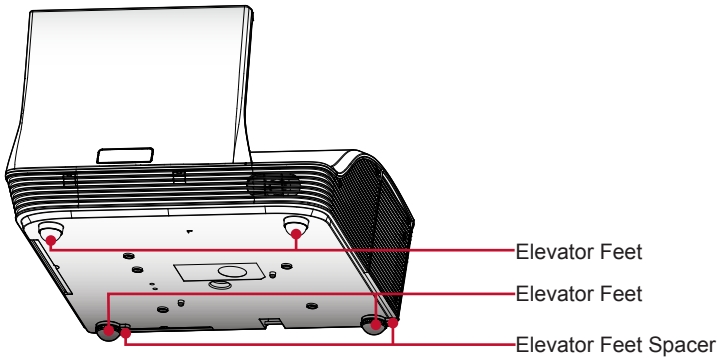



## Adjusting the Projector's Focus

To focus the image, rotate the focus ring until the image is clear.

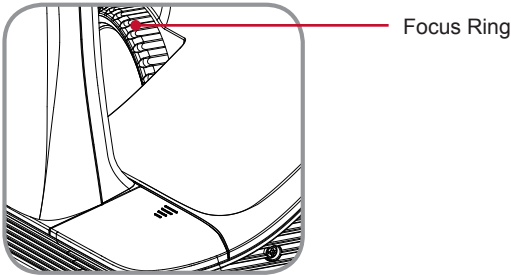

## Adjusting Projection Image Size

Refer to the graphics and table show as below to determine the screen size and projection distance.

- Adjusting the vertical image position

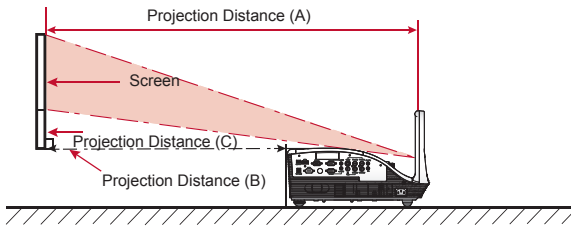

WXGA Series							
Screen Size (16:10)		Projection Distance (A)		Projection Distance (B)		Projection Distance (C)	
Diagonal (Inch)	mm	Inch	mm	Inch	mm	Inch	mm
70	1778	20.4	517	7.2	182	6.0	153
80	2032	23.5	596	10.3	262	7.4	187
87.2	2215	25.8	655	12.6	320	8.3	210
90	2286	26.7	677	13.5	343	8.6	219
100	2540	29.9	759	16.7	424	9.9	252





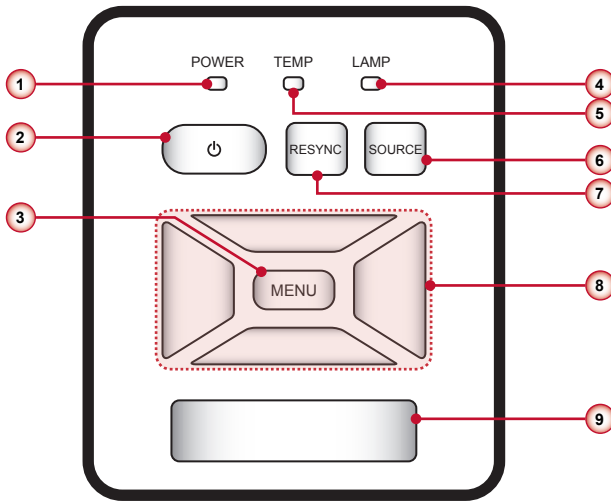

- Projection Distance A(mm)=Screen size(mm) x 0.296. Tolerance is around 3.1%  
Ex: Projection Distance (655mm)=Screen size(2215mm) x 0.296
- This table is for user's reference only.

# User Controls



## Using the Control Panel

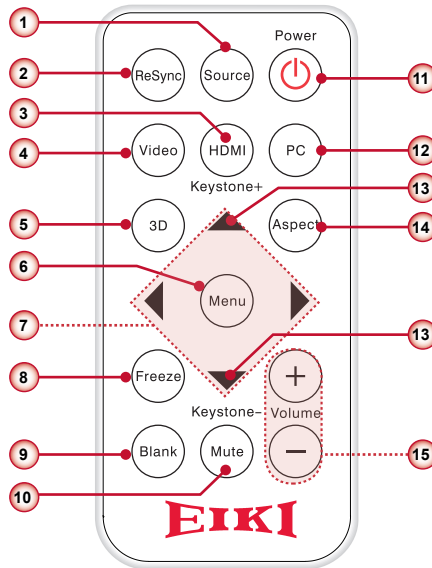

	Name	Description
1	Power LED	Indicate the projector's status
2	Power 	Turn the projector on/off.
3	Menu	Launch the on-screen display (OSD) / Exit a menu.
4	Lamp LED	Indicate the projector's lamp status.
5	Temp LED	Indicate the projector's temperature status.
6	Source	Select an input signal.
7	Resync	Automatically synchronize the PC analog timing to its optimized condition.
8	Four Directional Select Keys	Use     to select items or make adjustments to your selection.
9	IR Receiver	

# Using the Remote Control



Name	Description
1 Source	Select an input signal.
2 ReSync	Automatically synchronize the PC analog timing to its optimized condition.
3 HDMI	Switch to HDMI source.
4 Video	Switch to Composite Video or S-Video source.
5 3D	Press the “3D” to turn the 3D OSD menu on/off.
6 Menu	Launch or Exit the on-screen display(OSD).
7 Four Directional Select Keys	Press ▲▼◀▶ direction buttons to select items or make adjustments.
8 Freeze	Press to freeze the image. Press it again to un-freeze the image.
9 Blank	Hide the screen picture. Press again to display screen picture.
10 Mute	Mute the volume of speakers and audio out. Press again and switch to normal volume.
11 Power 	Power on/off the projector.
12 PC	Switch to VGA in 1/VGA in 2 source.
13 Keystone 	Adjust image until the sides are vertical.
14 Aspect	Use this function to choose your desired aspect ratio.
15 Volume +/-	Increase / decrease audio volume.

## Remote Control Battery Installation

1. Press firmly and slide the battery cover off.

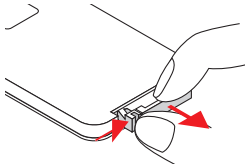

2. Install new battery into the compartment.

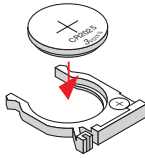

Remove the old battery and install new one (CR2025). Ensure that the side with a "+" is facing up.

3. Put the cover back.

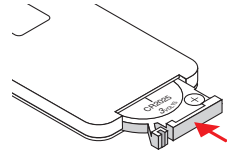

To ensure safe operation, please observe the following precautions :

- Use CR2025 type battery.
- Avoid contact with water or liquid.
- Do not expose the remote control to moisture or heat.
- Do not drop the remote control.
- If the battery has leaked in the remote control, carefully wipe the case clean and install new battery.
- Risk of an explosion if battery is replaced by an incorrect type.
- Dispose of used battery according to the instructions.

# On-screen Display Menus

The Projector has multilingual On-screen Display menus that allow you to make image adjustments and change a variety of settings. The projector will automatically detect the source.

## How to operate

1. To open the OSD menu, press the “Menu” button on the remote control or on the control panel.
2. When OSD is displayed, use the ◀▶▲▼ buttons to select the desired item and adjust the settings by the ◀▶ buttons.
3. If the setting has  icon, you could press the ▶ button to enter another sub menu. Press the “Menu” button to close the sub menu after adjustment.
4. After adjusting the settings, press the “Menu” button to go back to the main menu.
5. To exit, press the “Menu” button again. The OSD menu will be closed and the projector will automatically save the new settings.

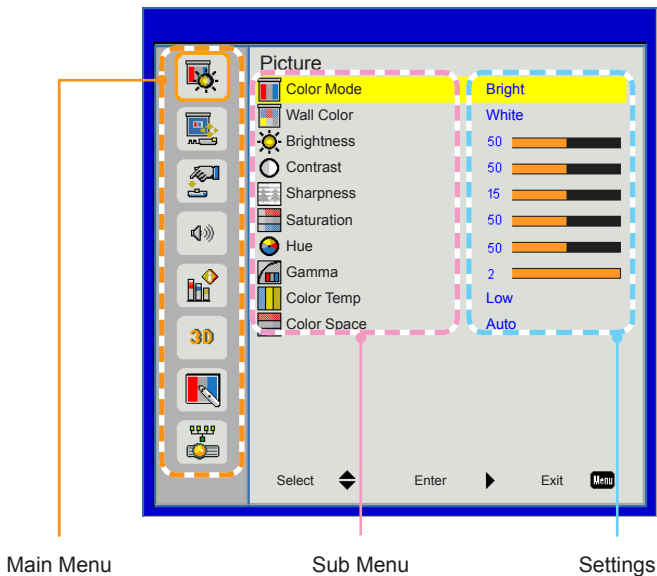

# Structure

Main Menu	Sub Menu	Settings	
<b>PICTURE</b>	Color Mode	Bright / PC / Movie / Game / User	
	Wall Color	White / Light Yellow / Light Blue / Pink / Dark Green	
	Brightness	0~100	
	Contrast	0~100	
	Sharpness	0~31	
	Saturation	0~100	
	Hue	0~100	
	Gamma	0~3	
	Color Temp.	Low / Mid / High	
	Color Space	AUTO / RGB / YUV	
	<b>SCREEN</b>	Aspect Ratio	AUTO / 4:3 / 16:9 / 16:10
		Phase	0~31
		Clock	-50~50
H. Position		-10~10	
V. Position		-10~10	
Digital Zoom		1~10	
V Keystone		-20~20	
Ceiling Mount		Front / Front Ceiling / Rear / Rear Ceiling	
<b>SETTING</b>	Language	English / Deutsch / Español / Français / Italiano / Nederlands / Português / 日本語 / 简体中文 / Polski / 한국어 / Русский / Svenska / 繁體中文 / عربي / Norsk / Türkçe	
	Menu Location		
	Closed Caption	Off / CC1 / CC2 / CC3 / CC4	
	VGA Out (Standby)	Off / On	
	LAN(Standby)	Off / On	
	Auto Screen(12V out)	Off / On	
	Test Pattern	Off / On	
	Security	Security	
		Change Password	000000
	Reset	No / Yes	
	<b>Volume</b>	Mute	Off / On
		Volume	0~32
		Microphone Volume	0~32
	<b>OPTIONS</b>	Logo	Default / User
		Logo Capture	
Auto source		Off / On	
Input		HDMI / VGA 1 / VGA 2 / S-Video / COMPOSITE	
Auto Power Off (min)		0~120	
Lamp Setting		Lamp Hours Used (Normal)	
		Lamp Hours Used (ECO)	
		Lamp Life Reminder	Off / On
		Lamp Power Mode	Normal / ECO
		Clear Lamp Hours	No / Yes
Dynamic Black		Off / On	
High Altitude		Off / On	
Dust Filter Reminder		Filters Remind(Hour)	
		Cleaning Up Reminder	No / Yes
Information		Model Name / SNID / Source / Resolution / Software Version / Color Space / Aspect Ratio	

Main Menu	Sub Menu	Settings	
<b>3D</b>	3D	AUTO / Off / On	
	3D Invert	Off / On	
	3D Format	Frame Packing / Side-by-Side (Half) / Top and Bottom / Frame Sequential / Field Sequential	
	1080p @ 24	96Hz / 144Hz	
<b>Interactive</b>	Interactive Settings	Off / IR Camera	
<b>LAN</b>	LAN Settings	DHCP	Off / On
		IP Address	
		Subnet mask	
		Gateway	
		DNS	
		Store	No / Yes
		Reset	No / Yes

# Picture

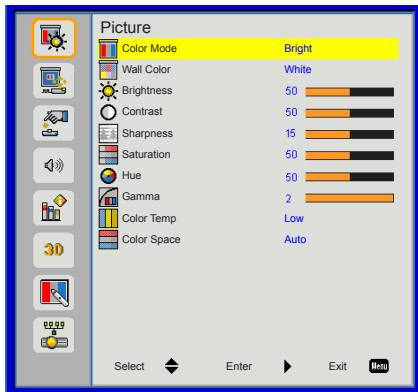

## Color Mode

There are many factory presets optimized for various types of images. Use the ◀ or ▶ button to select the item.

- ▶ Bright: For brightness optimization.
- ▶ PC: For meeting presentation.
- ▶ Movie: For playing video content.
- ▶ Game: For game content.
- ▶ User: Memorize user's settings.

## Wall Color

Use this function to choose a proper color according to the wall. It will compensate the color deviation due to the wall color to show the correct image tone.

## Brightness

Adjust the brightness of the image.

- ▶ Press the ◀ button to darken image.
- ▶ Press the ▶ button to lighten the image.

## Contrast

The Contrast controls the difference between the lightest and darkest parts of the picture. Adjusting the contrast changes the amount of black and white in the image.

- ▶ Press the ◀ button to decrease the contrast.
- ▶ Press the ▶ button to increase the contrast.



## Sharpness

Adjust the sharpness of the image.

- ▶ Press the ◀ button to decrease the sharpness.
- ▶ Press the ▶ button to increase the sharpness.

## Saturation

Adjust a video image from black and white to fully saturated color.

- ▶ Press the ◀ button to decrease the amount of saturation in the image.
- ▶ Press the ▶ button to increase the amount of saturation in the image.

## Hue

Adjust the color balance of red and green.

- ▶ Press the ◀ button to increase the amount of green in the image.
- ▶ Press the ▶ button to increase the amount of red in the image.



▪ "Sharpness", "Saturation" and "Hue" functions are only supported under video mode.

## Gamma

Effects the representation of dark scenery. With greater gamma value, dark scenery will look brighter.

## Color Temp.

Adjust the color temperature. At higher temperature, the screen looks colder; at lower temperature, the screen looks warmer.

## Color Space

Select an appropriate color matrix type from Auto, RGB or YUV.

# Screen



## Aspect Ratio

- ▶ Auto: Keep the image with original width-height ratio and maximize the image to fit native horizontal or vertical pixels.
- ▶ 4:3: The image will be scaled to fit the screen and displayed using a 4:3 ratio.
- ▶ 16:9: The image will be scaled to fit the width of the screen and the height adjusted to display the image using a 16:9 ratio.
- ▶ 16:10: The image will be scaled to fit the width of the screen and the height adjusted to display the image using a 16:10 ratio.

## Phase

Synchronize the signal timing of the display with the graphic card. If the image appears to be unstable or flickers, use this function to correct it.

## Clock

Change the display data frequency to match the frequency of your computer's graphic card. Use this function only if the image appears to flicker vertically.

## H. Position

- ▶ Press the ◀ button to move the image left.
- ▶ Press the ▶ button to move the image right.

## V. Position

- ▶ Press the ◀ button to move the image down.
- ▶ Press the ▶ button to move the image up.



■ "H. Position" and "V. Position" ranges will depend on input source.

## Digital Zoom

Press the ◀ button to reduce the size of an image.

Press the ▶ button to magnify an image on the projection screen.

## V Keystone

Press the ◀ or ▶ button to adjust image distortion vertically. If the image looks trapezoidal, this option can help make the image rectangular.

## Ceiling Mount

- ▶ Front: The image is projected straight on the screen.
- ▶ Front Ceiling: This is the default selection. When selected, the image will turn upside down.
- ▶ Rear: When selected, the image will appear reversed.
- ▶ Rear Ceiling: When selected, the image will appear reversed in upside down position.

# Setting

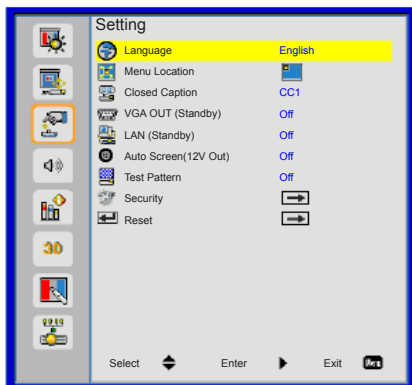

## Language

Choose the multilingual OSD menu. Press the ◀ or ▶ button into the sub menu and then use the ▲ or ▼ button to select your preferred language. Press ▶ on the remote control to finalize the selection.



## Menu Location

Choose the menu location on the display screen.

## Closed Caption

Use this function to enable closed caption menu. Select an appropriate closed captions option: Off, CC1, CC2, CC3, CC4.

## LAN (Standby)

Choose "On" to enable LAN connection. Choose "Off" to disable LAN connection.

## VGA OUT (Standby)

Choose "On" to enable VGA OUT connection.

### Auto Screen (12V Out)

Choose "On", the down/up move of electronic screen will be related with power on/off of Projector.

### Test Pattern

Display a test pattern.

### Security

Refer next page.

### Reset

Choose "Yes" to return the parameters on all menus to the factory default settings.

## Setting | Security



### Security

- ▶ On: Choose “On” to use security verification when turning on the projector.
- ▶ Off: Choose “Off” to be able to switch on the projector without password verification.

### Change Password

- ▶ First time:
  - Press the ▶ button to set the password.
  - The password has to be 6 digits.
  - Use the ▲ or ▼ on the remote control to select your new password on the screen and then press ▶ to confirm it.
- ▶ Change Password:
  - Use the ▲ or ▼ on the remote control to enter your current password on the screen and then press ▶ to confirm it.
  - Enter a new password (6 digits in length) then press “Enter” to confirm it.
  - Enter the new password again and press “Enter” to confirm it.
- ▶ If the incorrect password is entered for 3 times, the projector will automatically shut down.
- ▶ If you have forgotten your password, please contact your local office for support.



- Password default value is “000000” (first time).

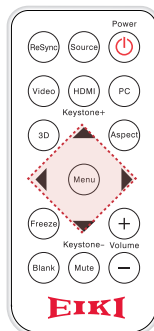

# Volume

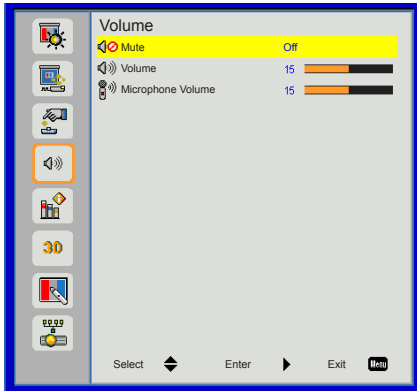

## Mute

- ▶ Choose "On" to turn mute on.
- ▶ Choose "Off" to turn mute off.

## Volume

- ▶ Press the ◀ button to decrease the volume.
- ▶ Press the ▶ button to increase the volume.

## Microphone Volume

- ▶ Press the ◀ button to decrease the microphone Volume.
- ▶ Press the ▶ button to increase the microphone Volume.

# Options

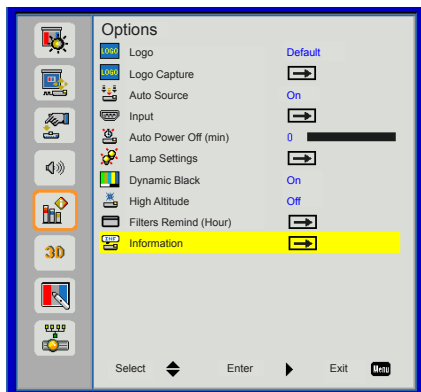

## Logo

Use this function to set the desired startup screen. If changes are made they will take effect the next time the projector is powered on.

- ▶ Default: The default startup screen.
- ▶ User: Use stored picture from “Logo Capture” function.

## Logo Capture

Press ▶ button to capture an image of the picture currently displayed on screen.

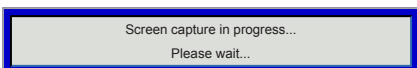

### Note

- For successful logo capture, please ensure that the onscreen image does not exceed the projector's native resolution. (WXGA:1280x800).
- “Logo Capture” is not available when 3D is enabled.
- Before active this function, it is recommended that “Aspect Ratio” is set to the “Auto”.

## Auto Source

- ▶ On: The projector will search for other signals if the current input signal is lost.
- ▶ Off: The projector will only search current input connection.

## Input

Press ▶ button to enable/disable input sources. The projector will not search for inputs that are not selected.



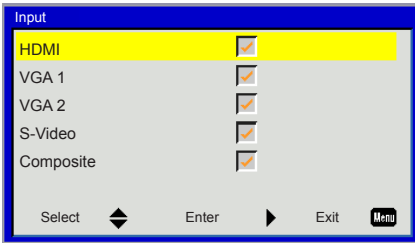

### Auto Power Off (min)

Sets the countdown timer interval. The countdown timer will start, when there is no signal being sent to the projector. The projector will automatically power off when the countdown has finished (in minutes).

### Lamp Setting

Refer to page 33.

### Dynamic Black

- ▶ On: The pictures with the optimum contrast will be displayed by automatically providing signal compensation to suit the pictures concerned.
- ▶ Off: Turn off this function.

#### **Note**

- "Dynamic Black" is available when "Color Mode" is set to "Movie".
- "Dynamic Black" is not available when "3D" or "Interactive" is enabled.
- When "Dynamic Black" is available, "Lamp Power Mode" selection is not available.

### High Altitude

- ▶ On: The built-in fans run at high speed. Select this option when using the projector at altitudes above 2500 feet/762 meters or higher.
- ▶ Off: The built-in fans automatically run at a variable speed according to the internal temperature.

### Filters Remind (Hour)

- ▶ Filters Remind (Hour): Set the filter reminder time
- ▶ Cleaning Up Reminder: Select "Yes" to reset the dust filter hour counter after replacing or cleaning the dust filter.

### Information

Display the projector information for model name, SNID, source, resolution, software version, color space and aspect ratio on the screen.

## Options | Lamp Settings

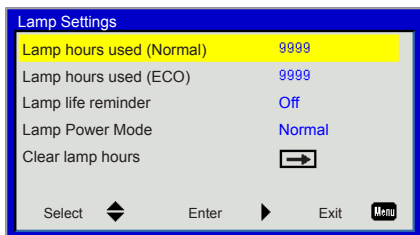

### Lamp Hours Used (Normal)

Display the projection time of normal mode.

### Lamp Hours Used (ECO)

Display the projection time of ECO mode.

### Lamp Life Reminder

- ▶ On: Choose "On" to show the lamp end of life warning message.
- ▶ Off: Choose "Off" to hide the lamp end of life warning message.

### Lamp Power Mode

- ▶ Normal: Normal mode.
- ▶ ECO: Use this function to dim the projector lamp which will lower power consumption and extend the lamp life.

### Clear Lamp Hours

Choose "Yes" to reset the lamp hour counter after replacing the lamp.

## 3D

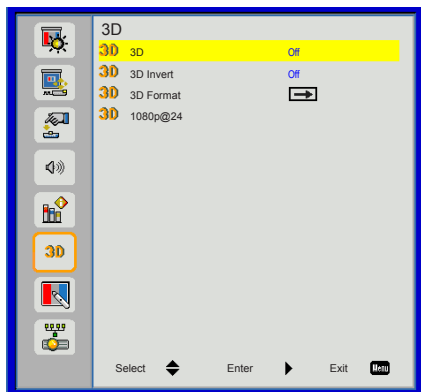

### 3D

- ▶ Auto: When a HDMI1.4a 3D timing identification signal is detected, the 3D image is selected automatically.
- ▶ Choose “Off” to disable 3D function.
- ▶ Choose “On” to enable 3D function.

### 3D Invert

If you see a discrete or overlapping image while wearing DLP 3D glasses, you may need to execute “Invert” to get best match of left/right image sequence to get the correct image.

### 3D Format

Use this feature to select the 3D format. Options are: “Frame Packing”, “Side-by-Side (Half)”, “Top and Bottom”, “Frame Sequential” and “Field Sequential”.

#### **Note**

- “Frame Sequential” is supported the DLP Link 3D input signals from VGA / HDMI connector.
- “Frame Sequential” / “Field Sequential” are supported the HQFS 3D input signals from Composite/S-video connector connector.
- “Frame Packing” / “Side-by-Side(Half)” / “Top and Bottom” are supported from HDMI 1.4a 3D input signals.

### 1080p @24

Use this feature to select 96 or 144Hz refresh rate as using 3D glasses in the 1080p @ 24 frame packing.

# Interactive

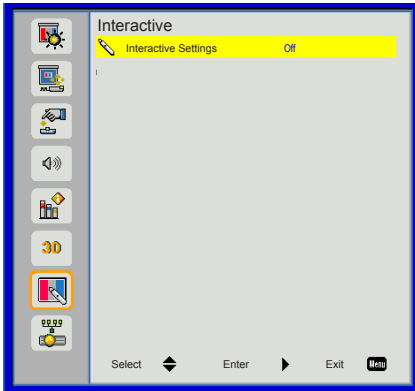

**Note**

- The Interactive function is available when displaying graphic source from HDMI/VGA input. Other sources are not supported.
- If "3D" or "Dynamic Black" function is enabling, "Interactive" feature is disabling.

## Interactive Settings

Use this feature to select the Interactive Pen function.

- ▶ Choose "Off" to disable the Interactive Pen function.
- ▶ Choose "IR Camera" to enable the Interactive Pen function.

You need to unplug the Mini USB cable that connects NB/desktop with the projector before using the Interactive function. After you complete the Interactive Settings in OSD, use Mini USB cable to connect NB/desktop with the projector.

The IR camera Interactive function needs an external IR camera. Please refer to below figure and plug in IR camera to projector before projector was installed.

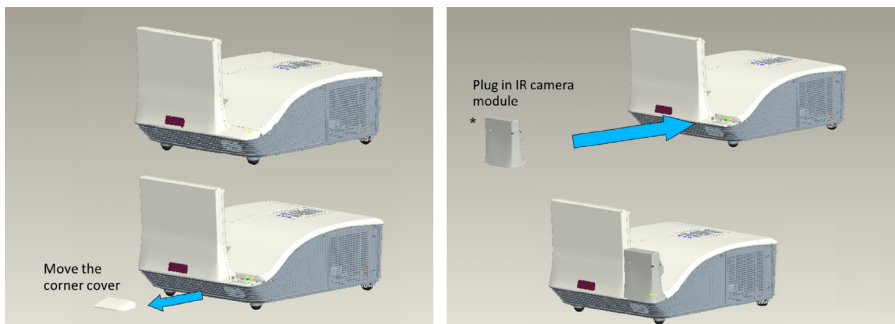

(\*)Interactive Kit IK-US10 (Option)

# LAN



- ▶ **DHCP:** If a DHCP server exists in the network to which the projector is connected, the IP address will automatically be acquired when you select DHCP On. If DHCP is Off, manually set the IP Address, Subnet Mask, and Gateway. Use ▲ or ▼ to select the number of IP address, Subnet Mask, and Gateway.
- ▶ **IP Address:** Select an IP address.
- ▶ **Subnet Mask:** Configure the Subnet Mask of the LAN connection.
- ▶ **Gateway:** Check the Gateway address with your network/system administrator if you configure it manually.
- ▶ **DNS:** Check the DNS Server IP address with your network/system administrator if you configure it manually.
- ▶ **Store:** Choose “Yes” to save the changes made in network configuration settings.
- ▶ **Reset:** Choose “Yes” to return the display parameters on all menus to the factory default settings.

## Web Management

1. Turn on DHCP to allow a DHCP server to automatically assign an IP, or manually enter the required network information.

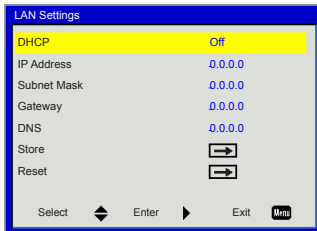

2. Open your web browser and type in IP Address from the OSD LAN.
3. Based on network web-page for the input-string in [tools] tab, the limitation for Input-Length is in the below list ("space" and the other punctuation key included):

Category	Item	Input-Length (characters)
Projector	Projector Name	21
	Location	21
	Administrator	21
Admin Password	New Password	4
	Confirm	4

Note: The characters allowed to be input are 0-9, and a-Z.



- Use Internet Explore 7/8/9 or Safari version 5.0.3 to enter the IP address. You can now access Web Management and manage the projector from a remote location.

## When making a direct connection from your computer to the projector

Step 1: Find an IP Address (192.168.10.100) from LAN function of projector.

Step 2: To open Network Connections, click **Start**, click **Control Panel**, click **Network and Internet Connections**, and then click **Network Connections**. Click the connection you want to configure, and then, under **Network Tasks** , click **Change settings of this connection**.

Step 3: On the **General** tab, under **This connection uses the following items**, click **Internet Protocol (TCP/IP)**, and then click "Properties."

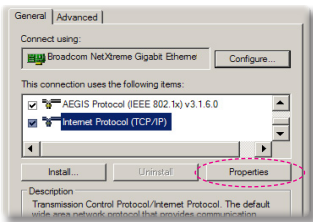

Step 4: Click **Use the following IP address**, and type in as below:

- ▶ IP address: 192.168.10.99
- ▶ Subnet mask: 255.255.255.0

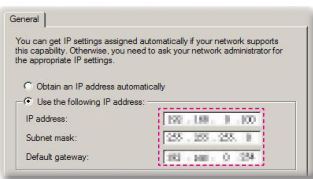

Step 5: To open Internet Options, click IE web browser, click Internet Options, click the **Connections** tab and click "LAN Settings..."

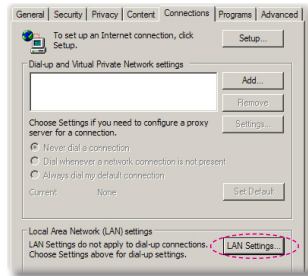

Step 6: The **Local Area Network (LAN) Setting** dialog box appears, In the **Proxy Server** area, cancel the **Use a proxy server for your LAN** check box., then click "OK" button twice.

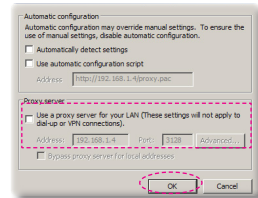

Step 7: Open your IE and type in the IP address of 192.168.10.100 in the URL then press "Enter" key.

# Projector Information Page

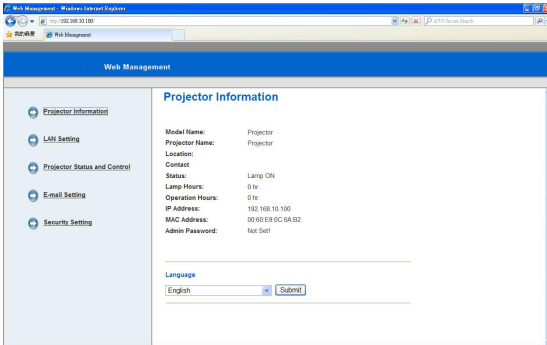

- ▶ Projector Information page by entering the projector’s IP address at the web browser. See “LAN Settings” section.
- ▶ Language: Allows you to set the language for web management.

# LAN Settings Page

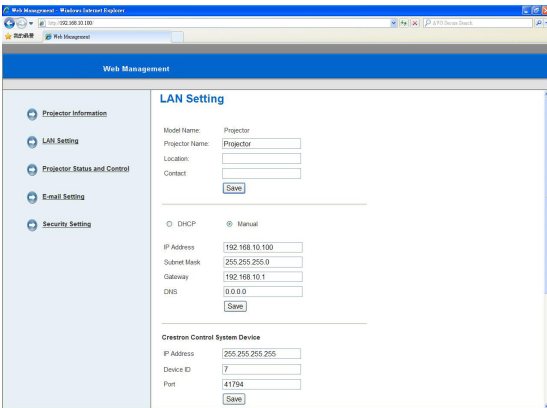

- ▶ Set up the Projector Name, Location and Administrator information (up to 21 characters for each field). Press Save to store the settings.
- ▶ Choose DHCP to assign an IP address to the projector from a DHCP server automatically, or Manual to assign an IP address manually.
- ▶ Set up the IP Address, Device ID and Port information on the Crestron function.



# Projector Status and Control Page

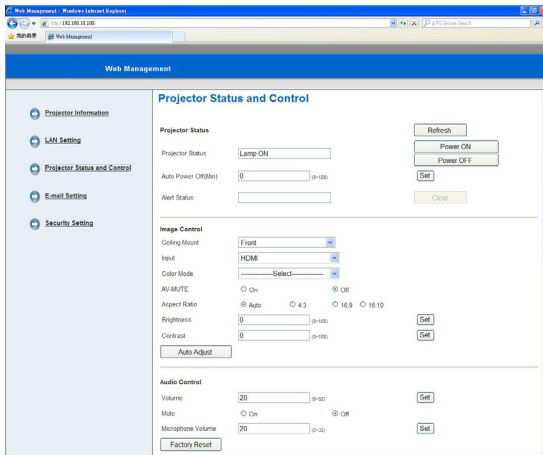

- ▶ **Projector Status:** There are 4 status: Standby, Warning up, Lamp On, Power Saving and Cooling. Click the Refresh button to refresh the status and control settings.
- ▶ **Auto Power Off:** Auto Power Off can be set to Off(0) or 1~120 minutes. See “Auto Power Off (min)” function.
- ▶ **Alert Status:** There are three error status: Lamp warning, Low lamp life, and Temperature warning. Your projector might lock up in protection mode if any of the alerts is activated. To exit protection mode, click the Clear to clear the Alert Status before you could Power ON your projector.
- ▶ **Ceiling Mount:** Allows you to select the projector mode, depending on how the projector is mounted. There are four projection modes: Front, Front Ceiling, Rear and Rear Ceiling. See “Ceiling Mount” function.
- ▶ **Source Select:** The Source Select menu allows you to select your projector's input source. You can select HDMI, VGA 1/VGA 2, S-Video and Composite Video.
- ▶ **Color Mode:** Select a mode to optimize the display image based on how the projector is being used. See “Color Mode” function.
- ▶ **Blank Screen:** Select On/Off to hide/unhide the screen picture.
- ▶ **Aspect Ratio:** Allows you to select the aspect ratio to adjust how the image appears.
- ▶ **Brightness:** Select value to adjust the brightness of the image.
- ▶ **Contrast:** Select value to adjust the display contrast.
- ▶ **Volume:** Select the value (0~32) for the audio volume
- ▶ **Mute:** Choose “On” to turn mute on. Choose “Off” to turn mute off.
- ▶ **Microphone Volume:** Select the value (0~32) for the Microphone Volume.



- Click the Auto Adjust button to adjust the settings automatically.
- Click the Factory Reset button to restore the factory default settings.

## E-mail Setting Page

The screenshot shows the 'E-mail Setting' page in a web browser. The page title is 'E-mail Setting'. On the left, there is a navigation menu with options: 'Projector Information', 'LMI Setting', 'Projector Status and Control', 'E-mail Setting', and 'Security Setting'. The main content area is divided into three sections: 'E-mail Alert', 'SMTP Setting', and 'Alert Condition'. In the 'E-mail Alert' section, there are radio buttons for 'Enable' and 'Disable', and an 'E-mail Alert Test' button. Below these are input fields for 'TO', 'CC', 'From', and 'Subject'. The 'SMTP Setting' section has an input field for 'Out going SMTP server'. The 'Alert Condition' section has checkboxes for 'Lamp warning', 'Lamp life reminder', and 'Temperature warning', and a 'Save' button.

- ▶ E-mail Alert: You can set whether to be notified by email (Enable) or not (Disable).
- ▶ To/Cc/From: You can enter email address of sender (From) and recipients (To/Cc) to receive notification when an abnormality or warning occurs.
- ▶ SMTP setting: Out going SMTP server, User name, and Password should be provided by your network administrator or MIS.
- ▶ Alert Condition: You can select the abnormalities or warnings to be notified by email. When any of the alert conditions occur, an email will be sent to the recipients (To/Cc).



- Click the Save button to save the settings.

## Security Setting Page

The screenshot shows the 'Security Setting' page in a web browser. The page title is 'Security Setting'. On the left, there is a navigation menu with options: 'Projector Information', 'LMI Setting', 'Projector Status and Control', 'E-mail Setting', and 'Security Setting'. The main content area is divided into two sections: a message and an 'Administrator' section. The message says: 'Please set your password if you enable this feature for first time. If password is set, you will require to enter with your password upon you connect to the Web Management.' The 'Administrator' section has radio buttons for 'Enable' and 'Disable', and a 'Submit' button. Below these are input fields for 'Password', 'New Password', and 'Confirm Password', each with its own 'Submit' button.

- ▶ Set up an administrator password to access the Web Management.  
Step 1. Password: Click Enable first.  
Step 2. New Password: Enter the new password.  
Step 3. Confirm Password: Confirm the new password then Submit  
Step 4. Password: Click Enable then Submit.



- Contact Service Center if you forget your administrator password.

## Login Page

Web Management

Welcome to Web Management.

Administrator Password:

Login

Projector Information  
Projector Name: D21211  
IP Address: 192.168.0.100

- ▶ Administrator Password: Enter the Administrator Password and click Login button.

## Crestron

- ▶ For more information, please visit <http://www.crestron.com> & [www.crestron.com/getroomview/](http://www.crestron.com/getroomview/)

# Appendices

## Troubleshooting

*If you experience a problem with your projector, please refer to the following information. If a problem persists, please contact your authorized dealer.*

### Image Problems



#### **No image appears on-screen**

- ▶ Ensure all the cables and power connections are correctly and securely connected as described in the “Installation” section.
- ▶ Ensure the pins of connectors are not crooked or broken.
- ▶ Check if the projection lamp has been securely installed.
- ▶ Ensure that the “Blank” feature is not turned on.



#### **Partial, scrolling or incorrectly displayed image**

- ▶ Press “Auto Sync” on the remote control.
  - If you are using a PC:
    - For Windows 95, 98, 2000, XP:
      1. Open the “My Computer” icon, the “Control Panel” folder, and then double click on the “Display” icon.
      2. Select the “Settings” tab.
      3. Verify that your display resolution setting is lower than or equal to 1080p.
    - For Windows Vista, Windows 7:
      1. From the “My Computer” icon, open the “Control Panel” folder, and double click the “Appearance and Personalization”
      2. Select “Display”.
      3. Click “Adjust resolution” to display “Screen resolution”.
      4. Verify that your display resolution setting is lower than or equal to 1080p.

- If the projector is still not projecting the whole image, you will also need to change the monitor display you are using. Refer to the following steps.
  1. Select the “Change” under the “Monitor” tab.
  2. Click on “Show all devices”. Next, select “Standard monitor types” under the SP box; choose the resolution mode you need under the “Models” box.
  3. Verify that the resolution setting of the monitor display is lower than or equal to 1080p.
- If you are using a Notebook:
  - First, follow the steps above to adjust resolution of the computer.
  - Press the toggle output settings. example: [Fn]+[F4]

Notebook Brand	Function Keys
Acer	[Fn]+[F5]
Asus	[Fn]+[F8]
Dell	[Fn]+[F8]
Gateway	[Fn]+[F4]
IBM/Lenovo	[Fn]+[F7]
HP/Compaq	[Fn]+[F4]
NEC	[Fn]+[F3]
Toshiba	[Fn]+[F5]
Mac Apple	System Preference -> Display -> Arrangement -> Mirror display

- If you experience difficulty changing resolutions or your monitor freezes, restart all equipment including the projector.

### **? The screen of the Notebook or PowerBook computer is not displaying your presentation**

Some Notebook PCs may deactivate their own screens when a second display device is in use. Each has a different way to be reactivated. Refer to your computer’s documentation for detailed information.

### **? Image is unstable or flickering**

- ▶ Adjust the “Phase” to correct it. Refer to the “Screen” section on pages 25 for more information.
- ▶ Change the monitor color setting from your computer.

### ? **Image has vertical flickering bar**

- ▶ Use “Clock” to make an adjustment. Refer to the “Screen” section for more information.
- ▶ Check and reconfigure the display mode of your graphic card to make it compatible with the product.

### ? **Image is out of focus**

- ▶ Adjust the “Focus Ring” on the projector lens.
- ▶ Make sure the projection screen is within the required distance. Refer to Page 16.

### ? **The image is stretched when displaying 16:9 DVD title**

When you play anamorphic DVD or 16:9 DVD, the projector will show the best image in 16: 9 format on projector side.

- ▶ If you play 4:3 format DVD title, please change the format as 4:3 in projector OSD.
- ▶ If the image is still stretched, you will also need to setup the display format as 16:9 (wide) aspect ratio type on your DVD player.

### ? **Image is too small or too large**

- ▶ Move the projector closer to or further from the screen.
- ▶ Press “Menu” on the remote control or on the control panel. Go to “Screen” --> “Aspect Ratio” and try the different settings.

### ? **Image has slanted sides:**

- ▶ If possible, reposition the projector so that it is centered on the screen and below the bottom of the screen.
- ▶ Use “Screen” --> “V Keystone” from the OSD to make an adjustment.

### ? **Image is reversed**

- ▶ Select “Screen” --> “Ceiling Mount” from the OSD and adjust the projection direction.

## Projector Problems

### ? The projector stops responding to all controls

- ▶ If possible, turn off the projector, then unplug the power cord and wait at least 20 seconds before reconnecting power.

### ? Lamp burns out or makes a popping sound

- ▶ When the lamp reaches its end of life, it will burn out and may make a loud popping sound. If this happens, the projector will not turn on until the lamp module has been replaced. To replace the lamp, follow the procedures in the “Replacing the Lamp” section on pages 52.

## Remote Control Problems

### ? If the remote control does not work

- ▶ Check the operating angle of the remote control is within  $\pm 30^\circ$  both horizontally and vertically of one of the IR receivers on the projector.
- ▶ Make sure there are not any obstructions between the remote control and the projector. Move to within 7 m ( $\pm 0^\circ$ ) of the projector.
- ▶ Make sure the batteries are inserted correctly.
- ▶ Replace batteries if they are exhausted.

## Sound Problems

### ? If no sound from the projector

- ▶ If you are playing an external source, make sure you have an audio cable securely connected between the source device and the projector's audio input.
- ▶ Please make sure the external speakers are not connected.
- ▶ Make sure the volume is not set to minimum.
- ▶ Make sure the “Volume --> Mute” function is set to “Off”.

## 3D Problems

### ? Blurry double image

- ▶ Select “3D” --> “3D” from OSD and choose “Off” to avoid normal 2D image is blurry double image.

## ? Two images, Side-by-Side(Half) format

- ▶ Select “3D” --> “3D Format” from OSD and choose “Side-by-Side(Half)” for input signal is HDMI 1.4a 3D. 3D Format is only supported on 3D Timing on page 51.

## ? Image does not display in 3D

- ▶ Check if the battery of 3D glasses is drained.
- ▶ Check if the 3D glasses is turned on.
- ▶ Select “3D” --> “3D Format” from OSD and choose “Side-by-Side(Half)” for input signal is HDMI 1.4a 3D. 3D Format is only supported on 3D Timing on page 51.

## On Screen Messages

- Power off confirm

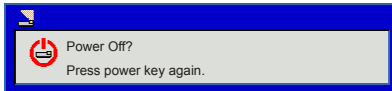

- Fan lock error

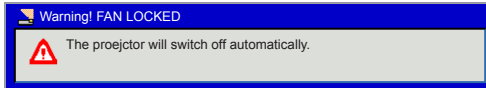

- No source found

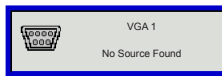

Please refer Troubleshooting on page43.

- Out of display range

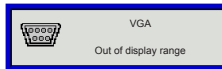

Please refer Compatibility Mode on page48.

- Over temperature

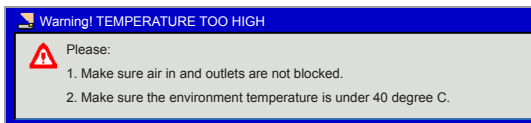



# Compatibility Modes

- VGA Analog
  - PC signal

Modes	Resolution	V. Frequency [Hz]	H. Frequency [Hz]
VGA	640x480	60	31.5
	640x480	67	35.0
	640x480	72	37.9
	640x480	75	37.5
	640x480	85	43.3
	640x480	120	61.9
IBM	720x400	70	31.5
SVGA	800x600	56	35.1
	800x600	60	37.9
	800x600	72	48.1
	800x600	75	46.9
	800x600	85	53.7
	800x600	120	77.4
Apple, MAC II	832x624	75	49.1
XGA	1024x768	60	48.4
	1024x768	70	56.5
	1024x768	75	60.0
	1024x768	85	68.7
	1024x768	120	99.0
Apple, MAC II	1152x870	75	68.7
SXGA	1280x1024	60	64.0
	1280x1024	72	77.0
	1280x1024	75	80.0
QuadVGA	1280x960	60	60.0
	1280x960	75	75.2
SXGA+	1400x1050	60	65.3
UXGA	1600x1200	60	75.0

- Extended wide timing

Modes	Resolution	V. Frequency [Hz]	H. Frequency [Hz]
WXGA	1280x720	60	44.8
	1280x800	60	49.6
	1366x768	60	47.7
	1440x900	60	59.9
WSXGA+	1680x1050	60	65.3

- Component signal

Modes	Resolution	V. Frequency [Hz]	H. Frequency [Hz]
480i	720x480(1440x480)	59.94(29.97)	15.7
576i	720x576(1440x576)	50(25)	15.6
480p	720x480	59.94	31.5
576p	720x576	50	31.3
720p	1280x720	60	45.0
720p	1280x720	50	37.5
1080i	1920x1080	60(30)	33.8
1080i	1920x1080	50(25)	28.1
1080p	1920x1080	23.98/24	27.0
1080p	1920x1080	60	67.5
1080p	1920x1080	50	56.3

- HDMI Digital
  - PC signal

Modes	Resolution	V. Frequency [Hz]	H. Frequency [Hz]
VGA	640x480	60	31.5
	640x480	67	35.0
	640x480	72	37.9
	640x480	75	37.5
	640x480	85	43.3
	640x480	120	61.9
IBM	720x400	70	31.5
SVGA	800x600	56	35.1
	800x600	60	37.9
	800x600	72	48.1
	800x600	75	46.9
	800x600	85	53.7
	800x600	120	77.4
Apple, MAC II	832x624	75	49.1
XGA	1024x768	60	48.4
	1024x768	70	56.5
	1024x768	75	60.0
	1024x768	85	68.7
	1024x768	120	99.0
Apple, MAC II	1152x870	75	68.7
SXGA	1280x1024	60	64.0
	1280x1024	72	77.0
	1280x1024	75	80.0
QuadVGA	1280x960	60	60.0
	1280x960	75	75.2
SXGA+	1400x1050	60	65.3
UXGA	1600x1200	60	75.0

- Extended wide timing

Modes	Resolution	V. Frequency [Hz]	H. Frequency [Hz]
WXGA	1280x720	60	44.8
	1280x800	60	49.6
	1366x768	60	47.7
	1440x900	60	59.9
WSXGA+	1680x1050	60	65.3

- Video signal

Modes	Resolution	V. Frequency [Hz]	H. Frequency [Hz]
480p	640x480	59.94/60	31.5
480i	720x480(1440x480)	59.94(29.97)	15.7
576i	720x576(1440x576)	50(25)	15.6
480p	720x480	59.94	31.5
576p	720x576	50	31.3
720p	1280x720	60	45.0
720p	1280x720	50	37.5
1080i	1920x1080	60(30)	33.8
1080i	1920x1080	50(25)	28.1
1080p	1920x1080	23.98/24	27.0
1080p	1920x1080	60	67.5
1080p	1920x1080	50	56.3

- HDMI 1.4a mandatory 3D timing- Video Signal

Modes	Resolution	V. Frequency [Hz]	H. Frequency [Hz]
Frame Packing	720p	50	31.5
	720p	59.94/60	15.7
	1080p	23.98/24	15.6
Side-by-Side(Half)	1080i	50	31.5
	1080i	59.94/60	31.3
Top and Bottom	720p	50	45.0
	720p	59.94/60	37.5
	1080p	23.98/24	33.8

# Replacing the lamp (Part Number:13080021)

The projector automatically detects the lamp life. When the lamp life is nearing the end of use, you will receive a warning message.

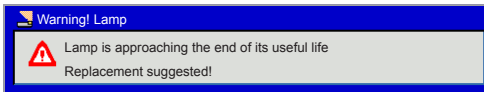

When you see this message, please contact your local reseller or service center to change the lamp as soon as possible. Make sure the projector has been cooled down for at least 60 minutes before changing the lamp.

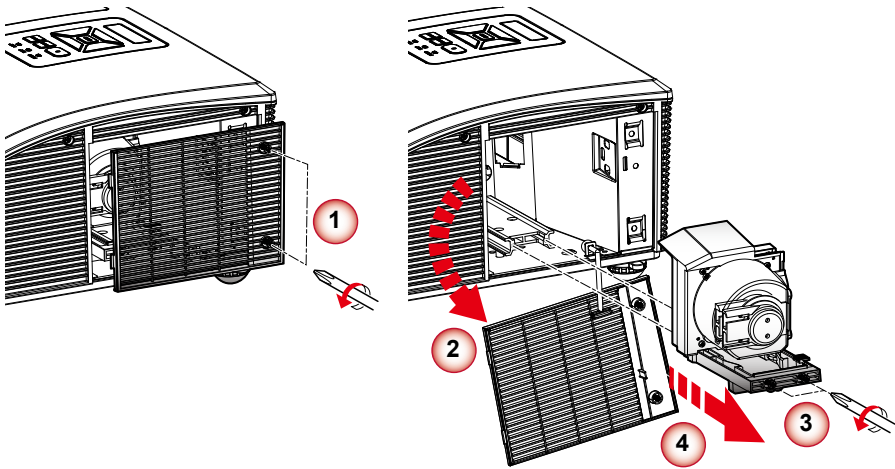

## Note

- The screws on the lamp cover and the lamp cannot be removed.
- The projector cannot be turned on if the lamp cover has not been placed back on the projector.
- Do not touch the glass area of the lamp. Hand oil can cause the lamp to shatter. Use a dry cloth to clean the lamp module if it was accidentally touched.

## Lamp Replacement Procedure:

1. Turn off the projector power by pressing the "⏻" button.
2. Disconnect the power cord.
3. Unscrew the two screws on the cover. ①
4. Lift up and remove the cover. ②
5. Unscrew the two screws on the lamp module. ③
6. Pull up the lamp handle and remove the lamp module slowly and carefully. ④  
<To replace the lamp module, reverse the previous steps.>
7. Turn on the projector and use "Clear lamp hours" after the lamp module is replaced.

## Note

- Please let the projector to cool down for at least 60 minutes.

# Replacing and cleaning the optional dust filter

We recommend cleaning the dust filter after every 500 hours of use, clean it more often if the projector is used in a dusty environment.

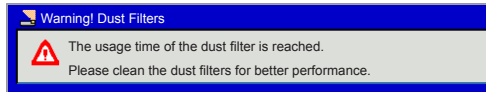

When you see this message, please find following steps for cleaning procedure:

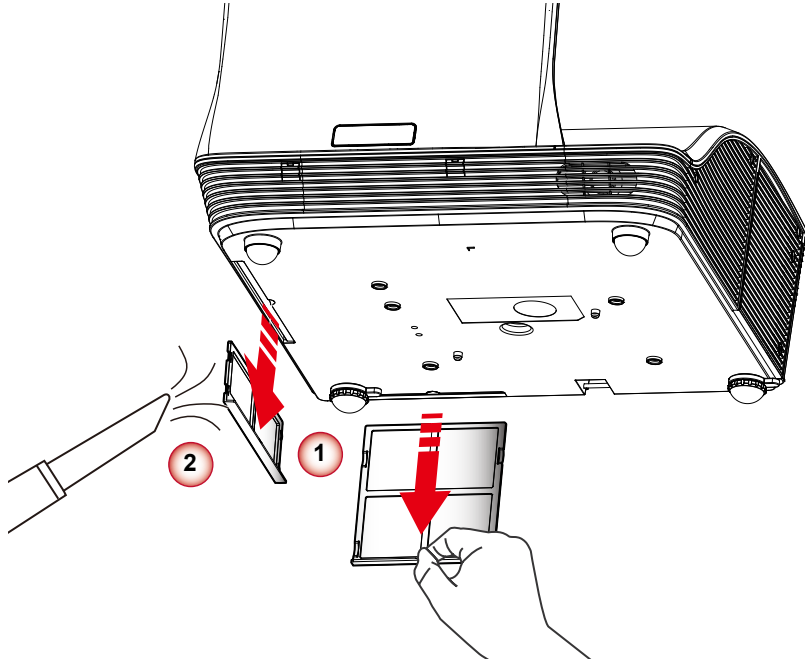

## Note

- The optional dust filter should be used in dusty environments.
- If the dust filter is installed, proper maintenance will prevent overheating and related damage to the projector.

## Cleaning the Dust Filter Procedure:

1. Turn off the projector power by pressing the “**U**” button.
2. Disconnect the power cord.
3. Pull the latch by the arrow direction. ①
4. Remove the dust filter slowly and carefully.
5. Clean or replace the dust filter. ②  
<To install the dust filter, reverse the previous steps.>
6. Turn on the projector and use “Reset Dust Filter” after the dust filter is replaced.

# Ceiling Mount Installation

If you wish to use a third party ceiling mount kit, please ensure the screws which are used to attach a mount to the projector meet the following specifications:

- Screw type: M4x4
  - Diameter: 4 mm
  - Length: 11 mm



■ Please note that damage resulting from incorrect installation will invalidate the warranty.

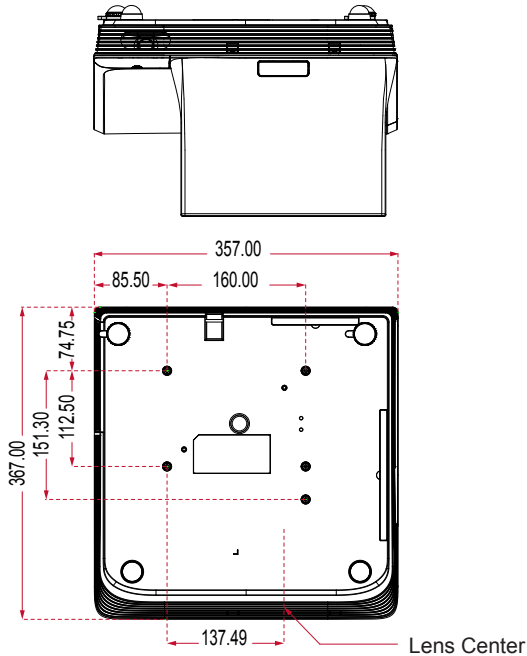

Unit: mm

# Specifications

Projection system	DLP®
Resolution	WXGA (1280x800)
Computer compatibility	IBM PC and compatibles, Apple Macintosh, iMac and VESA standards: SXGA, XGA, SVGA, VGA, WXGA, UXGA
Video compatibility	NTSC (3.58/4.43), PAL (B/D/G/H/I/M/N), SECAM (B/D/G/ K/ K1/L), HDTV (720p, 1080i, 1080p), SDTV (480i, 480p, 576i, 576p)
Aspect ratio	Auto, 4:3, 16:9, 16:10
Displayable colors	1.07 billion colors
Projection lens	F# 2.6
Projection screen size	80.2" - 96.6" (Diagonal)
Max. focus screen size	70" - 100" (Diagonal)
Projection distance	517 mm - 759 mm (±10mm)
Throw ratio	0.35
Horizontal scan rate	30 k - 100 kHz
Vertical refresh scan rate	50 - 120 Hz
Keystone correction	±15 degrees
Weight	8 Kg (17.64 lbs)
Dimensions (W x D x H)	357 (W) x 367 (D) x 135(H) mm (excluding foot) 357 (W) x 367 (D) x 231(H) mm (including reflection mirror)
Power supply	AC 100 - 240 V, 50 - 60 Hz
Power consumption	<ul style="list-style-type: none"> <li>• Normal mode: 350W ±10% @ 110Vac</li> <li>• ECO mode: 290W ±10% @ 110Vac</li> <li>• Standby &lt; 0.5 W</li> </ul>
Operating temperature	5°C to 40°C / 41°F to 104°F



## I/O connectors

- Power socket x 1
- LAN (RJ45) x 1
- RS232 x 1
- DC12V x 1
- HDMI x 1
- VGA input x 2
- VGA output x 1
- S-Video x 1
- Composite x 1
- 3.5 mm audio jack input x 2
- RCA (L/R) audio jack input x 2
- 3.5 mm audio jack input (Microphone)x 1
- 3.5 mm audio jack input x 1
- Mini USB B x 1

## Standard package contents

- AC power cord x 1
- VGA cable x 1
- Remote control x 1
- CR2025 x 1
- Owner's manual (CD) x 1
- Quick start Guide x 1

### **Note**

- *Design and specifications are subject to change without prior notice.*

## Configurations of Terminal

### Analog RGB Input/Output

#### (1) Connections(15P HD-Sub)

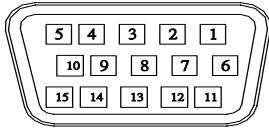

#### (2) Pin Number Define

Pin NO.	Signal Name	Connection
1	R signal Input	R
2	G signal Input	G/Sync. On G
3	B signal Input	B
4	N.C.	N.C.
5	GND	GND
6	R return(GND)	GND
7	G return(GND)	GND
8	B return(GND)	GND
9	N.C.	N.C.
10	N.C.	GND
11	Signal return(GND)	N.C.

#### (3) Connector

- 15P HD-Sub

#### (4) Input signal polarity

- Video signal (RGB): Positive
- Sync: Positive, Negative

#### (5) Input level

- Signal:  $0.7V \pm 0.2V$  p-p 75 $\Omega$  terminate, NRZ
- Sync: TTL

#### (6) Composite Sync.

- TTL: Negative

# HDMI

## (1) Connections

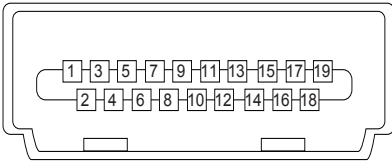

## (2) Pin Number Define

Pin NO.	Signal Name		Signal Name		
1	TMDS Data 2+	9	TMDS Data 0-	17	Ground(DDC/CEC)
2	TMDS Data 2 (Ground)	10	TMDS Clock +	18	+5V POWER
3	TMDS Data 2-	11	TMDS Clock (Ground)	19	Hot plug detect
4	TMDS Data 1+	12	TMDS Clock		
5	TMDS Data 1 (Ground)	13	TMDS Data3+		
6	TMDS Data 1-	14	5V Power		
7	TMDS Data 0+	15	SCL		
8	TMDS Data 0 (Ground)	16	SDA		

## Composite Video Signal

### (1) Connections



### (2) Pin Number Define

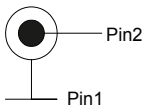

Pin NO.	Signal Name	Connection
1	Video Signal(GND)	GND

(3) Connector: RCA jack

(4) Input signal polarity: Composite signal, Sync: Negative

(5) Input level: Video signal:  $1.0V \pm 0.2V$  p-p  $75\Omega$  terminate, NRZ

## S-Video Signal

### (1) S-Video Connections and Connector

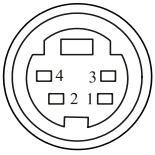

### (2) Pin Number Define

Pin NO.	Signal Name	Connection
1	Y Signal(GND)	GND
2	C Signal(GND)	GND
3	Y Signal Input	Y
4	C Signal Input	C

### (3) Input signal polarity

- Composite signal sync: Negative

### (4)Input level

- Y Signal:1.0V  $\pm$ 0.2V p-p 75 $\Omega$  terminate, NRZ
- Sync:0.286V  $\pm$ 0.1V p-p
- Chromatic:75 $\Omega$  terminate, NRZ
- Burst:0.286V  $\pm$ 20%

## RS232 Control Communication Protocol

Items	Specification
Standard Baud rate	19200 bps
Data length	8 bits
Parity	None
Stop bit	1 bit
Flow Control	None

### RS232 Cable Define

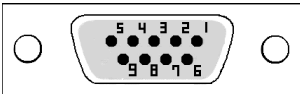

PC Side	Projector side with D-Sub Pin
RX 2	2 RX
TX 3	3 TX
GND 5	5 GND

# EIKI

## U.S.A.

EIKI International, Inc.  
30251 Esperanza  
Rancho Santa Margarita  
CA 92688-2132  
U.S.A.  
Tel: 800-242-3454 (949)-457-0200  
Fax: 800-457-3454 (949)-457-7878  
E-Mail: [usa@eiki.com](mailto:usa@eiki.com)

## Canada

EIKI CANADA - Eiki International, Inc.  
P.O. Box 156, 310 First St. - Unit 2,  
Midland, ON, L4R 4K8, Canada  
Tel: 800-563-3454 (705)-527-4084  
Fax: 800-567-4069 (705)-527-4087  
E-Mail: [canada@eiki.com](mailto:canada@eiki.com)

## Deutschland & Österreich

EIKI Deutschland GmbH  
Am Frauwald 12  
65510 Idstein  
Deutschland  
Tel: +49-6126-9371-0  
Fax: +49-6126-9371-14  
E-Mail: [info@eiki.de](mailto:info@eiki.de)

## Eastern Europe

EIKI CZECH SPOL. s.r.o.  
Nad Cementárnou 1163/4a  
Praha 4, Podolí  
147 00  
Czech Republic  
Tel: +420 241 410 928  
+420 241 403 095  
Fax: +420 241 409 435  
E-Mail: [info@eiki.cz](mailto:info@eiki.cz)

## China

EIKI (Shanghai) Co., Ltd.  
LAKESIDE OASIS MIDDLE RING  
BUSINESS CENTRE  
Block 1, Room 606,  
1628, Jin Sha Jiang Road  
Shanghai, 200333  
CHINA  
Tel: 86-21-3251-3993  
Service Hot line: 86-21-3251-3995  
Fax: 86-21-3251-3997  
E-mail: [info@eiki-china.com](mailto:info@eiki-china.com)

## South East Asia

EIKI Industrial (M) Sdn Bhd  
No. 11, Nouvelle Industrial Park,  
Lorong Teknologi B, Taman Sains Selangor  
1, Kota Damansara PJU5,  
47810 Petaling Jaya, Selangor Darul Ehsan,  
Malaysia  
Tel: +603-6157-9330  
Fax: +603-6157-1320  
E-Mail: [sales@eiki.my](mailto:sales@eiki.my)

## Japan & Worldwide

EIKI Industrial Company Limited.  
6-23 Teramoto, Itami-shi, Hyogo,  
664-0026 JAPAN  
Tel: +81-72-782-9492  
Fax: +81-72-781-5435

**WorldWide Website <http://www.eiki.com>**