



Full Digital Network DSP 5G Wireless Conference System







User Manual

V1.3.6 Version

The meaning of symbols

■ Safety instructions

For your safe and correct use of equipment, we use a lot of symbols on the equipment and in the manuals, demonstrating the risk of body hurt or possible damage to property for the user or others. Indications and their meanings are as follow. Please make sure to correctly understand these instructions before reading the manual.

	This is A level product, which may cause radio interference in the living environment. In this case, users may need to take the feasible measures to get around the interference.
	Remind users that the dangerous voltage without insulation occurring within the equipment may cause people suffer from shock
	CE certification means that the product has reached the directive safety requirements defined by the European Union. Users can be assured about the use of it
	SGS certification means that the product has reached the quality inspection standards proposed by the world's largest SGS.
	This product passed the ISO9001 international quality certification (certification body: TUV Rhineland, Germany).
	Warning: in order to avoid electrical shock, do not open the machine cover, nor is the useless part allowed to be placed in the box. Please contact the qualified service personnel.

■ General information instructions

	It lists the factors leading to the unsuccessful operation or set and the relevant information to pay attention to
---	--

Important note



Warning

In order to ensure the reliable performance of the equipment and the safety of the user, please observe the following matters during the process of installation, use and maintenance:

The matters needing attention of installation

- ◆ Please do not use this product in the following places: the place of dust, soot and electric conductivity dust, corrosive gas, combustible gas; the place exposed to high temperature, condensation, wind and rain; the occasion of vibration and impact . Electric shock, fire, wrong operation can lead to damage and deterioration to the product, either;
- ◆ In processing the screw holes and wiring, make sure that metal scraps and wire head will not fall into the shaft of controller, as it could cause a fire, fault, or incorrect operation;
- ◆ When the installation work is over, it should be assured there is nothing on the ventilated face, including packaging items like dust paper. Otherwise this may cause a fire, fault, incorrect operation for the cooling is not free;
- ◆ Should avoid wiring and inserting cable plug in charged state, otherwise it is easy to cause the shock, or electrical damage;
- ◆ The installation and wiring should be strong and reliable, contact undesirable may lead to false action;
- ◆ For a serious interference in applications, should choose shield cable as the high frequency signal input or output cable, so as to improve the anti-jamming ability of the system.

Attention in the wiring

- ◆ Only after cutting down all external power source, can install, wiring operation begin, or it may cause electric shock or equipment damage;
- ◆ This product grounds by the grounding wires .To avoid electric shocks, grounding wires and the earth

must be linked together. Before the connection of input or output terminal, please make sure this product is correctly grounded;

- ◆ Immediately remove all other things after the wiring installation. Please cover the terminals of the products cover before electrification so as to avoid cause electric shock.

Matters needing attention during operation and maintenance

- ◆ Please do not touch terminals in a current state, or it may cause a shock, incorrect operation;
 - ◆ Please do cleaning and terminal tighten work after turning off the power supply. These operations can lead to electric shock in a current state;
 - ◆ Please do the connection or dismantle work of the communication signal cable , the expansion module cable or control unit cable after turning off the power supply, or it may cause damage to the equipment, incorrect operation;
 - ◆ Please do not dismantle the equipment, avoid damaging the internal electrical component;
 - ◆ Should be sure to read the manual, fully confirm the safety, only after that can do program changes, commissioning, start and stop operation;
- #### Matters needing attention in discarding product
- ◆ Electrolytic explosion: the burning of electrolytic capacitor on circuit boards may lead to explosion;
 - ◆ Please collect and process according to the classification, do not put into life garbage;
 - ◆ Please process it as industrial waste, or according to the local environmental protection regulations.



Version

Version	Update	Date
1.3	2.2 Extension Main Unit 2.4 Connection Box 5.7 CONTROL 6.1.5 Camera Setup & Example 28	2017.1.18
1.3.1	6.1.2 Zone Setup	2017.2.6
1.3.2	5.3 Audio outputs	2017.2.7
1.3.3	6.1.5 Camera Setup & Example 28(Change the flow diagram)	2017.3.11
1.3.4	Add WIFI model, flush model	2017.6.21
1.3.5	6.3Configure the AP 7.5 Default setting	2017.6.27
1.3.6	Update manual for AP	2020.4.8



Content

1. About this manual	6
Safety Instructions.....	6
2. System Overview	7
2.1 Full Digital Networked DSP Processor E-DCP2000	8
2.2 Extension Main Unit E-EXM.....	9
2.3 2.4/5GHz Conference Access Point E-AP4C.....	10
2.4 Splitter Box E-CNB	11
2.5 EWCS Digital Networked Delegate/Chairman Unit-Table models	12
2.6 EWCS Modular Flush-mounting models.....	Error! Bookmark not defined.
3. System Design and Plan.....	17
4. Installation.....	18
4.1 Install in the 19'rack	18
4.2 Install in the AP.....	19
4.3 Install in the Flush unit.....	20
5. Connection	21
5.1 Power supply.....	21
5.2 Audio inputs	21
5.3 Audio outputs	22
5.4 Audio Link	22
5.5 CU/DU	23
5.6 AP.....	26
5.7 CONTROL.....	26
5.8 KEYBOARD	27
5.9 ETHERNET	28
6. Configuration.....	28
6.1 Configuration on the E-DCP2000-W	28
6.1.1 Setup DSP	32
6.1.2 Zone Setup	33
6.1.3 Delegate Setup	35
6.1.4 Interpretation Setup.....	36
6.1.5 Camera Auto-tracking Setup & Application	37
6.1.6 Network Setup.....	41
6.1.7 Configuration Setup	41
6.1.8 WIFI communication setup.....	42
6.1.9 'Default' setting.....	42
6.2 Configuration on the contribution units	43
6.2.1 Set the ID for the delegate/chairman unit.....	43
6.2.2 Set the unit type.....	43
6.3 configure the AP band.....	44
6.3.1 connection.....	44
6.3.2 change the IP segment of the computer.....	45



6.3.3 computer login to AP	46
6.4 Configure the AP E-AP4C.....	48
6.4.1 Set up host SSID and Password	48
6.4.2Set up AP SSID and Password	51
7. Operation.....	53
7.1 E-DCP2000 conference processor	53
7.3 Simple interpreter desk E-DIC-T	54
7.4 Chairman unit and delegate unit display and operation	55
7.5 Default Setting On E-DCP2000-W, E-AP4C and E-WDC-T/E-WDD-T	55
8. shakedown test.....	57



1. About manual

This manual introduce about the conference system family, how to use and install it in the common way and how to control it in commands. We insist you reading the **SAFETY INSTRUCTIONS** and **QUICK START** before using it. In most of our user manual, we are putting important note, instructions and hints in frames of different color, please pay attention to those symbols.

NOTE: Those information is the supplementary explanation to the contents, usage or glossary

CAUTION: Avoid improper operations to damage the product or third party devices connecting

Safety Instructions

Avoid plug in power connector with power on, otherwise will lead to electric shock, or cause damage to the circuit

Installation and wiring must be solid and reliable, otherwise it may result in malfunction on device.

Make sure the device has been well connected to the ground before using

Do not touch the terminals while power on, or may cause electric shock, malfunctions

Do not disassemble the equipment without permission, to avoid damage to the internal electrical components and will void the warranty.

The user manual give the installers and operators the guide to install, configure and operate the EWCS (EIKI WIRELESS CONFERENCE SYSTEM).

Date: 5 September 2016

Copyright: Electronics Limited.

2. System Overview

The EWCS is based on the AUDIO-LINK™ audio distribution & processing technology and Wi-Fi 2.4G/5G Hz technology. The system is combined with wired CAT5 and wireless units and can be used for voting and PC software control.

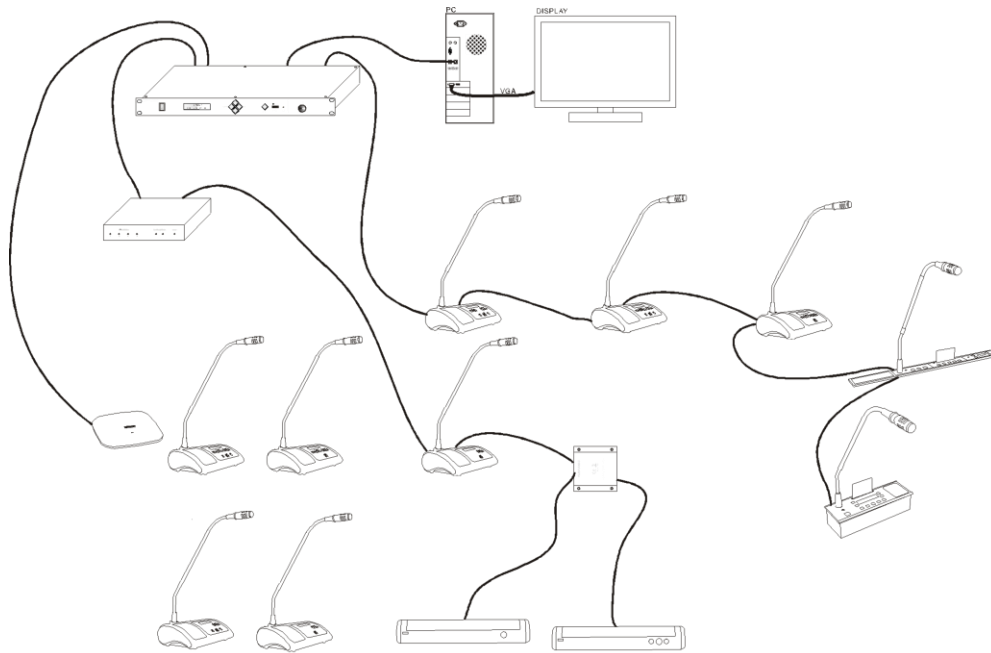

Figure 2.1 WCS system overview

The EWCS system comprises:

- ✓ Full Digital Networked DSP Processor E-DCP2000
- ✓ Extension Main Unit E-EXM
- ✓ 2.4GHz/5GHz Conference Access Point E-AP4C
- ✓ Splitter Box E-CNB
- ✓ Digital Array Microphone with channels selector Chairman/Delegate Unit E-ACC-T/E-ACD-T
- ✓ Digital Array Microphone Chairman/Delegate Unit E-DAC-T/E-DAD-T
- ✓ CAT5 Digital Discussion Chairman/Delegate Unit E-DCC-T/E-DCD-T
- ✓ CAT5 Digital Voting Chairman/Delegate Unit with Channel Selector E-DVC-T/E-DVD-T
- ✓ CAT5 Dual Channels Chairman/Delegate Unit E-DSC-T/E-DSD-T
- ✓ CAT5 Digital Flush-mounting Discussion Chairman/Delegate Unit E-DCC-F/E-DCD-F and E-DCC"-FS"/E-DCD"-FS"
- ✓ CAT5 Digital Flush-mounting 64 Channels Selector Unit E-CSU-F
- ✓ CAT5 Digital Conference System Flush-mounting Voting Unit E-DVU"-FS"1 and E-DVU"-FS"2
- ✓ Flush-mounting Speaker Unit E-SPK-F



- ✓ Flush-mounting Chairman/Delegate Unit with Voting and Channel Selector E-FFC-F1/E-FFD-F1 and E-FFC-F2/E-FFD-F2
- ✓ Wireless Digital Discussion Chairman/Delegate Unit E-WDC-T/E-WDD-T
- ✓ Wireless Digital Voting Chairman/Delegate Unit E-WVC-T/E-WVD-T

2.1 Full Digital Networked DSP Processor E-DCP2000

This processor control all the units in the chain, and supply power to all. You can configure it by the button on front panel with screen information.

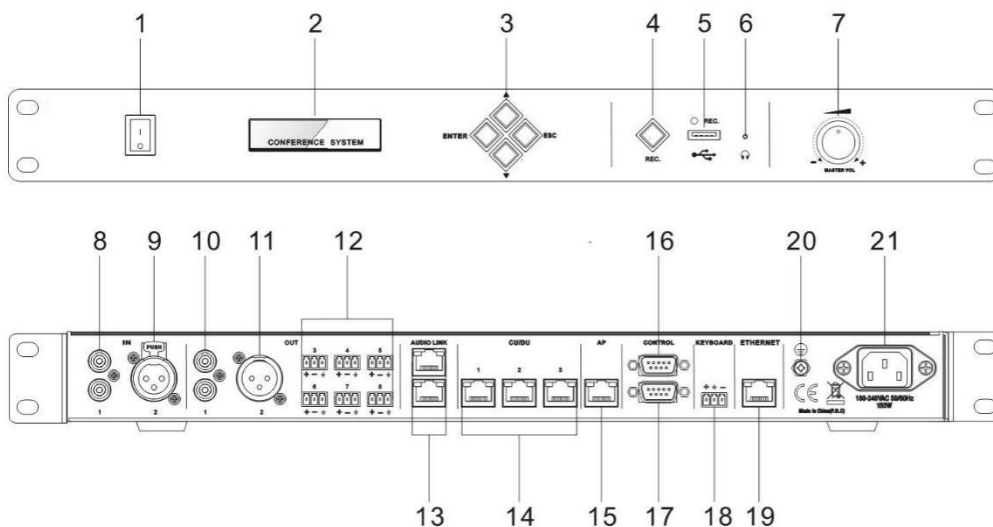

Figure 2.2 Front and rear view of E-DCP2000

On front panel, the processor unit contains:

1. **Power Switch**- Power on or off the processor unit
2. **Display**- Show the current status or the result of your operation, menu list etc.
3. **Operate Buttons**- 4-direction buttons for menu operation, confirm and exit
4. **Audio Recording**- Press to start/stop recording the audio of whole conference content
5. **USB Slot**- To insert USB disk (Up to 32G) for recording, with status light indicator which is flashing during the recording.
6. **Headphone Socket**- Headphone connection
7. **Knob**- Control volume level of the system

On rear panel, the processor unit contains:

8. **Audio Inputs(IN 1)**- RCA audio input from external audio sources like MP3
9. **Audio Inputs(IN 2)**- XLR audio input from external audio sources like Microphone and remote audio input
10. **Audio Outputs (OUT 1)** - RCA audio output to external audio devices like PA system, loudspeakers etc. and can be set as zone output.



11. **Audio Outputs**- XLR audio output to external audio devices like PA system, loudspeakers etc. and can be set as zone output.
12. **Audio Outputs (OUT3, OUT4, OUT5, OUT6, OUT7, OUT8)** - Phoenix audio output. OUT3, OUT4 can be set as zone output. OUT4 also can be set as echo cancellation remote audio output. OUT5, OUT6, OUT7, OUT8 is corresponding to the interpretation CH 1, CH2, CH3, CH4.
13. **Audio Link**-Extend to the next processor for conference room combination and audio exchange.
14. **CU/DU**-Connect to the delegate unit, chairman unit and interpreter unit. The chain 1 and chain 2 or chain 2 and chain 3 can be the closed loop.
15. **AP**- connect to 2.4GHz/5GHz Professional Conference Access PointE-AP4C
16. **Control**-Female DP9 connector is used to connect with camera auto-tracking processor or control system
17. **Control**-Male DP9 connector is used to connect with the camera chains.
18. **Keyboard**-Connect to the camera control keyboard
19. **Ethernet**-Connect to PC or switch for the software control
20. **Ground screw**-Connect the processor unit to the ground
21. **Power inlet**-Connect the processor unit to the main power supply with a power cable.

2.2 Extension Main Unit E-EXM

The extension main unit is used to extend the system to connect more delegate/chairman units.

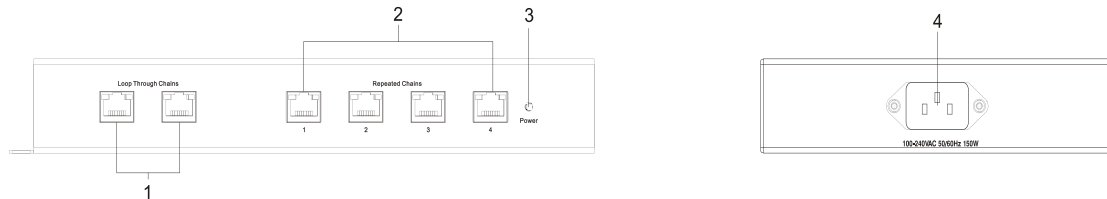

Figure 2.3 Front and side view of E-EXM

1. **Loop Through Chains**-Connect with processor unit/last extension unit and next extension unit.
2. **Repeated Chains**-Provide 4 channels for delegate/chairman units.
- 3 **Power indicator**--Indicate status of the power inlet connection.
4. **Power inlet**-- Connect the extension unit with power cable.



2.3 2.4/5GHz Conference Access Point E-AP4C

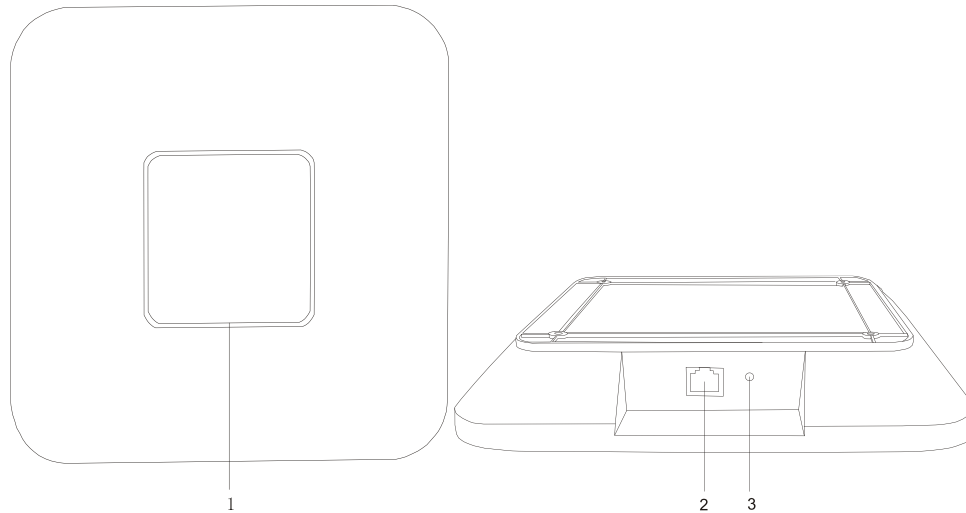

Figure 2.5 Top and front view of E-AP4C

1. Working signal indicator -- When the AP is connected with power, it will be static blue light. When AP is communicating, the indicator is flashing.
2. Network port --connect to the AP port of processor unit or POE switch.
3. Reset button

NOTE: The switch do **NOT** recommend to other devices, only connected with the main unit E-DCP2000 and max. 8 pieces of E-AP4C.



2.4 Splitter Box E-CNB

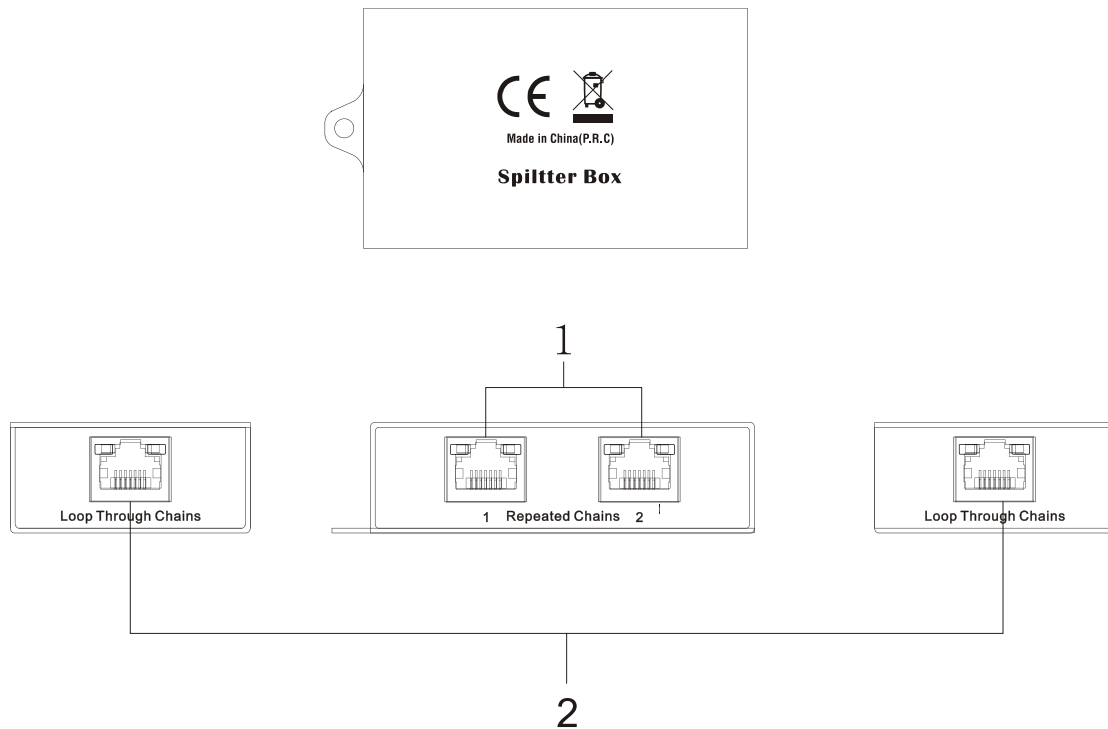

Figure 2.4 Front, rear and top view of E-CBN

1. Repeated Chains -- split two chains for delegate/chairman units
2. Loop Through Chains -- connect to the processor unit, extension unit or loop to next connection box



2.5 WCS Digital Networked Delegate/Chairman Unit-Table models

With the discussion units (wired and wireless), the delegates can make contribution to a conference.

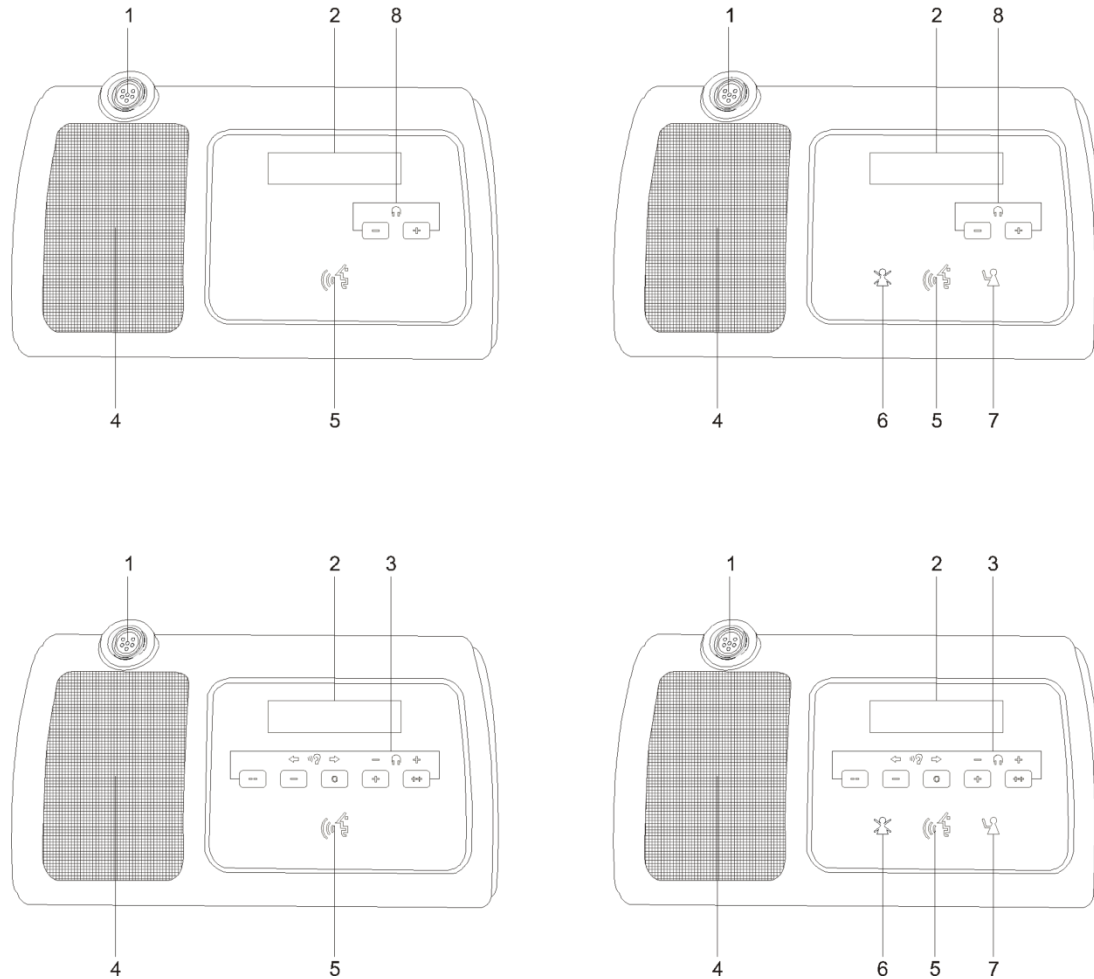

Figure 2.5 Top view of wired and wireless unit (1)

EIKI

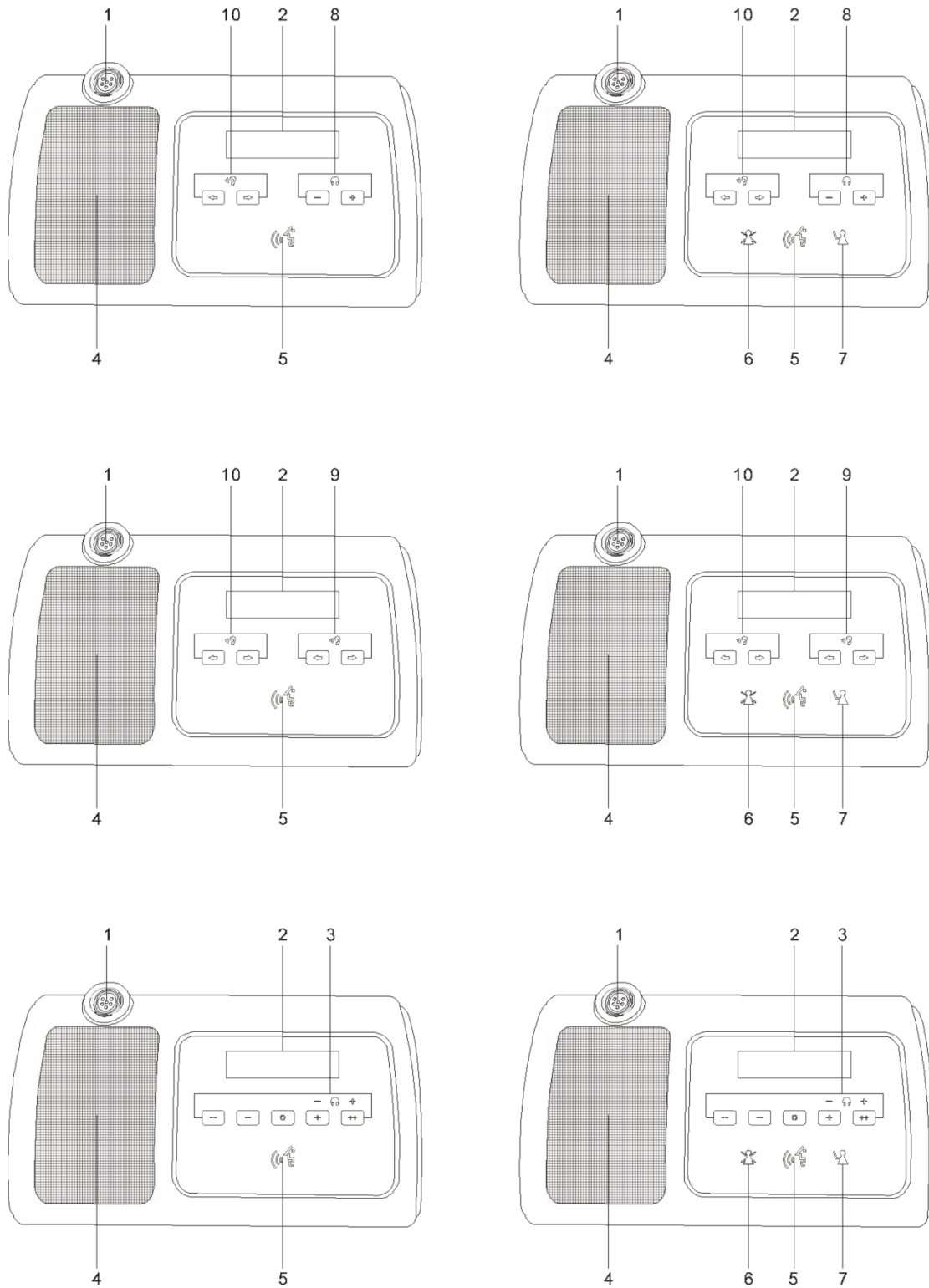

Figure 2.6 Top view of wired and wireless unit (2)

EIKI

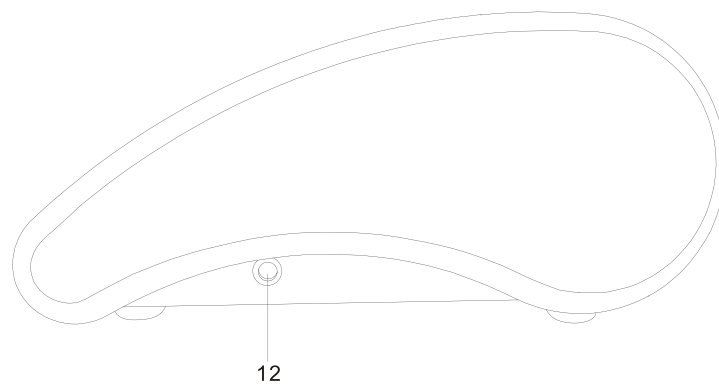
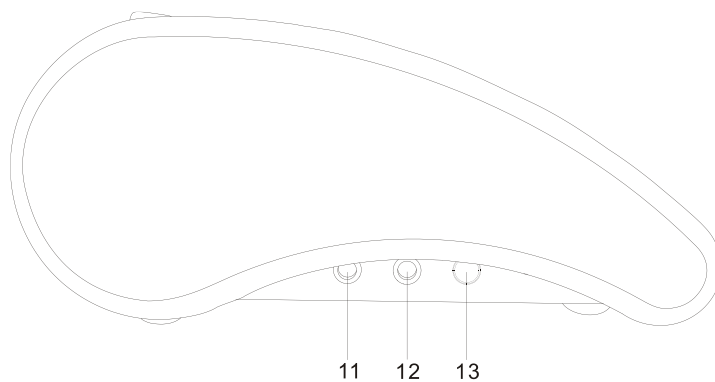

Figure 2.7 Side view of wired or wireless unit

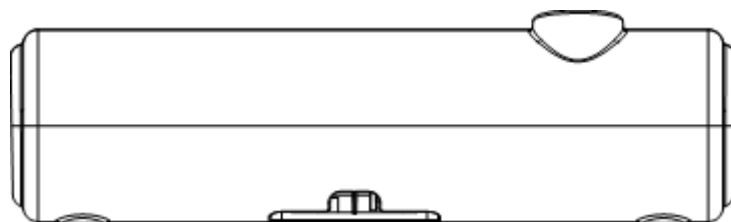

Figure 2.8 Side view of wired unit

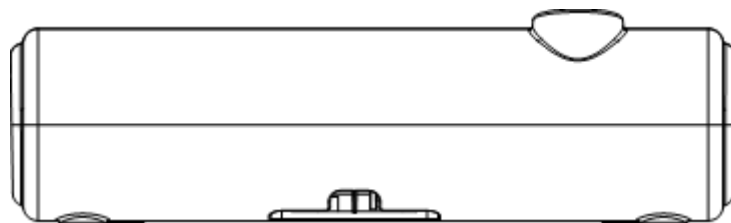

Figure 2.9 Side view of wireless unit

EIKI

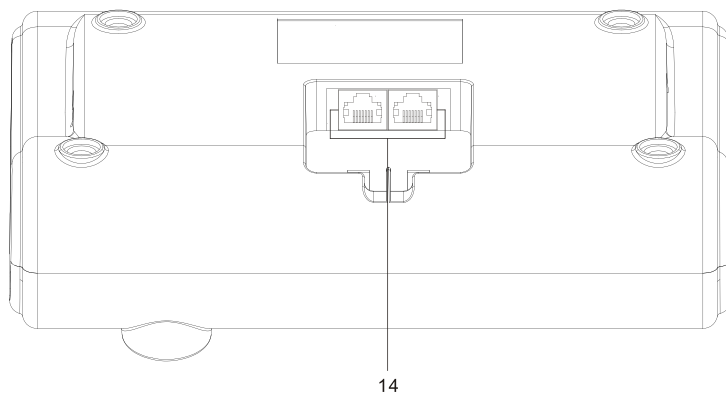

Figure 2.10 Bottom view of wired unit

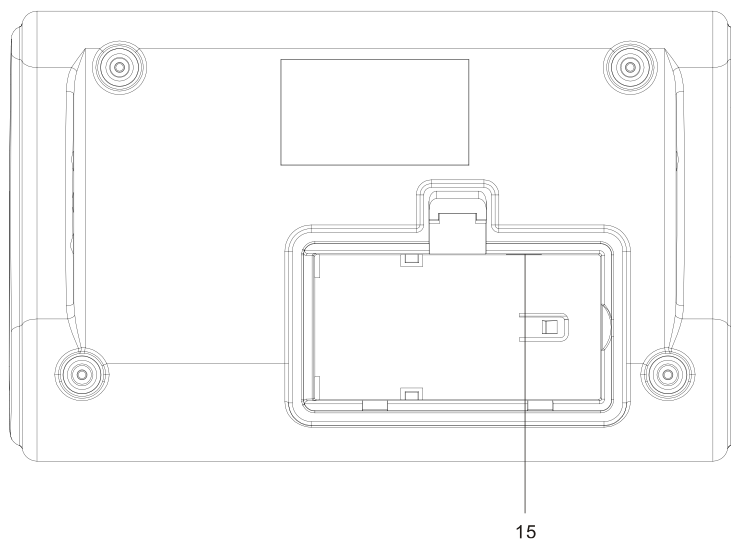

Figure 2.11 Bottom view of wireless unit (1)

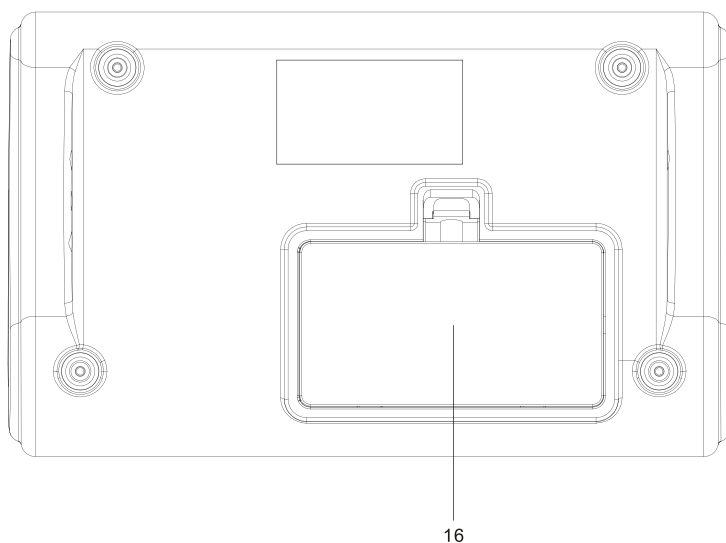

Figure 2.12 Bottom view of wireless unit (2)



1. **Microphone socket**-Connects a pluggable gooseneck microphone (E-M600, E-M410 or E-M330) to the discussion units.
2. **OLED display**-Display the MIC status, volume bar, interpretation channel, voting information, speaking time, clock and date.
3. **5 multi-function keys**- Apply the voting, volume adjustment for headphones, channel selector to select the channel that is sent to the headphone.
4. **Loudspeaker**-Gives the audio signal from the floor to the delegate, when the microphone is enabled, the signal of the loudspeaker is muted.
5. **Microphone button**-Enables or disables the microphone. The microphone button has a LED that shows the condition of the microphone.
6. **Clear button**-clear/deactivate all active delegate microphone or mute the system.
7. **Approval button**-Approve the applying microphone to be enabled under the apply mode and work as mute while pressed clear button.
8. **Volume button**-Adjust the earphone volume.
9. **Right channel selector**-Selects the channel that is sent to the right headphones.
10. **Left channels selector**-Selects the channel that is sent to the left headphones.
11. **Line-in socket**-Connect the microphone, mobile phone or other audio source to impute the audio from the contribution units.
12. **Headphone socket**-Headphone connection.
13. **Power switch**-Power switch for the wireless conference unit.
14. **CU/DU socket**-Makes a loop-through in the WCS system with the discussion unit.
15. **Power supply socket** - Connects a power supply adapter to the wireless discussion unit.
16. **Battery pack compartment** - Contains the battery pack (E-WBTY1) of the wireless Discussion unit.



3. System Design and Plan

Before using our conference system, there are some basic points for you to plan/design a conference room.

The processor control unit is powered by 110V~220V wide range power supply, while it has a basic control capacity (with power relay devices it can load more devices). Here we list a basic capacity of active units for one processor control unit.

Model	Extension cable (m)	E-DCP2000				E-EXM				
		Port 1	Port 2	Port 3	Max. total	Port 1	Port 2	Port 3	Port 4	Max. total
E-DCC-T	0m	30	30	30	90	30	30	30	30	120
E-DCD-T	05m	30	30	30	90	30	30	30	30	120
E-DIC-T	10m	28	28	28	84	28	28	28	28	112
E-DVC-T	20m	24	24	24	72	24	24	24	24	96
E-DVD-T	50m	20	20	20	60	20	20	20	20	80
E-DSC-T	100m	10	10	10	30	10	10	10	10	40
E-DSD-T										

The capacity is decided by:

1. Number of active units in the system
2. Length of extension cable from the first delegate unit to E-DCP2000, or the first unit to the E-EXM

NOTE: Extension cable has direct effect on the control capacity. The longer and extension cable you use, the less power is available to drive the devices connected in the system. You must to choose the length of the extension cable exactly according to the practical situation.



4. Installation

4.1 Install in the 19'rack

The central unit can be installed in a standard 19-inch cabinet. The unit has standard accessories of a pair of installation supports. See the following diagram for installation:

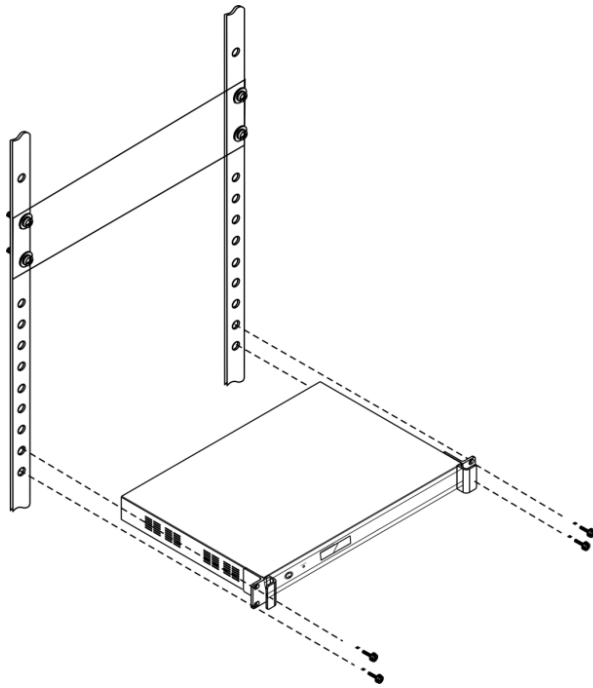



4.2 Install in the AP

The AP need to install in the same room as the MIC units. The AP can be wall-mounted or ceiling installation

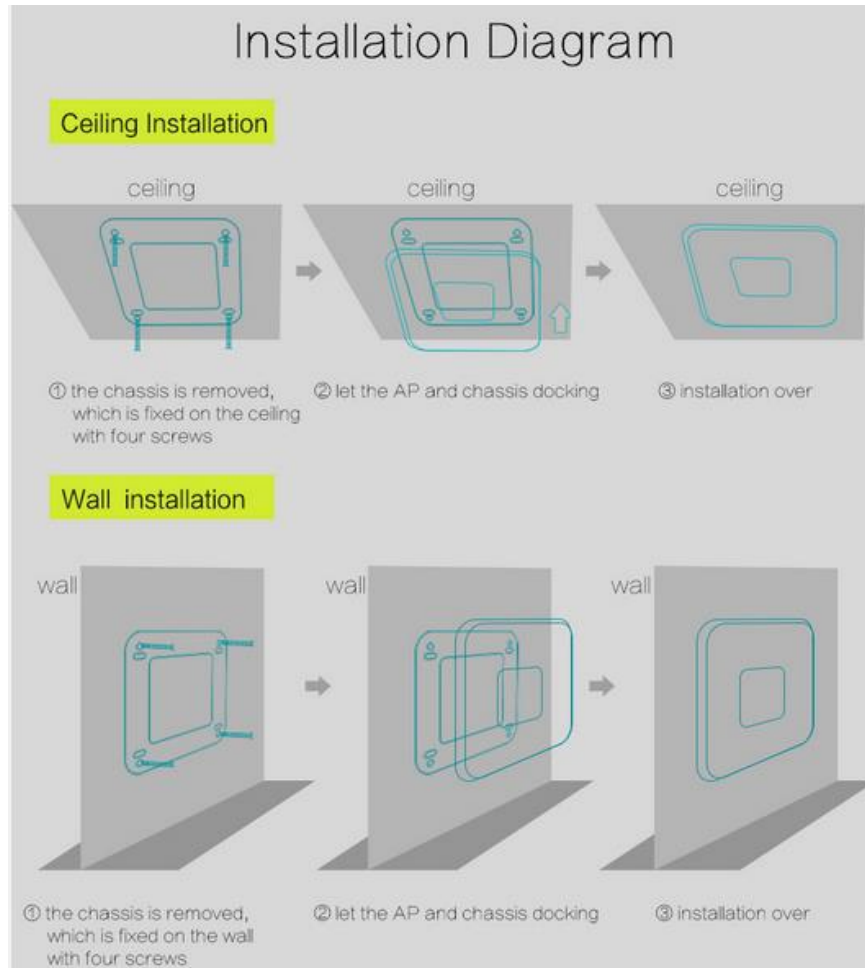

4.3 Install in the Flush unit

Installation steps:

- 1, open the desktop corresponding to the size;
- 2 install the embedded digital conference machine into the opened square hole of desktop;
- 3, install the fixing plate on pressure riveting screw under the machine;
- 4, fix the fixing plate with butterfly nut;
- 5, making M5X35 the butterfly screws go through the fixing plate to lock with desktop, so as to fix the equipment. As below:

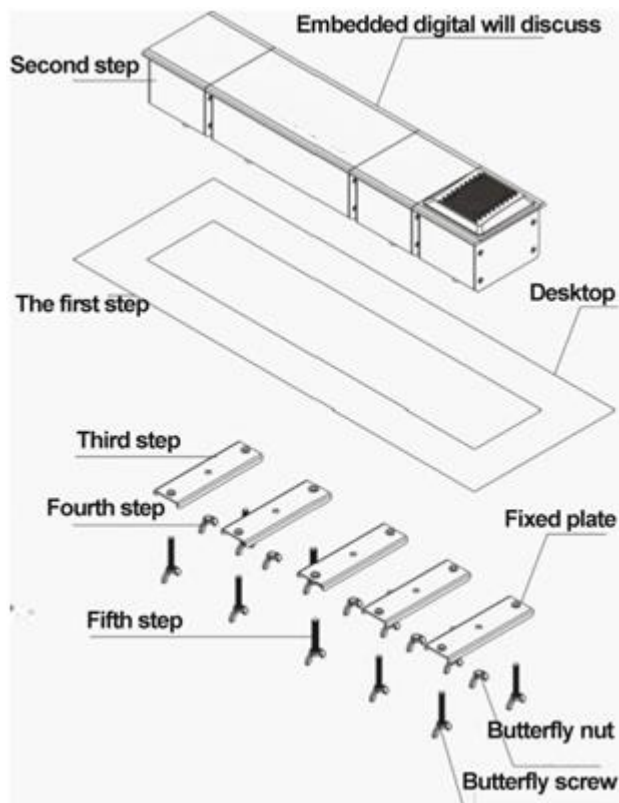

5. Connection

5.1 Power supply

To connect the processor control unit to main power firmly

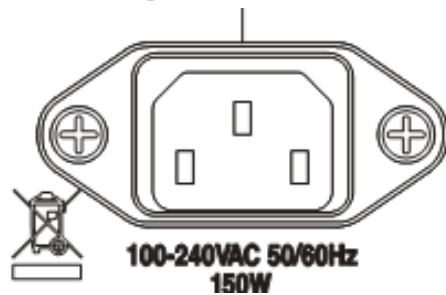

Figure 5.1

CAUTION: Main power supply should well grounded, otherwise it may cause fatal incident

5.2

Audio inputs

The processor control unit provides RCA or XLR type audio input connector.

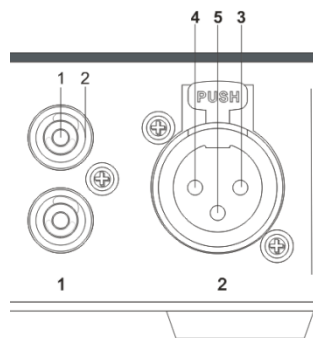

Figure 5.2 Audio input connection

Pin	Type	Signal	Description
1	Cinch	Live	Signal in
2		Return	Shield/Ground
3	XLR	Xternal	Shield/Ground
4		Live	Positive
5		Return	Negative

5.3 Audio outputs

The processor control unit provides RCA, XLR or phoenix type audio output connector

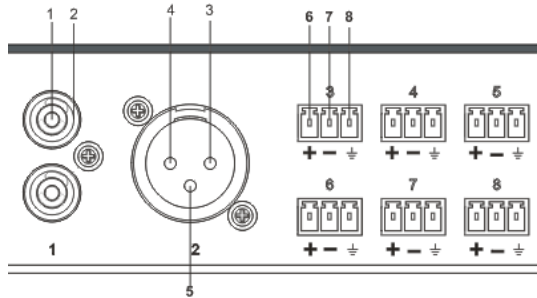
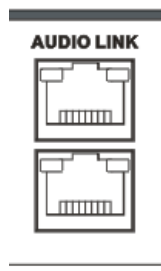

Figure 5.3 Audio output connection

Pin	Type	Signal	Description
1	Cinch	Live	Signal in
2		Return	Shield/Ground
3	XLR	External	Positive
4		Live	Shield/Ground
5		Return	Negative
6	Phoenix	+	Positive
7		-	Negative
8		G	Shield/Ground

5.4 Audio Link



Use audio link socket to connect between the conference processor and use the tested CAT5E cable or better.

EIKI

5.5 CU/DU

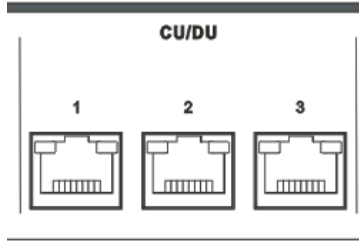

Use the CU/DU socket to connect to the chairman/delegate unit or extension main unit and use the tested CAT5E cable or better.

There are three connection ways available for EWCS conference system.

1. Hand-in-Hand-Loop-Network is an important feature for EWCS conference system. You can use this connection way to make the system steadier.

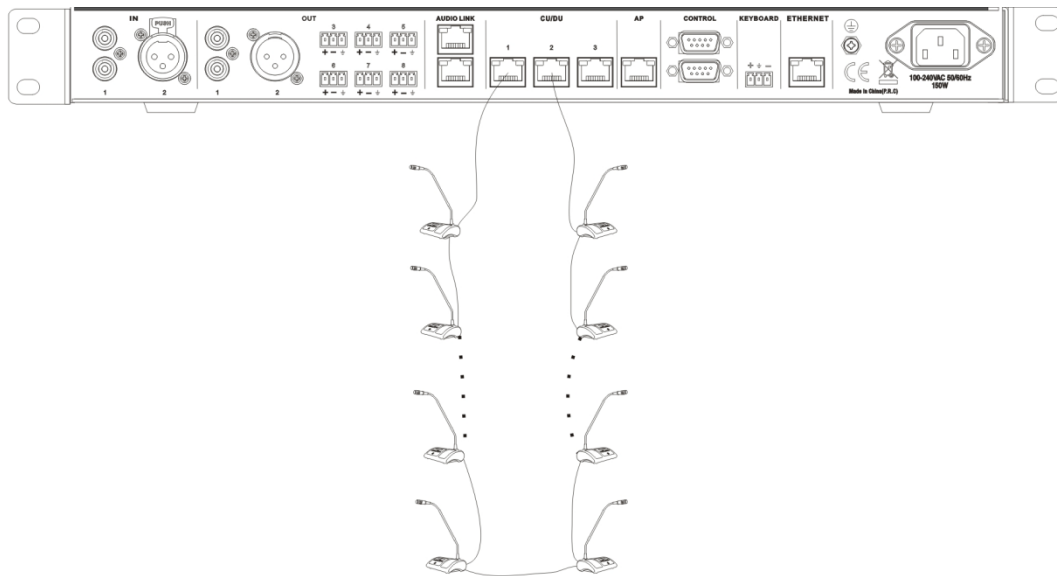

"Hand-in-Hand-Loop-Network" connection is only available between channel 1 and channel 2, or channel 2 and channel 3, but not valid between channel 1 and channel 3.



2. Hand in Hand Connection

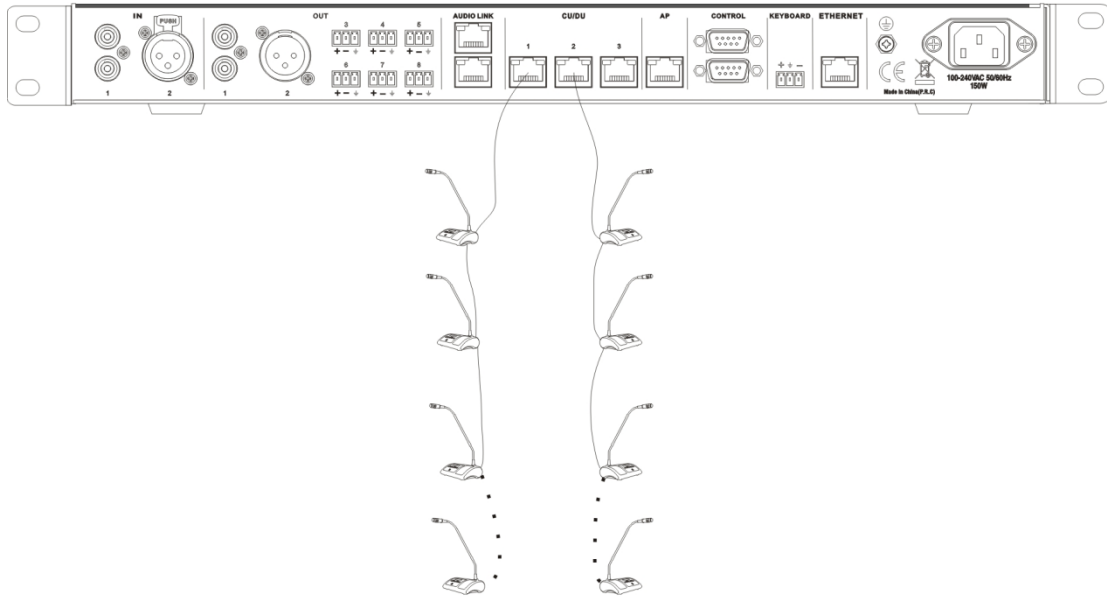

3. Hand in Hand Connection+ Hand-in-Hand-Loop connection

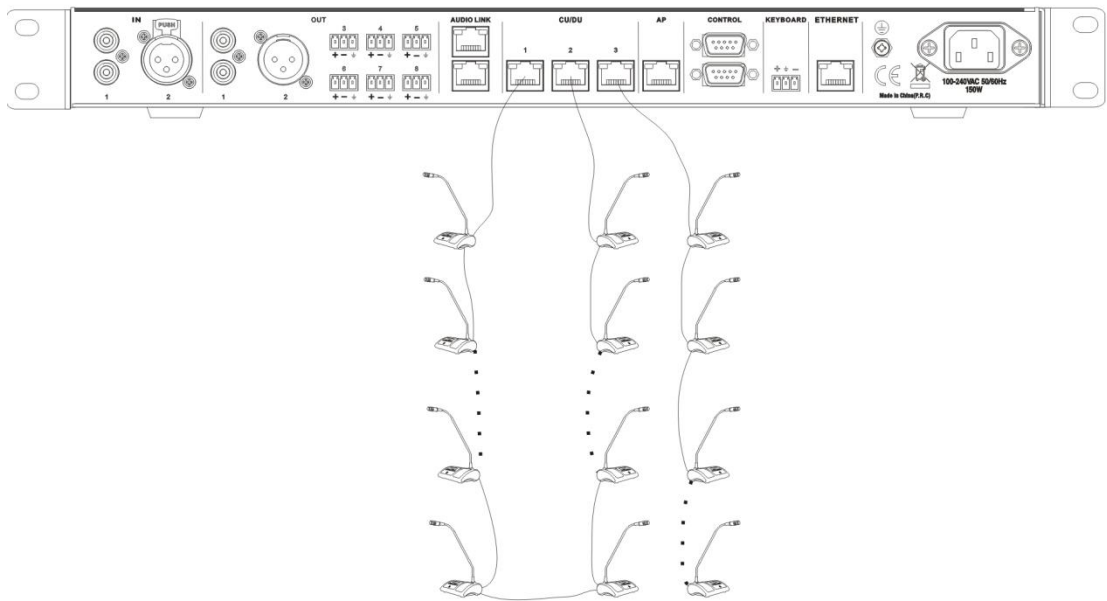



4. Connection box+ Hand-in-Hand-Loop connection

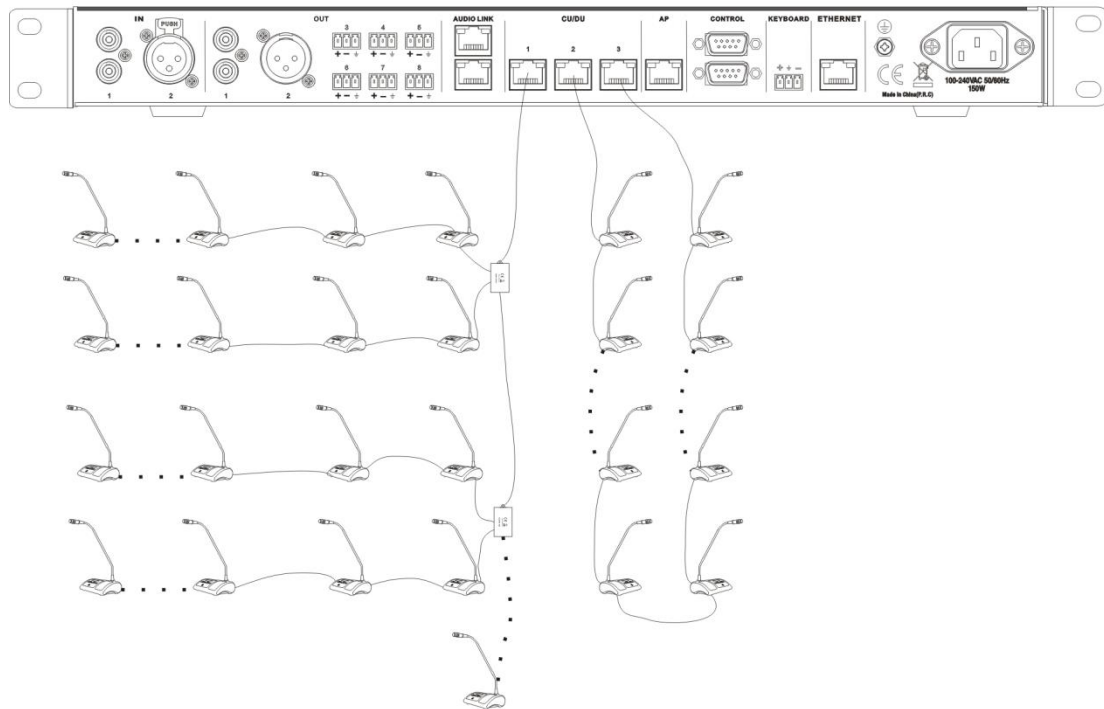

5. Extension Main Unit connection

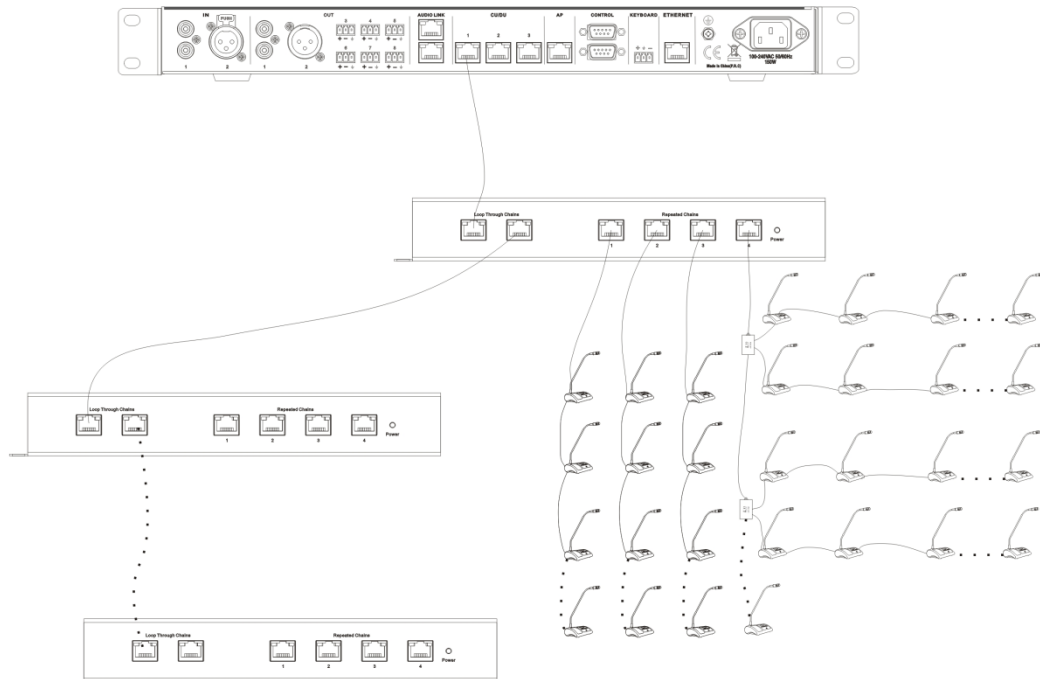

5.6 AP

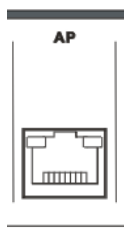

Use the AP socket to connect to the 2.4GHz/5GHz conference access point E-AP4C or switch (connected with E-AP4C) and use the CAT5 cable or better.

NOTE: The switch do **NOT** recommend to other devices, only connected with the main unit E-DCP2000 and max. 8 pieces of E-AP4C.

5.7 CONTROL

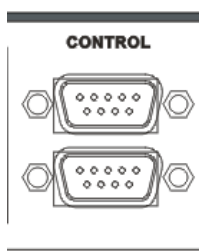

Full digital conference system can use a variety of control systems via RS-232 serial interface. **Upper COM** connected to video switcher/matrix for camera tracking or connect to the central controller

The default switching command is

Baud rate: 9600bps, parity: 8, Stop: 1

Command	Description
1V1.	Switch the channel 1 to output
2V1.	Switch the channel 2to output
3V1.	Switch the channel 3 to output
4V1.	Switch the channel 4 to output
.....
14V1.	Switch the channel 14 to output
15V1.	Switch the channel 15 to output
16V1.	Switch the channel 16 to output



If you need other commands is needed to tell us for update the firmware.

Bottom COM connected to cameras or HD camera auto tracking controller **E-MSDI**.

COM port pin is described as follows:

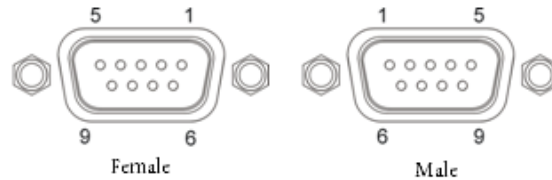

Pin	Signal	Description
1	-	Null
2	TXD	sending data
3	RXD	Receiving data
4	-	Null
5	GND	Signal ground
6	-	Null
7	-	Null
8	-	Null
9	-	Null

5.8 KEYBOARD

KEYBOARD



Use the KEYBOARD socket to connect to the Camera controller with CAT5 cable.



5.9 ETHERNET

ETHERNET

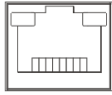

Use the ETHERNET socket to connect to the PC and use CAT5 cable or better.

6. Configuration

6.1 Configuration on the E-DCP2000-W

Use the configuration menu of the processor unit to configure the processor and the system.

Main screen

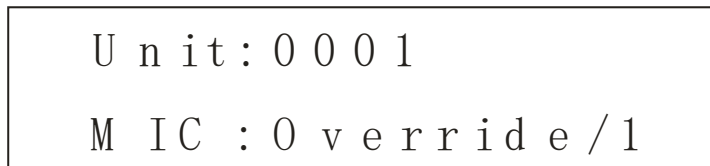

The screen will display as above picture, including the information of total unit quantity '0001' to '4000', MIC mode 'Override, Voice, Open, Apply' and the maximum active number '1, 2,4,6'.

Manu screen

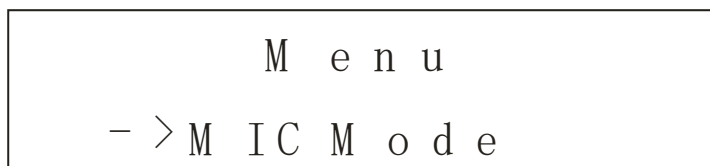

The menu operation buttons '△', '▽', 'ENTER' and 'ESC' is used to browse the menu and set the parameter.

1. Press '△', '▽', 'ENTER' and 'ESC' to browse the menu (as the blue sign)
2. Browse to the green sign menu
3. Press '△', '▽' to adjust parameters and press the 'ENTER' to confirm the options.

The knob 'Master vol' is used to set the volume of master line out and the value directly display on the LCD. You can reference the bellowing menu structure to set the parameters

EIKI

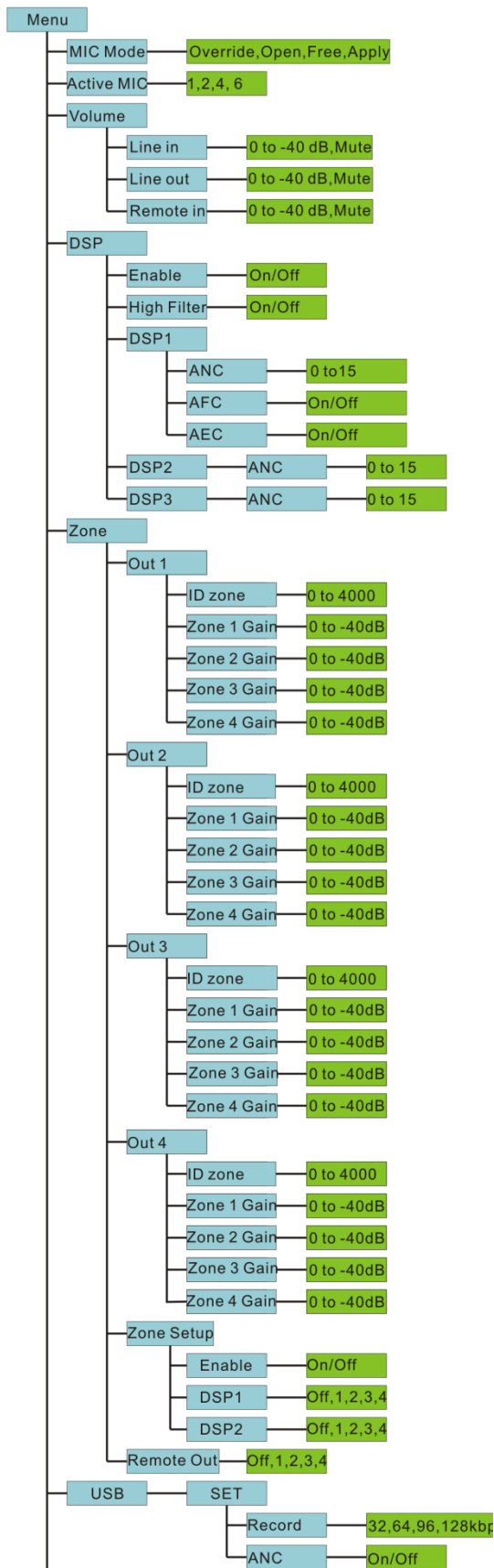

EIKI

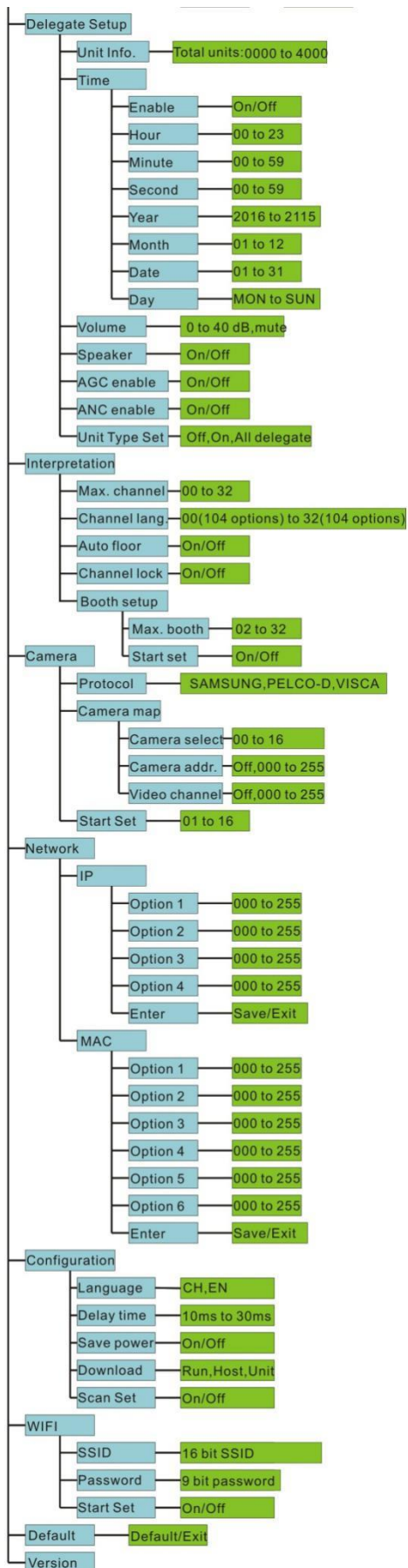



For example, we want to set the active MIC as 3 and operate as bellowing,

1. From the main screen, press the button 'Enter' to get the menu screen as bellowing,

```
      M e n u
- > M I C M o d e
```

2. Press the button '▽'

```
      M e n u
- > A c t i v e M I C
```

3. Press the button 'ENTER'

```
A c t i v e M I C : 1
- > 1   2   4   6
```

4. Press the button '▽' to select the '6'

```
A c t i v e M I C : 1
   1   2   4- > 6
```

5. Press button 'ENTER' to confirm the option and the setting is done.

```
A c t i v e M I C : 6
   1   2   4- > 6
```

6. Press the button 'ESC' back to the main menu.

```
U n i t : 0 0 0 1
M I C : O v e r r i d e / 1
```



6.1.1 Setup DSP

Use the menu items in 'DSP' sub-menu to set to get the sound effect for the whole system.

Menu item	Parameter	Value	Description
Enable	---	On Off	Turn on/off all DSP effect on. If the customers required the original audio quality, ANC, AFC should be off.
HP Filter		On off	Switch on the high-pass filter(low-cut switch) to cut low frequency elements from the audio when needed Switch off the high filter in order to get better sound quality.
DSP1	ANC AFC AEC	0 to 15 On/Off On/Off	1.When switch off the zone audio function(Select under the menu 'Zone'->'Zone Setup'->'Enable'->'off'), DSP1 process the OUT1,OUT2,OUT3,OUT4(output the same audio) 2.When switch on the zone audio function(Select under the menu 'Zone'->'Zone Setup'->'Enable'->'on'),DSP1 process the elect OUT1,OUT2,OUT3 or OUT4(Select under the menu 'Zone'->'Zone Setup'->'DSP1') ANC(Active noise control)-noise reduction level 0 is no reduction and level 15 is the highest reduction. AFC (Acoustic Feedback Cancellation) to prevent or suppress audio feedback. AEC(Acoustic Echo Cancellation),If the AEC is on, the AEC is valid on the channel of the audio input port 'IN 2'as remote sound input and audio output port 'OUT4' as output to remote site.
DSP2	ANC	0 to 15	When switch on the zone audio function(Select under the menu 'Zone'->'Zone Setup'->'Enable'->'on'), DSP2 process the elect OUT1,OUT2,OUT3 or OUT4(Select under the menu 'Zone'->'Zone Setup'->'DSP2') ANC (Active noise control)-noise reduction level 0 is no reduction and level 15 is the highest reduction.
DSP3	ANC	0 to 15	DSP3 reduce the noise on USB audio recording, delegate speaker and delegate headphone. ANC (Active noise control)-noise reduction level 0 is no reduction and level 15 is the highest reduction.



6.1.2 Zone Setup

Use the menu items in 'Zone' sub-menu to set the sound volume for different zone.

The zone function is default value 'off'(menu 'Zone Setup'-> 'Enable'->'off') and the AEC under DSP1 is default value 'off'(Reference menu 'DSP'->'DSP1'->'AEC' description). The audio output 'OUT1', 'OUT2', 'OUT3' and 'OUT4' is output of same audio.

If we need to use the zone function, switch on the zone function'(Menu 'Zone'-> 'Zone Setup'-> 'Enable'->'on'),then we set the other sub-menus under 'Zone'.

Menu item	Parameter	Value	Description
Out 1	ID zone	X1(1~4000)	Out 1 is output the audio to the zone 1. ID zone -set the ID range of MICs in the same zone(zone 1),the the ID start from 1,here we set the number X1 on ID zone and then the ID zone is 1 to X1. Zone 1 Gain -The gain of MICs in Zone1 to OUT1 Zone 2 Gain -The gain of MICs in Zone2 to OUT1 Zone 3 Gain -The gain of MICs in Zone3 to OUT1 Zone 4 Gain -The gain of MICs in Zone4 to OUT1
	Zone 1 Gain	0 to -40dB	
	Zone 2 Gain	0 to -40dB	
	Zone 3 Gain	0 to -40dB	
	Zone 4 Gain	0 to -40dB	
OUT2	ID zone	X2 (X1+1 to 4000)	Out 2 is output the audio to the zone 2. ID zone -set the ID range of MICs in the same zone(zone 2),the default the ID start from X1+1,here we set the number X2 on ID zone and then the ID zone is X1+1 to X2 Zone 1 Gain -The gain of MICs in Zone1 to OUT2 Zone 2 Gain -The gain of MICs in Zone2 to OUT2 Zone 3 Gain -The gain of MICs in Zone3 to OUT2 Zone 4 Gain -The gain of MICs in Zone4 to OUT2
	Zone 1 Gain	0 to -40dB	
	Zone 2 Gain	0 to -40dB	
	Zone 3 Gain	0 to -40dB	
	Zone 4 Gain	0 to -40dB	
OUT3	ID zone	X3 (X2+1 to 4000)	Out 3 is output the audio to the zone 3. ID zone -set the ID range of MICs in the same zone(zone 3),the default the ID start from X2+1,here we set the number X3 on ID zone and then the ID zone is X2+1 to X3 Zone 1 Gain -The gain of MICs in Zone1 to OUT3
	Zone 1 Gain	0 to -40dB	
	Zone 2 Gain	0 to -40dB	
	Zone 3 Gain	0 to -40dB	
	Zone 4 Gain	0 to -40dB	

EIKI

			<p>Zone 2 Gain-The gain of MICs in Zone2 to OUT3</p> <p>Zone 3 Gain-The gain of MICs in Zone3 to OUT3</p> <p>Zone 4 Gain-The gain of MICs in Zone4 to OUT3</p>
OUT4	<p>ID zone</p> <p>Zone 1 Gain</p> <p>Zone 2 Gain</p> <p>Zone 3 Gain</p> <p>Zone 4 Gain</p>	<p>X4 (X3+1 to 4000)</p> <p>0 to -40dB</p> <p>0 to -40dB</p> <p>0 to -40dB</p> <p>0 to -40dB</p>	<p>Out 4 is output the audio to the zone 4.</p> <p>ID zone-set the ID range of MICs in the same zone(zone 4),the default the ID start from X3+1,here we set the number X4 on ID zone and then the ID zone is X3+1 to X4</p> <p>Zone 1 Gain-The gain of MICs in Zone1 to OUT4</p> <p>Zone 2 Gain-The gain of MICs in Zone2 to OUT4</p> <p>Zone 3 Gain-The gain of MICs in Zone3 to OUT4</p> <p>Zone 4 Gain-The gain of MICs in Zone4 to OUT4</p>
Zone Setup	<p>Enable</p> <p>DSP1</p> <p>DSP2</p>	<p>On/off</p> <p>Off,1,2,3,4</p> <p>Off,1,2,3,4</p>	<p>Switch on/off zone audio function</p> <p>When Zone function is valid, select the DSP1 to process the OUT1, OUT2, OUT3, and OUT4 or not process. Don't repeat same output as DSP2.</p> <p>When Zone function is valid, select the DSP2 to process the OUT1, OUT2, OUT3, and OUT4 or not process. Don't repeat same output as DSP1</p>
Remote Out	-	Off,1,2,3,4	<p>It is valid when the zone function is on (Menu 'Zone'-> 'Zone Setup'-> 'Enable'->'on'). Select the IN2 (Remote In) not to output to elect output port (Multi options). For example, select the value '1' and '4', audio output 'OUT1' and 'OUT4' is not mixed the audio from IN2 to output.</p> <p>Note: If DSP (menu DSP->Enable) is on and AEC (menu DSP->DSP1->AEC) is on, OUT4 work as the remote out with the AEC processing.</p>



Application:

Application 1: Change the sensitive of MICs. There are two MICs on the chairman desk, we need to reduce the gain of MICs on the chairman desk. Just change the gain of zone where are MICs on the chairman desk.

Application 2. Increase the sounding gain. There are only MICs on the rostrum, and then we increase the output gain on the auditorium.

USB Recording Setup

Use the menu items in 'Recording' sub-menu to set the recording parameters. 使用菜单

Menu item	Parameter	Value	Description
Set	Quality	32,64,96,128kbps	Set the audio quality of MP3 for
	ANC	On/Off	USB recording

6.1.3 Delegate Setup

Use the menu items in 'Delegate Setup' sub-menu to set the delegate relative setting.

Menu item	Parameter	Value	Description
Unit Info.	Total Units	0000~4000	Show the quantity of delegates/chairman units that connected to the system and help to check the system fault.
Time	Enable	On/Off	Set the time display on the whole system, including the OLED display in the delegate unit. If set the 'Enable' to off, the clock do not display on the delegate unit.
	Hour	00 to 23	
	Minute	00 to 59	
	Second	00 to 59	
	Year	2016 to 2115	
	Month	01 to 12	
	Date	01 to 31	
	Day	MON to SUN	
Volume	-	0 to -40 dB, mute	Set the volume for the speakers and headphone on the delegate units.
Speaker	-	On/Off	Turn on/off the speaker on the delegate units.(not include the interpreter unit)
AGC enable	-	On/Off	
ANC enable	-	On/Off	Reduce the noise for speaker and headphone on delegates.(Note: Any noise reduction technology will affect the audio quality, if customer pursue tone quality, please set off the ANC)
Unit Type Set	-	Off, On, All delegate	Reference to the 6.2.2



6.1.4 Interpretation Setup

Use the menu items in 'Interpretation' sub-menu to set the interpretation relative setting.

Menu item	Parameter	Value	Description
Max. channel	-	00 to 64	Limit the channel number according to the need and reduce the operation on delegate units.
Channel	00 01 ... 64	Chinese, English,...(104 languages) Chinese, English,...(104 languages) Chinese, English,...(104 languages)	Set each Channel to bind with a language.
Auto floor	-	On/Off	On-The interpreter close the MIC on a channel, the audio in this channel is switched to floor audio. Off-The interpreter switch off the MIC and keep the same audio output on the channel.
Channel lock		On/Off	On-The interpreter unit cannot be changed the output channel. Off-The interpreter unit can be changed the output channel.
Booth setup	Max. booth Start set	02 to 64 On/Off	Max. booth--set the booth quantity. On--All interpreter units will show the booth number for options. Press the MIC on interpreter unit to select the booth no. The interpreter units in the same booth should be the same. Off--finish setting. Note: The speakers of the interpreters will be off, if turn on the MIC of interpreter in the same booth



6.1.5 Camera Auto-tracking Setup & Application

Use the menu items in 'Camera' sub-menu to set the Camera auto tracking relative setting.

Menu item	Parameter	Value	Description
Protocol	-	SAMSUNG,PELCO-D,VISCA,CUSTOM	Select the protocol according to the camera model, The value 'CUSTOM' mean the processor connect the camera tracking controller E-MSDI and the preset information is saved on the camera controller and don't need to set the sub-menu ' Camera map ' and 'Start Set'
Camera map (Note: If you use the cameras using SAMSUNG or PELCO-D protocol need to set this menu. Use VISCA protocol, no need to set this menu)	Camera select Camera addr. Video channel	001 to 016 Off,001to 255 Off,001 to 255	Camera select --select the camera to setup, there totally support 16 cameras. Camera addr. --set the camera address for the camera selected on submenu 'Camera select'.(if SAMSUNG,PELCO-D need to set the address, VISCA is not need to set as Off) Video channel --Bind the camera (which set on submenu 'camera select') to the video channel number of video switcher, (There are no video switcher connected to the main unit for camera tracking by RS232, just set as Off.) Note: To set next camera, we just repeat the same steps: 'Camera Select->'Camera addr' ->'Video channel' The main unit will record every times of setup for each cameras.
Start Set	-	01 to 16	Select the camera no.1 to 16 to start the camera tracking setting. Step 1: Select "01" on main unit for no.1 camera Step 2: Adjust the camera to shoot the microphone. Step 3: Press ON and press Off the microphone that camera are shooting Step 4: Adjust the camera to shoot the next microphone. Step 5: Press ON and press Off the microphone that camera are shooting Step 6:Repeat the step 2 to step 5 until you preset all position for the camera '01' Step 7: Select "02" on main unit for no.2 camera Step 8: Repeat the step 2~step 6 to finish the camera '02'. More camera are set as the same way. Step 9: After setting the last microphone (on and off

EIKI

			<p>the MIC), we can adjust the camera to give a full view of the meeting and press 'ESC' to quit from the menu of 'Start Set'. The preset of full view will be active while there are no microphone on.</p> <p>Note: When exit the camera setting, the system will record the final camera position as the full view preset, so we finish the setting of last MICs covered by this camera, we need to adjust the camera to get the full view preset and next to exit the setting of the camera. (You can consider the chairman unit as the full view preset.)</p>
--	--	--	---

Example

Here we need to set up 2 cameras with VISCA, SAMSUNG/ PELCO-D or CUSTOM protocol and switch the video by a video switcher or camera auto-tracking controller E-MSDI

Step 1. Connect the main unit to the cameras or camera auto-tracking controller E-MSDI with the bottom CONTROL port.

1. Use the VISCA protocol camera



2. Use the SAMSUNG/ PELCO-D protocol camera



Step 2. Use CUTOM protocol and camera tracking host to take charge of camera tracking.

We need to connect the 232 of the automatic tracking host or the integrated computer to the upper control port of the CONTROL of the conference processing host.

EIKI

1. RS232 controls HD camera automatic tracking host E-CATC-A.

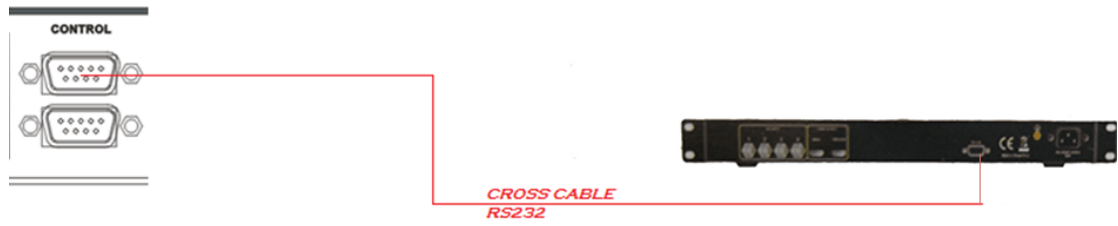

2. RS232 control conference tracking and recording all-in-one machine E-CRS05-A.





Step 3 Set the camera information to the main unit by the front panel and adjust camera to shoot the position by remote controller, keyboard controller or EWCS conference software as the following step flow.

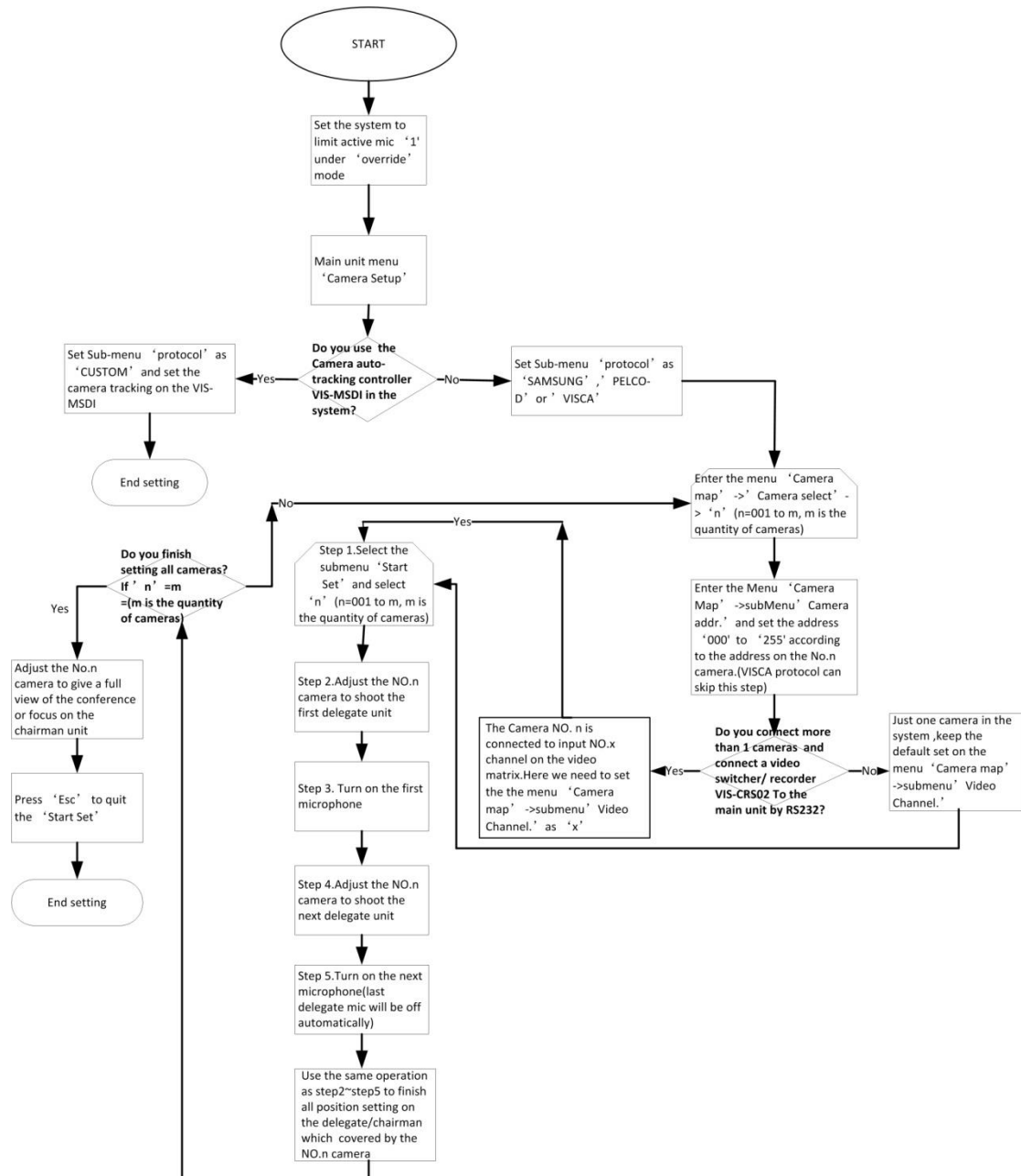



6.1.6 Network Setup

Use the menu items in 'Network' sub-menu to set the IP address and MAC for processor unit.

Menu item	Parameter	Value	Description
IP	Option 1	000 to 255	Set the static IP for the processor. Default IP address:192.168.10.100 Port:10166
	Option 2	000 to 255	
	Option 3	000 to 255	
	Option 4	000 to 255	
	Enter	Save/Exit	
MAC	Option 1	000 to 255	Set the MAC address for the processor. Note: The MAC need to be different in the same local area network.
	Option 2	000 to 255	
	Option 3	000 to 255	
	Option 4	000 to 255	
	Option 5	000 to 255	
	Option 6	000 to 255	
Enter	Save/Exit		

6.17 Configuration Setup

Use the menu items in 'Configuration ' sub-menu to set the parameter for global system.

Menu item	Value	Description
Language	CN/EN	Change the language for main unit and delegate units (Note: We can change the language according to your need by updated the firmware)
Delay time	10ms~30ms	The default setting is 15ms,other options are only for test,
Save power	On/Off	Note: Not ready, plan for system power saving.
Download	Run/Host/Unit	The default setting is 'Run' to keep the system run faster. When we need to update the firmware for the processor, we select 'Host' .When we need to update the firmware for the delegate units, we select 'Unit' (Note: Don't change the default setting 'RUN', Only if you need to update the system.)
Scan Set	On/Off	Default is off, when scan set is on, the system will check the ID of delegate units when boot up, if there are ID conflict, those conflicting MICs will be flashing.



6.1.8 WIFI communication setup

Menu item	Value	Description
SSID	16 bits	16 bits SSID,Default setting is WIFI_CONFERENCE
PASSWORD	9 bits	9 bits password for communication between main unit to the delegate unit, default password is 88888888
Start Set	On/Off	<p>The default setting is OFF.</p> <p>If set as "On", the main unit will send the new SSID and PASSWORD to the wireless delegate/chairman unit. After all delegate/chairman unit is received the new SSID and PASSWORD, please set the 'START SET 'menu as Off.</p> <p>Please reboot the wireless delegate/chairman unit and all wireless unit is not able to connect to the main unit after update the SSID and PASSWORD. Please visit the wireless AP E-AP4C by browser on PC, set the same SSID and PASSWORD on the E-AP4C. After corrective setting, wireless unit and main unit can communicate again.</p>

6.1.9 'Default' setting

For urgent situation or wrong setting on the parameters, the 'Default' setting can set the main unit to the factory default setting.



6.2 Configuration on the contribution units

After connection all the units, we need to set the ID for every contribution units. If there are installed all E-DIC-T, and need to set them as chairman unit, delegate unit, interpreter unit or VIP, we need to set the unit type.

6.2.1 Set the ID for the delegate/chairman unit

The LCD display are working on the main screen.

Main screen

```
U n i t : 0 0 0 1
M I C : O v e r r i d e / 1
```

Press the button 'ESC' around 2 seconds on processor unit, the display will show the ID setting interface.

```
S e t t i n g I D . . .
```

Just press the MIC button on every delegate/chairman units one by one and set the ID for them. Press the button "ESC" around 2 seconds on the processor unit, the display exit from the 'Setting ID...' interface and back to main screen. The setting is saved and finished.

6.2.2 Set the unit type

Enter the menu of 'Delegate Setup' and set on the sub-menu 'Unit Type Set'.

```
D e l e g a t e S e t u p :
U n i t T y p e S e t
```

E-DIC-T is default as the chairman unit and there are most of units are delegate units in a conference system, so we need to set all units as 'All delegates'.

```
T y p e : A l l d e l .
- > A l l d e l e g a t e s
```



Set as the above screen, all the E-DIC-T are worked as the delegate units. Next set the as 'Type: ON.'

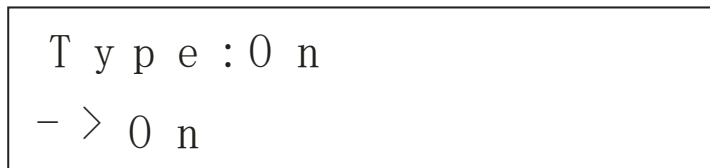

We can check on the contribution units and the display on all units show the bellow screen.



We press the MIC button on the unit and the display will shift cyclically as Delegate-Chairman-interpreter-VIP.Let the them display as what you want to set as.

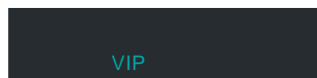
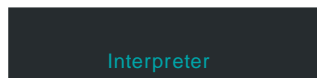
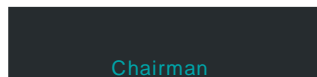

Set on the processor unit to off the type setting as bellowing.

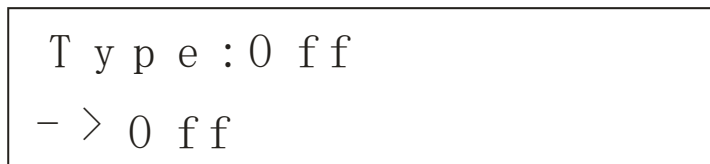

6.3 configure the AP channel

6.3.1 Connection

The site changes the wiring as follows, AP is changed from the AP port to any interface of the CU/DU, and the computer connects the network port of the upper layer of the AUDIO-LINK with the network cable.

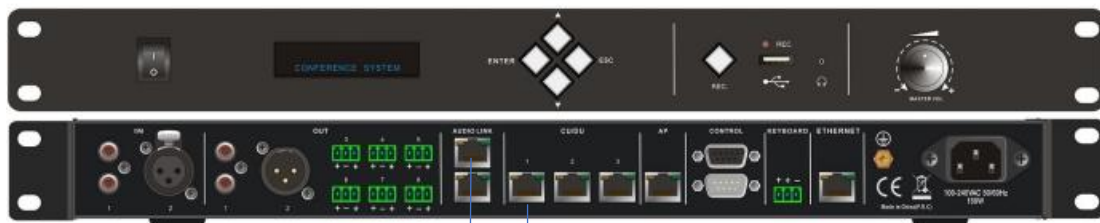

EIKI

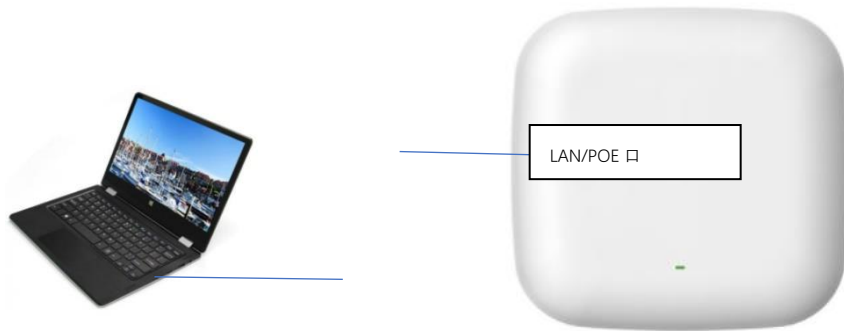

6.3.2 Change the IP segment of the computer

Change the computer IP segment to 2, for example, 192.168.2.200

Open the computer's network and Internet settings to change the adapter options, Ethernet right-click properties click on Internet protocol version 4 (TCP/IPv4), click on the properties below, set the same IP segment address for PC and AP. The default IP address for the For example, the network properties of our PC are shown in the following figure:

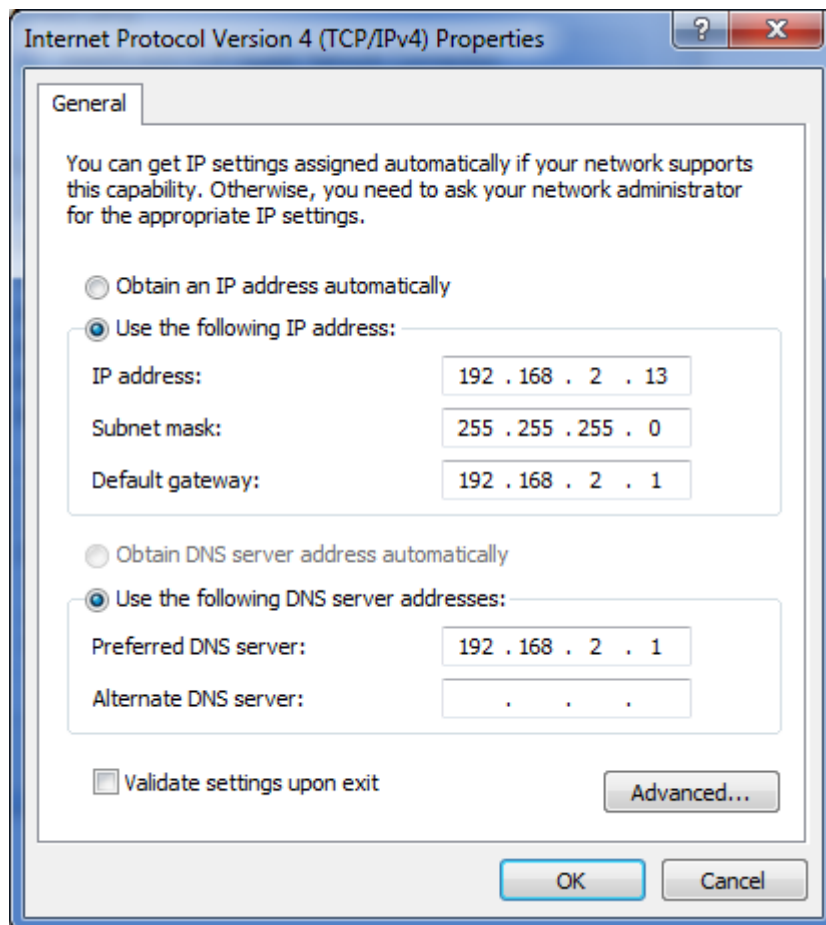



6.3.3 Computer login to AP

1. 192.168.2.1, log on to AP through a computer browser to set up.
2. Enter user name admin, password admin.

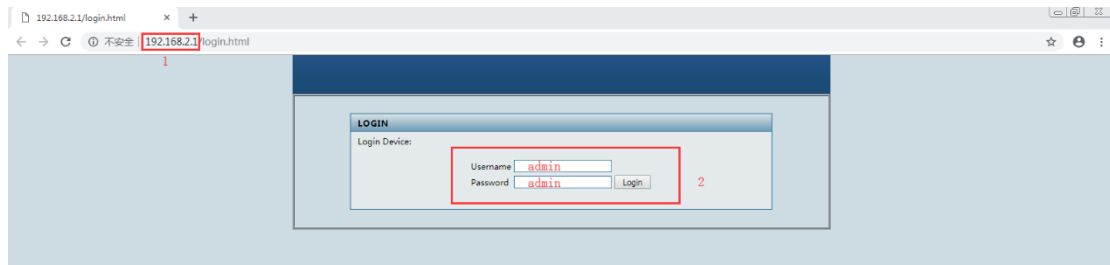

3. After logging in to the main interface, click 5.8G Configuration on the settings navigation menu on the left.
4. Click Setting
5. Click Scan

As shown below

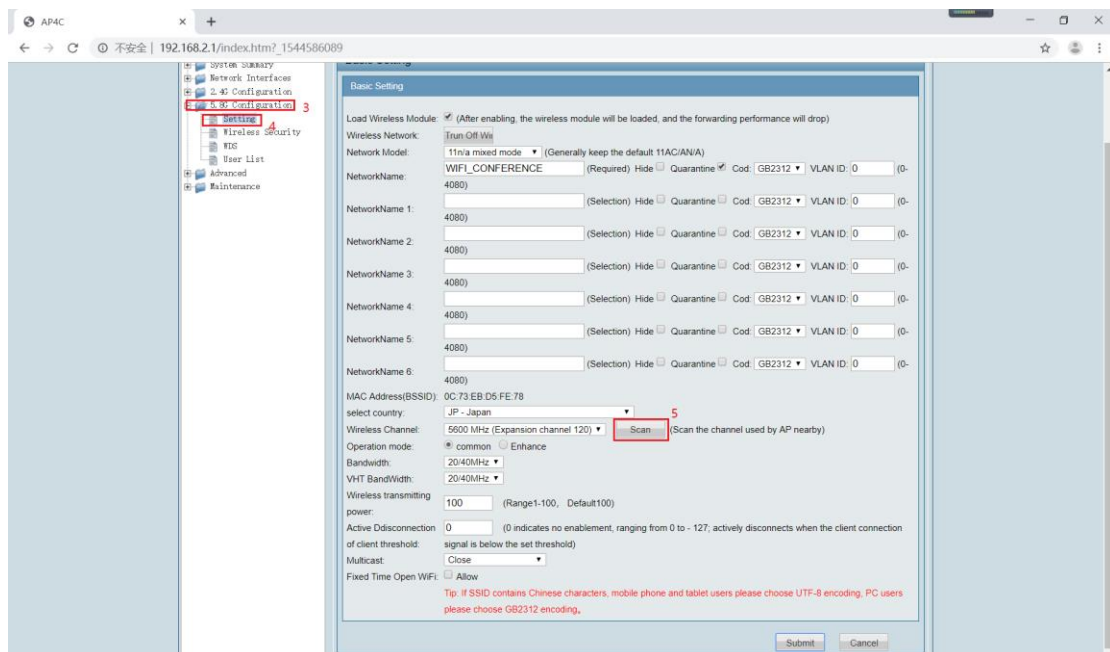

6. Click refresh multiple times to see the 5G signal usage in the field environment. Channel shows the current AP (WiFi_CONFERENCE) occupation channel 48 and other AP occupation 5G channels.

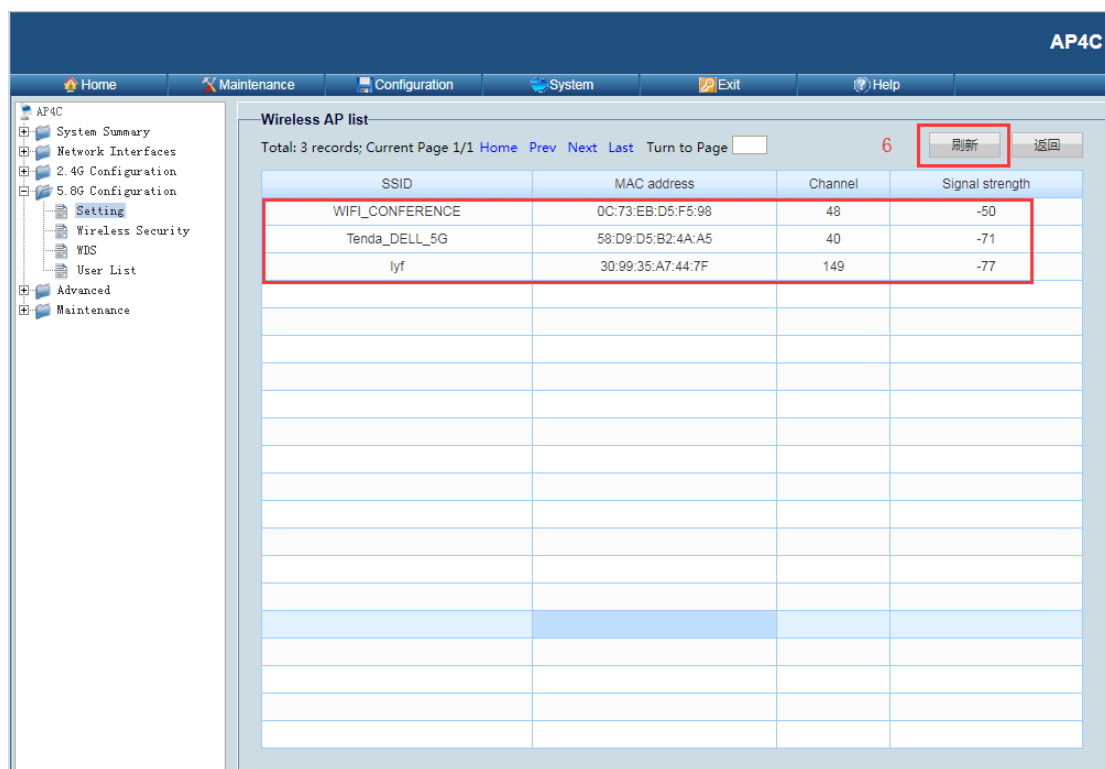

7. Click the return button to select the unused channel, which is currently available between 36 / 48/149 / 165 to select the unoccupied channel.

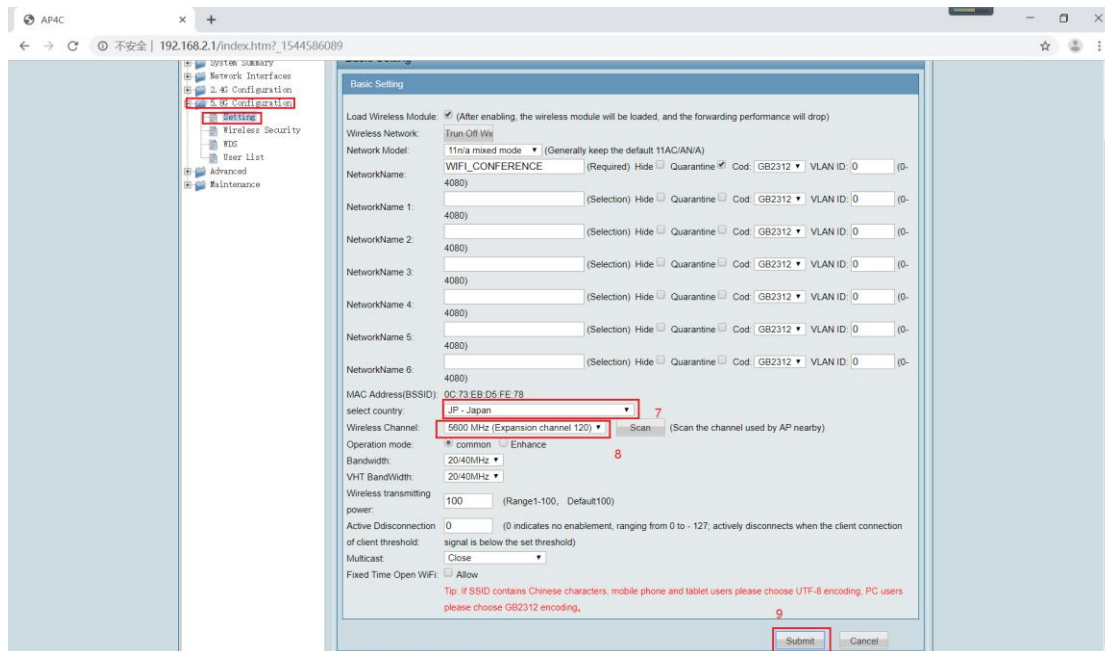

8. When you have selected it, click Submit, to save.

AP is connected back to the AP port of the host and debugging is complete.



6.4 Configure the AP E-AP4C

When multiple wireless conference systems are used in the same building, we need to set up a different SSID. For each conference system.

1. First, change the SSID, through the conference host menu and send it to all units.
2. Log in to the AP and change the SSID of the AP.

6.4.1 Set up host SSID and Password

1. Enter the WIFI menu on the front panel of the conference host LCD, including the submenu SSID, PASSWOPD, Start Set:

Menu item	Parameter/parameter	Describe
SSID	16 bits	16-bit SSID,default is WIFI_CONFERENCE
PASSWORD	9 bits	Communication password between 9-bit host and unit By default:88888888
Start Set	On/Off	Turn off OFF, by default and turn on on. If SSID and PASSWORD, are changed, the SSID and PASSWORD set by the host will be sent to the WIFI wireless unit. When the unit receives the information, it will be updated successfully, and all the units will be updated back to the default off. Please restart the wireless unit manually, the unit will not be able to connect to the upper host after updating the SSID and PASSWORD ,and the corresponding SSID and PASSWORD, and the corresponding SSID and PASSWORD will need to be updated by logging in to the wireless AP E-AP4C,The unit and host meeting will only be re-communicated.

For example, we want to change the SSID to "WIFI_"and the Password to "88888888"



2. The operational steps are as follows:



Step 1 Through the conference host front panel LCD view and menu button operation, press ENTER key to enter the option setting when the Wi-Fi option is displayed, turn down to display SSID,PASSWORD,Start set.



First set the SSID, key to enter the setting to see the network name, press the ▲ or ▼ key to select each character, press the key to select each character, press the ENTER key to select the next character, To determine the name such as "WIFI_", press ESC to return Out, next set the PASSWORD, operation as above, change the password to "88888888" press ESC to exit.



Step 2 Ensure that all the wireless microphone units are in the starting working state, then set the Start set, enter the setting with off and on two options, select the setting as Start set: on, then the main opportunity sends the SSID and PASSWORD set by the step 1to the wireless conference unit, and after the conference unit receives the information, The display displays the "Update succeeded".

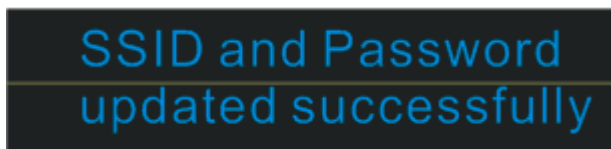

EIKI

Step 3 Shows that after the update is successful, set up the Start set: off, and manually reschedule all microphone units, all units display unable to connect to the host, constantly status, at the AP needs to be updated.



Wireless Connection

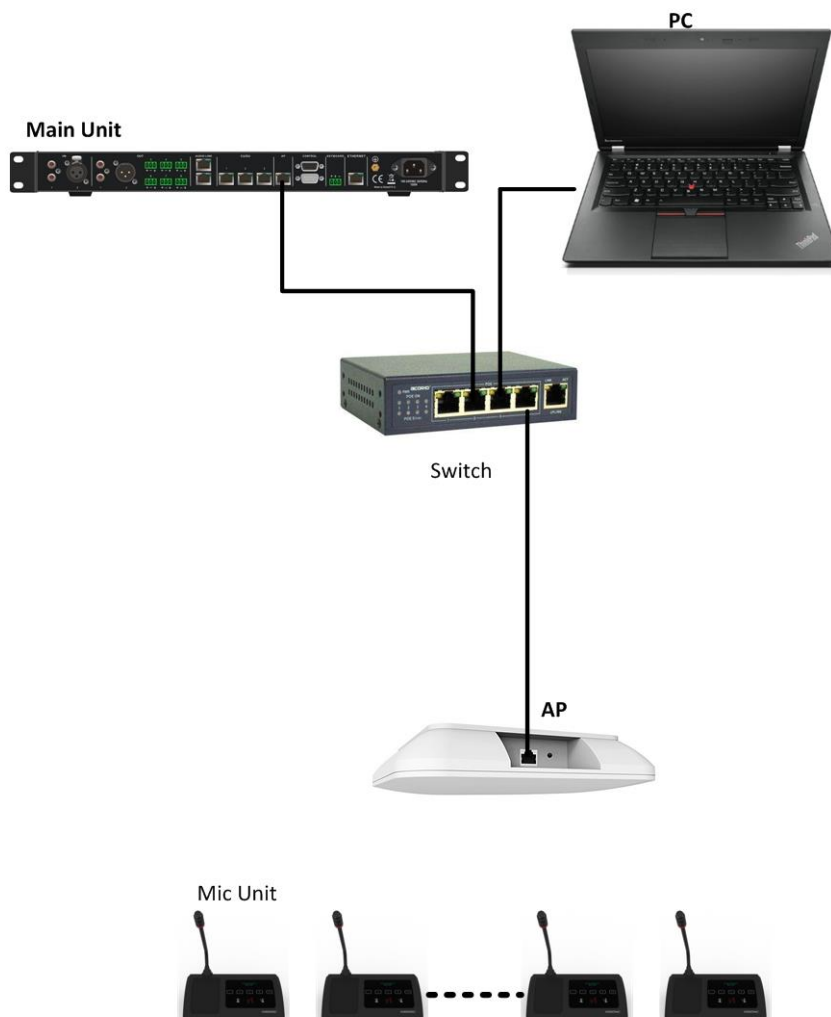

Test and Installation Connection (Conference system is working)



6.4.2 Set up AP SSID and Password

Step 1 Connect the PC to the AP by 2.4g Wi-Fi or LAN as one of above connections.

Step 2 Open the computer's network and Internet settings to change the adapter options, Ethernet right-click properties click on Internet protocol version 4 (TCP/IPv4), click on the properties below, set the same IP segment address for PC and AP. The default IP address for the For example, the network properties of our PC are as follows:

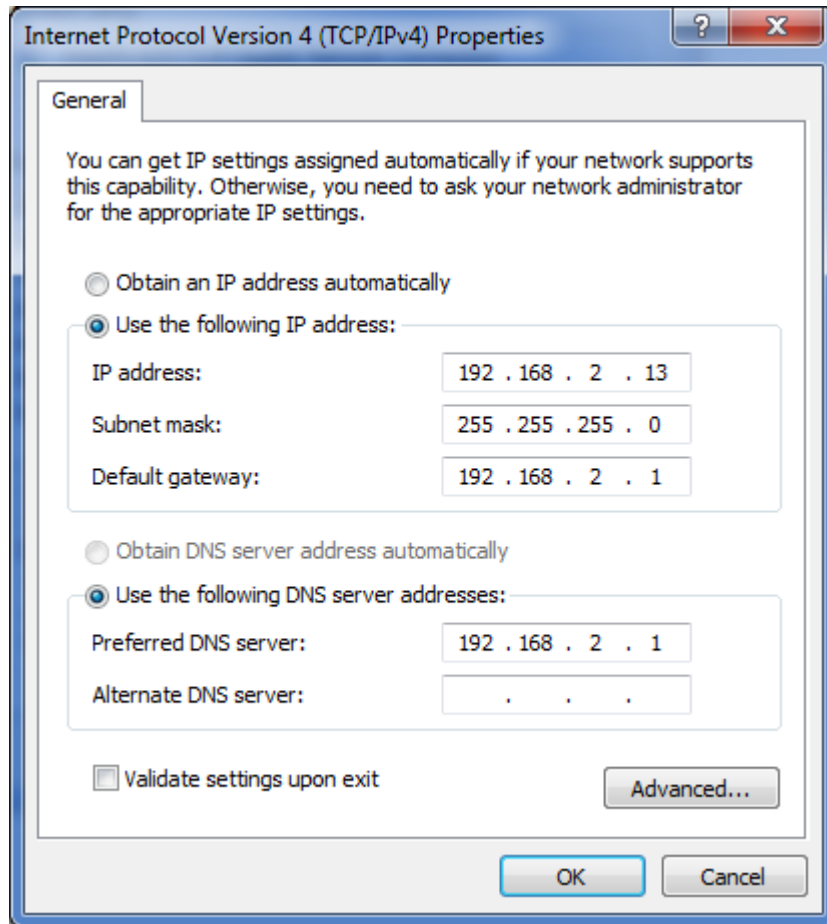

Step 3 We need to open the web browser, enter the default IP address 192.168.2.1 to get the following interface, enter the user name admin, password admin, and click Login.

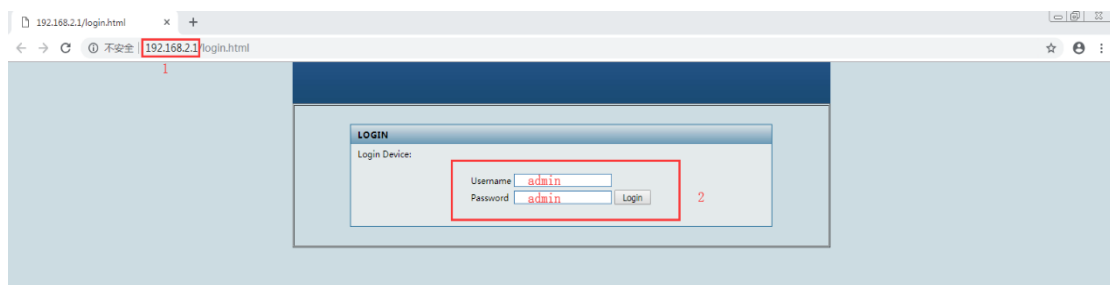

First click the Setting page under the navigation directory 5.8 G Configuration on the left side



to set the wireless network name to be consistent with the SSID name set by the conference host. As shown in the figure, multiple names can be set. For example, we add the name "WIFI_". After setting, click Submit at the bottom of the page for 15 seconds for upload and saving.

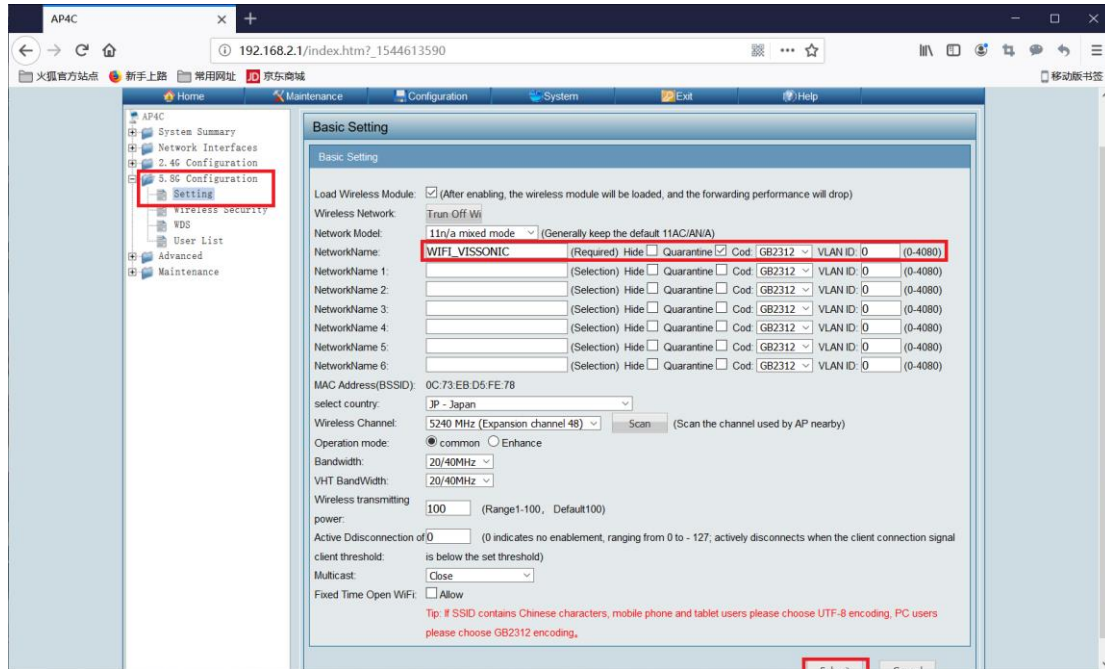

Then click on the Wireless Security settings in the navigation directory, select the wireless network name we uploaded before in the figure, set the wireless network password in the Share Key, and finally click the Submit upload below to save, the meeting unit has the display date and time, that is, the connection setting is successful.

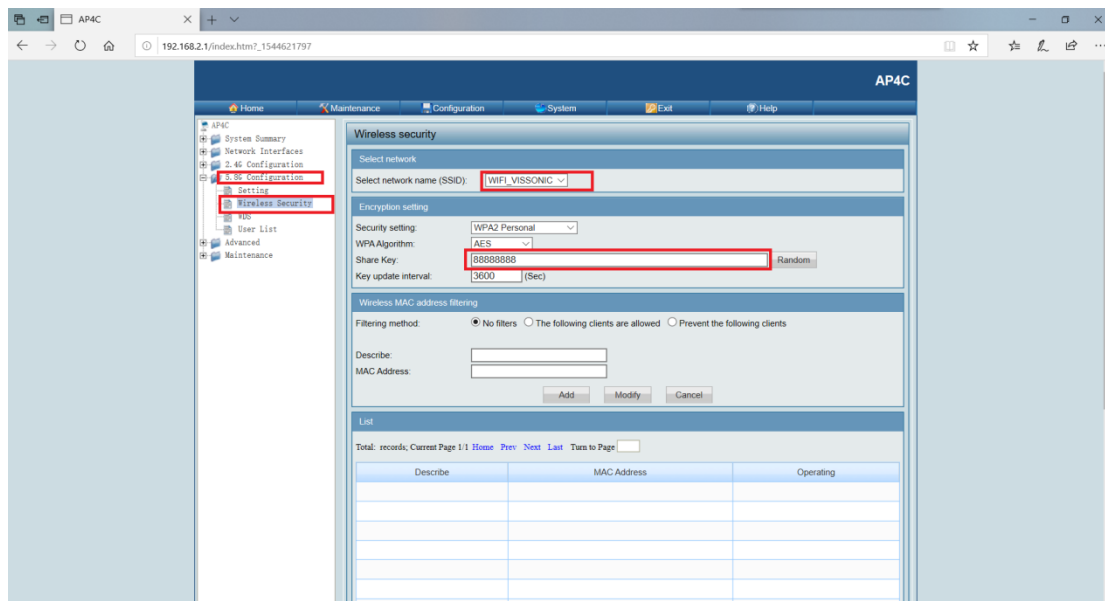



7. Operation

7.1 E-DCP2000 conference processor

When you start the conference processor, the display will show 'Initializing...'.The display then shows the main screen.

Main screen

U n i t : 0 0 0 1
M I C : O v e r r i d e / 1

The screen will display as above picture, including the information of total contribution units are connected to the system '0001' to '4000', MIC mode 'Override, Voice, Open, Apply' and the maximum active number '1, 2,4,6'.

MIC mode

On the main screen, press the button '▽' and directly enter the sub-menu of MIC mode to set the microphone mode. When the conference processor is connected to the PC, you also can set the microphone mode from the PC software.

Menu item	Value	Description
MIC mode	Override Open Voice Apply	The microphone mode of CLEACON conference system

Mode	Description
Override	In the override mode, delegates can activate their microphones with the microphone button on their contribution device. When the maximum number of delegates speak, the next delegate that activates his or her microphone automatically deactivates the microphone that was activated for the longest time.
Open	In the open mode, delegates can enable their microphones with the microphone button on their contribution units. When the maximum number of delegates speaker, the next delegate that enables his or her microphone is added to a request-to-speak list. The microphone is not enable until another delegate disables his or her microphone.
Voice	In the voice mode, the unit will be activated by the voice and no

EIKI

	need the press the MIC button.
Apply	In the apply mode, delegates can apply to enable their microphones with the microphone button on their contribution units and the green LED on MIC will be on. When the chairman unit press the APROVAL button to enable the applying delegate microphone according to the applying order. When the maximum number of delegates speaker, the system allowing the same maximum number of applying microphone on the waiting list.

Active MIC

On the main screen, press the button '△' and directly enter the sub-menu of Active MIC mode to set the active MIC number.





Menu item	Value	Description
Active MIC	1,2,4,6	Limited the max number of active microphone.

Monitoring -Unit information





Menu item	Value	Description
UNIT	0000~4000	Show the quantity of delegates/chairman units that connected to the system and help to check the system fault.

7.3 Simple interpreter desk E-DIC-T

Refer to the 6.2.2 and set the unit E-DIC-T as the interpreter unit. Please check the display and operation.

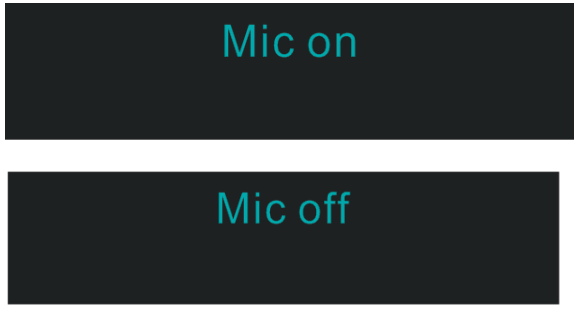
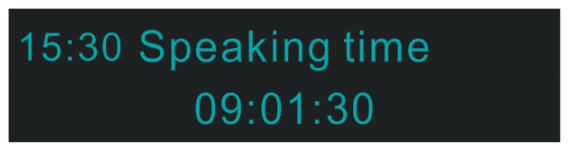
Screen	Description
	<p>Main screen, 'Interpreter unit'-Unit type 'Out: 01 ENG' show the interpreter output to channel number and language name.</p> <p>Press the channel buttons   to change the output channel.</p> <p>Volume bar to show the volume level to speaker and headphone and press the volume buttons   to adjust it.</p>

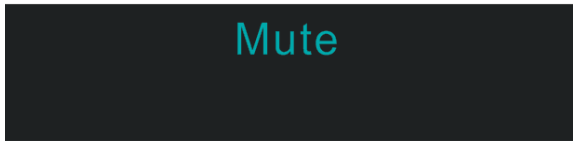
EIKI

	Press the MIC button  to turn on/off the microphone.
	Show the `speaking time`  Digital clock show the current time.
	Press the button  and hold for mute for cough, release the button to unmute.

7.4 Chairman unit and delegate unit display and operation

Microphones

The colors of the LEDs of the microphone buttons, the LED ring of MIC and display show the condition of the microphone that connected to the discussion unit.

MIC button color	LED ring color	Display character	Condition
Red(on)	Red(on)	Mic on	Microphone enabled
White(off)	Green(on)	Applying to speak Please wait...	Request to speak

7.5 Default Setting On E-DCP2000-W, E-AP4C and E-WDC-T/E-WDD-T

Under the default setting on AP, main unit and delegate unit, the wireless conference system can work together automatically. If necessary, we set the whole system to default setting by following steps.

Step 1 Set the default setting on main unit E-DCP2000

Menu->Default->Enter (Default)

Step 2 Press the volume - and + button at the same time when the unit reboot enter the bellowing interface.



Reset to default settings

Confirm

Exit

Press 'ENTER' button to confirm and set it successfully.

SSID and Password
updated successfully

Step 3 Set the default setting on the AP E-AP4C

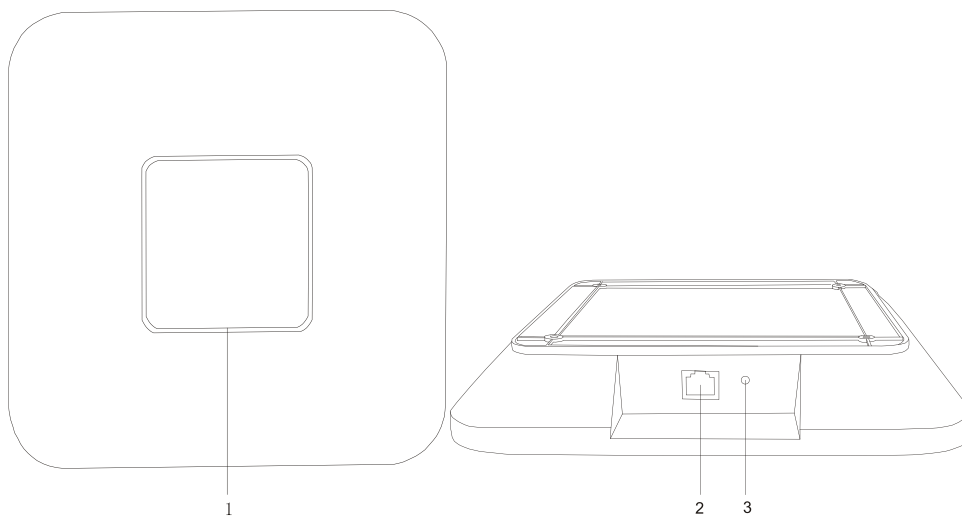

3. Reset button

Press the reset key on the back of the AP for about 10 seconds, the indicator is off, release the reset key. Press the reset key long again, the indicator light begins to flicker, and the AP has returned to the factory settings.

Note:

1. Switches do not recommend connecting to other devices, only hosts and up to 4E-AP4C.
2. AP has been upgraded to the factory, in general, it is not recommended to restore the factory settings, after the reset needs to carry out system upgrades.



8. Shakedown test

Generally we do not need to set up the host and unit, the wireless conference system can be used after the system is connected. The unit can display the current time, the host computer connected to the audio system, there is sound output.

1. Adjust the main volume knob of the front board of the conference host, control the output gain, cooperate with the peripheral equipment, and realize the picking distance required by the project under the premise of preventing whistling.

2. The engineer can set the meeting mode of the host computer and the maximum number of microphone switches according to the needs of the meeting factory, and refer to the instructions for other settings.

When we turn on the conference processor, the display displays "Initializing." After 3 seconds, the main screen menu is displayed.

Main screen

```
Unit: 0001
MIC: Override / 1
```

The main screen is shown in the figure above, including the number of conference microphones connected online ($001 \leq 4000$), the current mode of discussion: Override first-in-first-out, Voice control, Open, Apply application maximum number of delegates: 1, 2, 4, and 6

At 1, 2, there can be 1 chairman's module and 4, 6 can open 2 chairman's module.

The following is an example of setting the maximum number of microphones turned on, and the meeting mode settings are the same.

1. From the main screen, press the 'Enter' button to get the following menu.

```
Menu
-> MIC Mode
```

2. Press the 'button' to select the maximum number of microphones on menu ActiveMIC.

```
Menu
-> Active MIC
```



3. Press the 'ENTER' button to enter the menu.

```
A c t i v e M I C : 1
- > 1   2   4   6
```

4. Press the 'button' to select the parameter'6'.

```
A c t i v e M I C : 1
      1   2   4- > 6
```

5. Press 'ENTER' to confirm the current parameter'6 / and make the parameter take effect, displayed as ActiveMIC: 6.

```
A c t i v e M I C : 6
      1   2   4- > 6
```

6. Press 'ESC' to return to the home screen.

```
U n i t : 0 0 0 1
M I C : 0 v e r r i d e / 1
```

3. Change the AP band according to the field wireless network environment.

For specific operations, see 6.3 AP band configuration.